

SMFL Single and Dual DC/DC Converters

28 VOLT INPUT – 65 WATT

FEATURES

- Fully qualified to Class H or K
- -55° to +125°C operation
- 16 to 40 VDC input
- Fully Isolated
- Magnetic feedback
- Fixed frequency, 600 kHz typical
- Topology – Single Ended Forward
- 50 V for up to 120 ms transient protection
- Inhibit input side and output side
- Sync function
- Output trim on single output models
- Indefinite short circuit protection
- Remote sense on single output models
- Up to 85% efficiency / 43 W/in³
- Parallelable up to 148 watts



MODELS	
VDC OUTPUT	
SINGLE	DUAL
3.3	±5
5	±12
12	±15
15	

DESCRIPTION

The SMFL Series™ 28-volt DC/DC converters are rated up to 65 watts output power over a -55° to +125°C temperature range with a 28 Vdc nominal input. On dual output models up to 70% of the rated output power can be drawn from either the positive or negative outputs. Current sharing allows the units to be paralleled for total power of up to 148 watts. The welded, hermetically sealed package is only 3.0 x 1.5 x 0.40 inches, giving the series an overall power density of up to 45 watts per cubic inch.

SCREENING

SMFL converters offer the following screening options: Space Prototype (O), Class H, or Class K. Radiation tolerant to Radiation Hardness Assurance (RHA) levels of “-” (O) or “R”, per MIL-STD-38534. Interpoint model numbers use an “O” in the RHA designator position to indicate the “-” (dash) Radiation Hardness Assurance level of MIL-PRF-38534, which is defined as “no RHA”. See “Class H and K, QML Screening” tables for more information.

DESIGN FEATURES

SMFL Series converters are switching regulators that use a quasi-square wave, single ended forward converter design with a constant switching frequency of 600 kHz typical.

Isolation between input and output circuits is provided with a transformer in the forward path and a wide bandwidth magnetic coupling in the feedback control loop. The SMFL uses a unique dual loop feedback technique that controls output current with an inner feedback loop and an output voltage with a cascaded voltage mode feedback loop. The additional secondary current mode feedback loop improves transient response in a manner similar to primary current mode control and allows for ease of paralleling, but without the cost and complexity.

The constant frequency, pulse-width modulated converters use a quasi-square wave single-ended forward design. Tight load regulation is achieved through a wide-bandwidth magnetic feedback circuit. The output voltage on single SMFL models can be trimmed to a specific output voltage by adding an external resistor.

INHIBIT

The SMFL Series converters have two TTL compatible inhibit terminals (INH1 and INH2) that can be used to disable power conversion, resulting in a very low quiescent input current and no generation of switching noise. An open collector TTL compatible low (<0.8 volts) is required to inhibit the converter between INH1 (pin 4) and Input Common (pin 2). An open collector TTL compatible low (<0.5 volts) is required to inhibit the converter between INH2 (pin 12) and Output Common (pin 8). The application of intermediate voltages to these pins (1.5 to 10.5 volts) should be avoided.

SYNC

Converters may be synced to an external clock (525 to 675 kHz) or to one another by using the sync in or out pins. The nominal free-run switching frequency is 600 kHz.

CURRENT AND PARALLEL OPERATION

Multiple single output SMFL converters may be used in parallel to drive a common load. In this mode of operation the load current is shared by two or three SMFL converters. In current sharing mode, one SMFL converter is designated as a master. The SLAVE pin (pin 11) of the master is left unconnected and the MSTR/INH2 pin (pin 12) of the master is connected to the SLAVE pin (pin 11) of the slave units. The units designated as slaves have the MSTR/INH2 pin (pin 12) connected to the SNS RTN pin (pin 9). Note that synchronizing the units together is not required for current sharing operation. A second slave unit may be placed in parallel with a master and slave; this requires the TRI pin (pin 3) of the master unit to be connected to the SNS RTN pin (pin 9). See Figure 2 for a block diagram of parallel connections.

When paralleled, 76% of the total combined power ratings of the SMFL converters are available at the load. Overload and short circuit performance are not adversely affected during parallel operation.

SMFL Single and Dual DC/DC Converters

28 VOLT INPUT – 65 WATT

SINGLE OUTPUT MODELS CONNECTION DIAGRAMS - SENSE AND PARALLEL

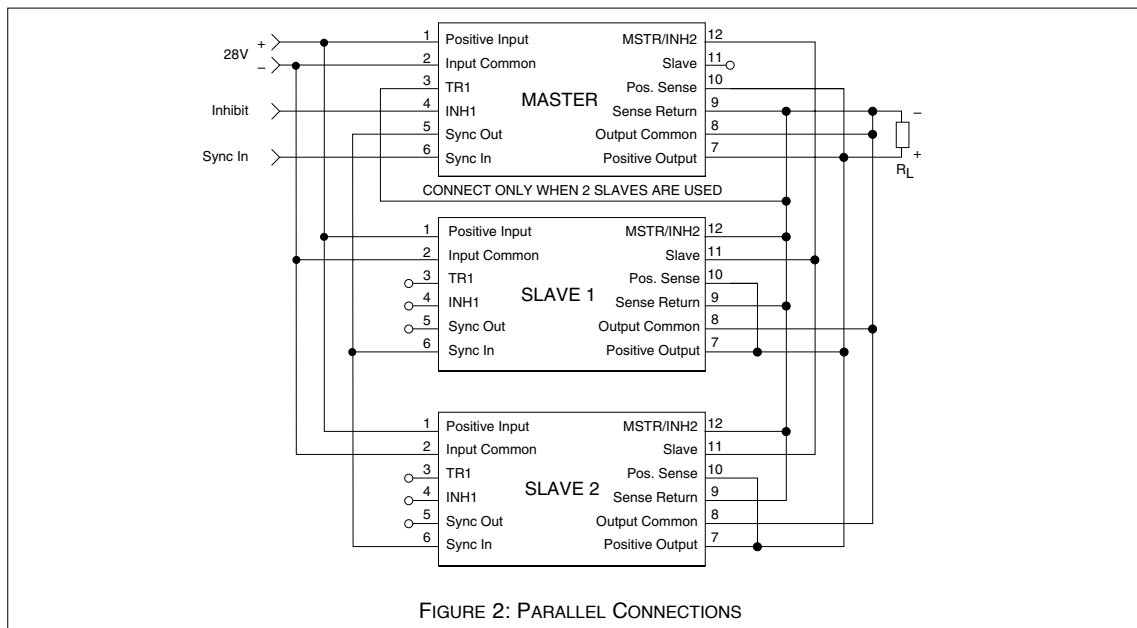
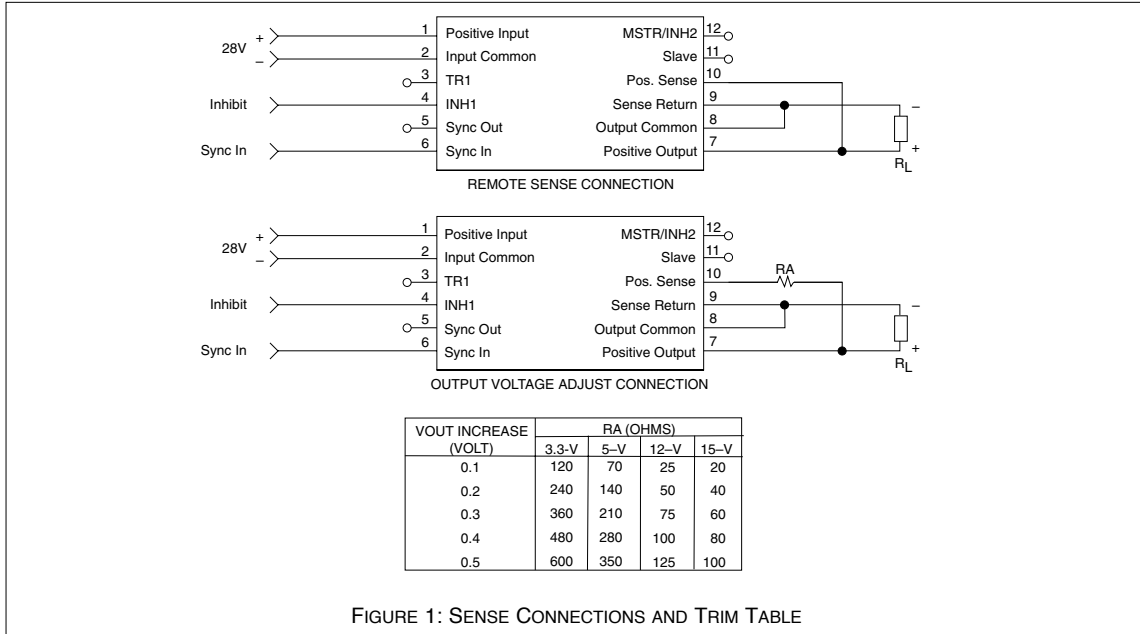

SMFL Single and Dual DC/DC Converters

28 VOLT INPUT – 65 WATT

OPERATING CONDITIONS AND CHARACTERISTICS

Input Voltage Range

- 16 to 40 VDC continuous
- 50 V for 120 ms transient

Output Power

- 40 to 65 watts depending on model

Lead Soldering Temperature (10 sec per lead)

- 300°C

Storage Temperature Range (Case)

- -65°C to +150°C

Power Dissipation (Pd)

- 14 watts (16 watts SMFL2805S, SMFL2805D)

Case Operating Temperature (Tc)

- -55°C to +125°C full power

Derate Output Power/Current

- MFL283R3S: linearly from 100% at 100 °C to 80% at 125 °C

Output Voltage Temperature Coefficient

- 100 ppm/°C typical

Input to Output Capacitance

- 150 pF, typical

Current Limit

- 125% of full load typical

Isolation

- 100 megohm minimum at 500 V

Audio Rejection

- 50 dB typical

Conversion Frequency (-55°C to 125°C)

- Free run mode 600 kHz typical
- 525 kHz. min, 675 kHz max

Inhibit Pin Voltage (unit enabled)

- INH1 = 9 to 12 V, INH2 = 6 to 9 V

SYNC IN AND INHIBIT (INH1, INH2)

Sync In (525 to 675 kHz)

- Duty cycle 40% min, 60% max
- Logic low 0.8 V max
- Logic high 4.5 V min, 5 V max
- Referenced to input common

Sync Out

- Referenced to input common

Inhibit (INH1, INH2) TTL Open Collector

- Logic low (output disabled)
 - INH1 referenced to input common
 - Logic low 0.8 V max
 - Inhibit pin current 10 mA max
 - INH2 referenced to output common
 - Logic low 0.5 V max
 - Inhibit pin current 5 mA max
- Logic high (output enabled)
 - Open collector

MECHANICAL AND ENVIRONMENTAL

Size (maximum)

3.005 x 1.505 x 0.400 inches (76.33 x 38.23 x 10.16 mm)
 See case U for dimensions.
 Case options V, W, Y, and Z are available by special order.

Weight (maximum)

86 grams

Screening

Space Prototype (O), Class H, or Class K

Radiation tolerant to Radiation Hardness Assurance (RHA) levels of “-” (O) or “R”, per MIL-STD-38534. Interpoint model numbers use an “O” in the RHA designator position to indicate the “-” (dash) Radiation Hardness Assurance level of MIL-PRF-38534, which is defined as “no RHA”.

See “Class H and K, QML Screening” tables for more information.

Available configurations: OO, HO, HR, KR

SMFL Single and Dual DC/DC Converters

28 VOLT INPUT – 65 WATT

PIN OUT

Pin	Single Output	Dual Output
1	Positive Input	Positive Input
2	Input Common	Input Common
3	Triple (TRI)	Triple (TRI)
4	Inhibit 1 (INH1)	Inhibit 1 (INH1)
5	Sync Out	Sync Out
6	Sync In	Sync In
7	Positive Output	Positive Output
8	Output Common	Output Common
9	Sense Return	Negative Output
10	Positive Sense	No connection
11	Slave	Slave
12	Master / Inhibit 2	Master / Inhibit 2

PINS NOT IN USE

TR1	Leave unconnected
Master	Leave unconnected
Slave	Leave unconnected
Sync In	Connect to Input Common
Inhibit (INH1)	Leave unconnected
Inhibit (INH2)	Leave unconnected
Sync Out	Leave unconnected
Sense Lines	Must be connected to appropriate outputs

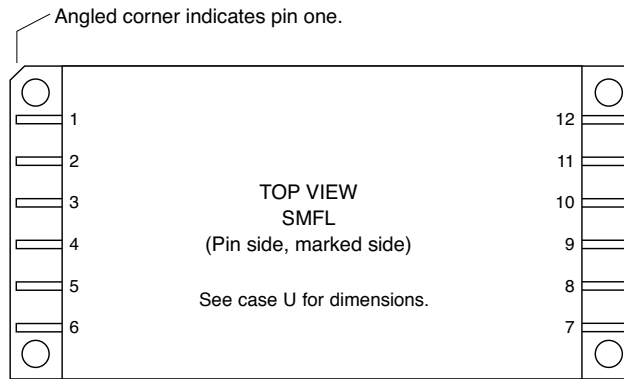
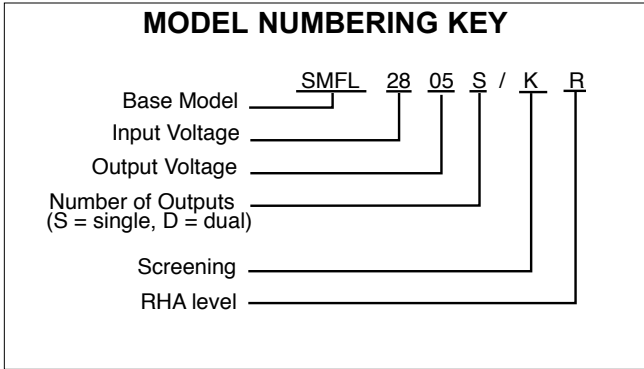

FIGURE 3: PIN OUT

SMFL Single and Dual DC/DC Converters

28 VOLT INPUT – 65 WATT



SMD NUMBERS

STANDARD MICROCIRCUIT DRAWING (SMD)	SMFL SERIES SIMILAR PART
IN PROCESS	SMFL283R3S/HO
5962-9316302HXC	SMFL2805S/HO
5962-9316202HXC	SMFL2812S/HO
5962-9316102HXC	SMFL2815S/HO
IN PROCESS	SMFL2805D/HO
IN PROCESS	SMFL2812D/HO
5962-9319302HXC	SMFL2815D/HO

The SMD number shown is for Class H screening, non-flanged, and no Radiation Hardness Assurance (RHA) level. See the SMD for the numbers for other screening and RHA levels. For exact specifications for an SMD product, refer to the SMD drawing. Call your Interpoint representative for status on the SMFL SMD releases which are "in process." SMDs can be downloaded from:
<http://www.dscc.dla.mil/programs/smcr>

MODEL SELECTION

SMFL28 _____ _____ _____ / _____
Base model *V_{out} value* *number of outputs* *case option* *screening*

Choose one from each of the following rows

V_{out} value singles: 3R3, 5, 12, 15 duals: 5, 12, 15
 "R" = decimal point, 3R3 = 3.3VDC

Number of outputs S (single) or D (dual)

Case option standard (case U, leave blank) V, W, Y and Z available by special order

Screening OO* - Space prototype, HO, HR, KR

*Interpoint model numbers use an "O" in the RHA designator position to indicate the "-" (dash) Radiation Hardness Assurance level of MIL-PRF-38534, which is defined as "no RHA"

SMFL Single and Dual DC/DC Converters

28 VOLT INPUT – 65 WATT

Electrical Characteristics: -55°C to +125°C Tc, 28 VDC Vin, 100% load, RHA level O, unless otherwise specified.

SINGLE OUTPUT MODELS		SMFL283R3S			SMFL2805S			SMFL2812S			SMFL2815S			UNITS
PARAMETER	CONDITIONS	MIN	TYP	MAX	MIN	TYP	MAX	MIN	TYP	MAX	MIN	TYP	MAX	
OUTPUT VOLTAGE	TC = 25°C	3.26	3.30	3.34	4.95	5.00	5.05	11.88	12.00	12.12	14.85	15.00	15.15	VDC
OUTPUT CURRENT	V _{IN} = 16 TO 40 VDC	0	—	12.12	0	—	10	0	—	5	0	—	4.33	A
OUTPUT POWER	V _{IN} = 16 TO 40 VDC	0	—	40	0	—	50	0	—	60	0	—	65	W
OUTPUT RIPPLE 10 kHz - 2 MHz	TC = 25°C	—	10	35	—	15	35	—	30	75	—	30	85	mV p-p
	TC = -55°C TO +125°C	—	10	50	—	30	50	—	45	100	—	45	110	
LINE REGULATION	V _{IN} = 16 TO 40 VDC	—	0	20	—	0	20	—	0	20	—	0	20	mV
LOAD REGULATION	NO LOAD TO FULL	—	—	40	—	—	20	—	—	20	—	—	20	mV
INPUT VOLTAGE	CONTINUOUS	16	28	40	16	28	40	16	28	40	16	28	40	VDC
	TRANSIENT ^{1, 2} 50 ms	—	—	50	—	—	50	—	—	50	—	—	50	V
INPUT CURRENT	NO LOAD	—	70	100	—	70	120	—	50	100	—	50	100	mA
	INHIBITED – INH1	—	9	14	—	9	14	—	9	14	—	9	14	
	INHIBITED – INH2	—	35	70	—	35	70	—	35	70	—	35	70	
INPUT RIPPLE	10 kHz - 10 MHz	—	30	50	—	30	50	—	30	50	—	30	50	mA p-p
EFFICIENCY	TC = 25°C	70	—	—	75	78	—	81	84	—	82	85	—	%
LOAD FAULT	SHORT CIRCUIT POWER DISSIPATION TC = 25°C	—	12.5	16	—	12.5	16	—	10	16	—	10	16	W
	RECOVERY ¹	—	1.5	4	—	1.5	4	—	1.5	4	—	1.5	4	ms
STEP LOAD RESPONSE	50% - 100% - 50% TRANSIENT	—	200	300	—	250	350	—	450	600	—	500	600	mV pk
	RECOVERY ^{1, 3}	—	1.5	3.0	—	1.5	3.0	—	1.5	3.0	—	1.5	3.0	ms
STEP LINE RESPONSE ^{1, 3}	16 - 40 - 16 VDC TRANSIENT ⁴	—	250	300	—	250	300	—	250	400	—	250	400	mV pk
	RECOVERY	—	200	600	—	200	300	—	200	300	—	200	300	ms
START-UP ⁵	DELAY	—	3.5	6	—	3.5	6	—	3.5	6	—	3.5	6	ms

Notes

1. Guaranteed by design, not tested.

2. Unit will shut down above approximately 45 V but will be undamaged and will restart when voltage drops into normal range.

3. Recovery time is measured from application of the transient to point at which V_{out} is within 1% of final value.

4. Transition time > 10 μs.

5. Tested on release from inhibit.

6. Shall not compromise DC performance.

7. SMFL283R3S current and power are at 25°C only.

SMFL Single and Dual DC/DC Converters

28 VOLT INPUT – 65 WATT

Electrical Characteristics: -55°C to +125°C Tc, 28 VDC Vin, 100% load, RHA level O, unless otherwise specified.

DUAL OUTPUT MODELS			SMFL2805D			SMFL2812D			SMFL2815D			UNITS
PARAMETER	CONDITIONS		MIN	TYP	MAX	MIN	TYP	MAX	MIN	TYP	MAX	
OUTPUT VOLTAGE	TC = 25°C	+ V _{OUT}	4.95	5.00	5.05	11.88	12.00	12.12	14.85	15.00	15.15	VDC
		- V _{OUT}	4.92	5.00	5.08	11.82	12.00	12.18	14.77	15.00	15.23	
OUTPUT CURRENT ²	VIN = 16 TO 40 VDC	EACH OUTPUT	0	—	7	0	—	3.5	0	—	3.03	A
		TOTAL OUTPUT	0	—	10	0	—	5	0	—	4.33	
OUTPUT POWER	VIN = 16 TO 40 VDC		0	—	50	0	—	60	0	—	65	W
OUTPUT RIPPLE ± V _{OUT}	10 kHz - 2 MHz		—	50	100	—	50	120	—	50	150	mV p-p
LINE REGULATION	VIN = 16 TO 40 VDC	+ V _{OUT}	—	0	50	—	0	50	—	0	50	mV
		- V _{OUT}	—	25	100	—	25	100	—	25	100	
LOAD REGULATION	NO LOAD TO FULL	+ V _{OUT}	—	0	50	—	10	50	—	10	50	mV
		- V _{OUT}	—	25	100	—	50	120	—	150	150	
CROSS REGULATION TC = 25°C	SEE NOTE 3		—	5	8	—	2	4	—	2	4	%
	SEE NOTE 4		—	3	6	—	2	4	—	2	4	
INPUT VOLTAGE	CONTINUOUS		16	28	40	16	28	40	16	28	40	VDC
	TRANSIENT ^{1, 5} 50 ms		—	—	50	—	—	50	—	—	50	V
INPUT CURRENT	NO LOAD		—	50	120	—	50	100	—	50	100	mA
	INHIBITED-INH1		—	9	14	—	9	14	—	9	14	
	INHIBITED-INH2		—	35	70	—	35	70	—	35	70	
INPUT RIPPLE CURRENT	10 kHz - 10 MHz		—	30	50	—	30	50	—	30	80	mA p-p
EFFICIENCY TC = 25°C	BALANCED LOAD		75	78	—	81	84	—	82	85	—	%
LOAD FAULT TC = 25°C	SHORT CIRCUIT POWER DISSIPATION		—	12.5	16	—	10	14	—	10	14	W
	RECOVERY ¹		—	1.5	4.0	—	1.5	4.0	—	1.5	4.0	ms
STEP LOAD RESPONSE ± V _{OUT}	50% - 100% - 50% TRANSIENT		—	250	350	—	450	600	—	500	600	mV pk
	RECOVERY ^{1, 7}		—	1.5	3.0	—	1.5	3.0	—	1.5	3.0	ms
STEP LINE RESPONSE ^{1, 6} ± V _{OUT}	16 - 40 - 16 VDC TRANSIENT ⁷		—	250	300	—	250	400	—	250	400	mV pk
	RECOVERY		—	200	300	—	200	300	—	200	300	ms
START-UP ⁸	DELAY		—	3.5	6	—	3.5	6	—	3.5	6	ms

Notes

1. Guaranteed by design, not tested.
2. Up to 70% of the total output power is available from either output providing the opposite output is simultaneously carrying 30% of the total power.
3. Effect on negative Vout from 50%/50% loads to 70%/30% or 30%/70% loads.
4. Effect on negative Vout from 50%/50% loads to 50% then 10% load on negative Vout.
5. Unit will shut down above approximately 45V but will be undamaged and will restart when voltage drops into normal range.
6. Recovery time is measured from application of the transient to point at which Vout is within 1% of final value.
7. Transition time > 10 μS.
8. Tested on release from inhibit.
9. Shall not compromise DC performance.

SMFL Single and Dual DC/DC Converters

28 VOLT INPUT – 65 WATT

Typical Performance Curves: 25°C Tc, 28 VDC Vin, 100% load, free run, unless otherwise specified.

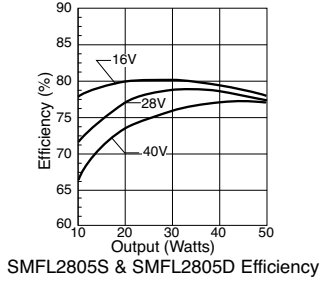

FIGURE 4

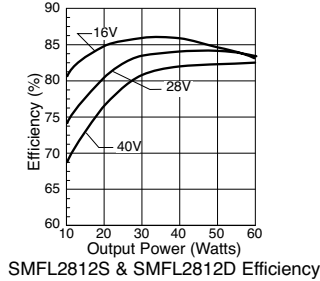

FIGURE 5

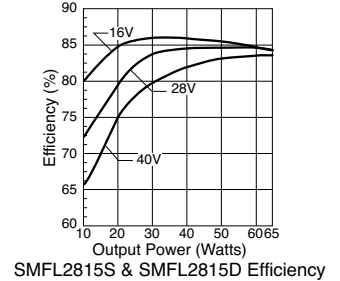

FIGURE 6

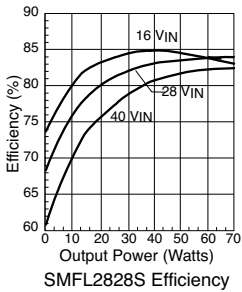

FIGURE 7

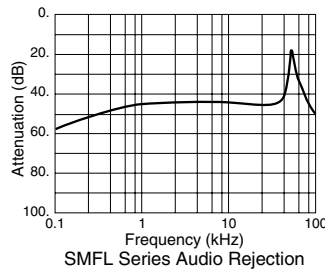

FIGURE 8

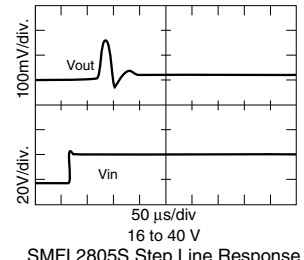

FIGURE 9

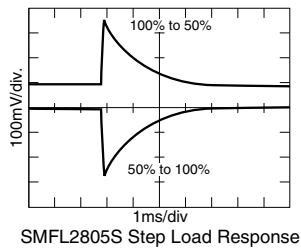

FIGURE 10

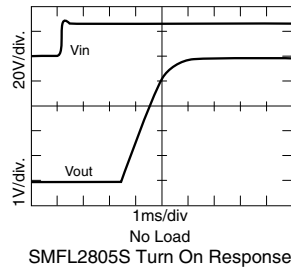

FIGURE 11

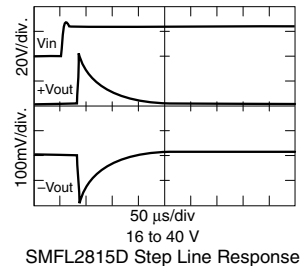

FIGURE 12

SMFL Single and Dual DC/DC Converters

28 VOLT INPUT – 65 WATT

Typical Performance Curves: 25°C Tc, 28 VDC Vin, 100% load, free run, unless otherwise specified.

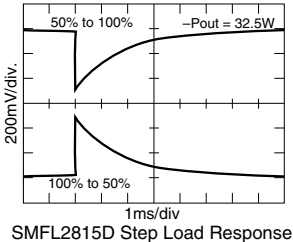

FIGURE 13

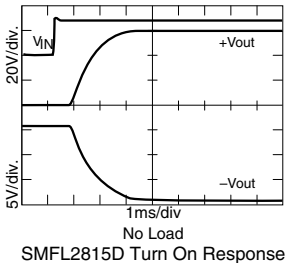

FIGURE 14

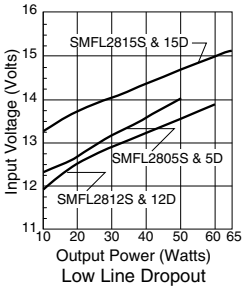
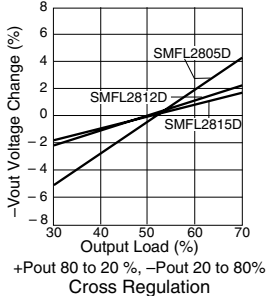

FIGURE 16

SMFL Single and Dual DC/DC Converter Cases

28 VOLT INPUT – 65 WATT

TOP VIEW CASE U Flanged case, short-leaded

*Does not require designator in Case Option position of model number.

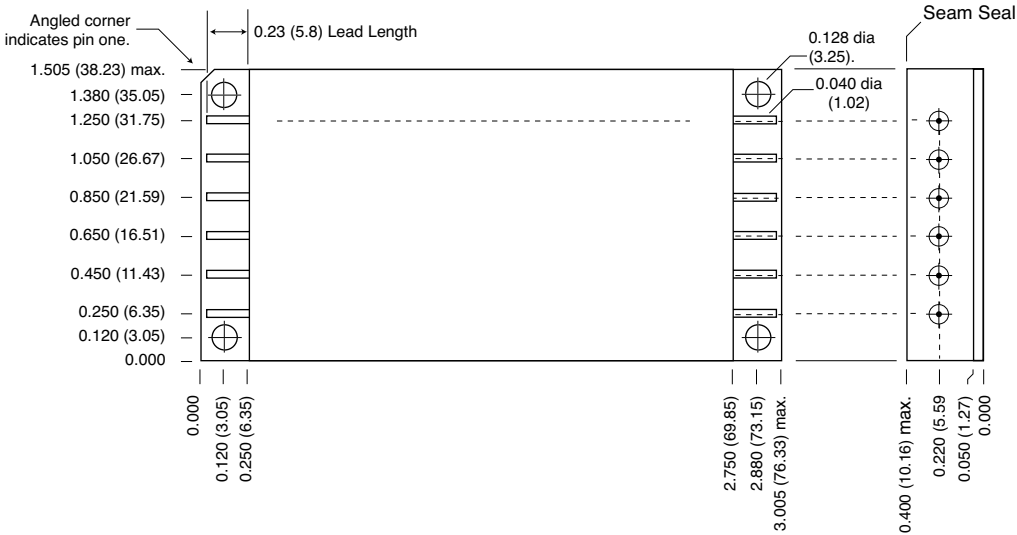

Case dimensions in inches (mm)
 Tolerance ± 0.005 (0.13) for three decimal places
 ± 0.01 (0.3) for two decimal places
 unless otherwise specified

CAUTION
 Heat from reflow or wave soldering may damage the device.
 Solder pins individually with heat application not exceeding 300°C for 10 seconds per pin

Materials
 Header Cold Rolled Steel/Nickel/Gold
 Cover Kovar/Nickel
 Pins #52 alloy/Nickel/Gold; compression glass seal

Case U, Rev C, 20060302
 Please refer to the numerical dimensions for accuracy. All information is believed to be accurate, but no responsibility is assumed for errors or omissions. Interpoint reserves the right to make changes in products or specifications without notice.
 Copyright © 1999-2006 Interpoint Corp. All rights reserved.

FIGURE 17: CASE U

SMFL Single and Dual DC/DC Converters

28 VOLT INPUT – 65 WATT

CLASS H AND K, QML SCREENING: ELEMENT EVALUATION

ELEMENT EVALUATION TEST PERFORMED (COMPONENT LEVEL)	SPACE PROTOTYPE O NON-QML ¹		CLASS H QML		CLASS K QML	
	M/S ²	P ³	M/S ²	P ³	M/S ²	P ³
	Element Electrical	yes	no	yes	yes	yes
Element Visual	no	no	yes	yes	yes	yes
Internal Visual	no	no	yes	no	yes	no
Temperature Cycling	no	no	no	no	yes	yes
Constant Acceleration	no	no	no	no	yes	yes
Interim Electrical	no	no	no	no	yes	no
Burn-in	no	no	no	no	yes	no
Post Burn-in Electrical	no	no	no	no	yes	no
Steady State Life	no	no	no	no	yes	no
Voltage Conditioning Aging	no	no	no	no	no	yes
Visual Inspection	no	no	no	no	no	yes
Final Electrical	no	no	yes	yes	yes	yes
Wire Bond Evaluation ⁴	no	no	yes	yes	yes	yes
SEM	no	no	no	no	yes	no
SLAM™/C-SAM: Input capacitors only (Add'l test, not req. by H or K)	no	no	no	yes	no	yes

Notes:

1. Non-QML products do not meet all of the requirements of MIL-PRF-38534
2. M/S = Active components (Microcircuit and Semiconductor Die)
3. P = Passive components
4. Not applicable to EMI filters that have no wirebonds

Definitions:

Element Evaluation: Component testing/screening per MIL-STD-883 as determined by MIL-PRF-38534
SEM: Scanning Electron Microscopy
SLAM™: Scanning Laser Acoustic Microscopy
C-SAM: C - Mode Scanning Acoustic Microscopy

SMFL Single and Dual DC/DC Converters

28 VOLT INPUT – 65 WATT

CLASS H AND K, QML SCREENING: ENVIRONMENTAL SCREENING

ENVIRONMENTAL SCREENING TEST PERFORMED (END ITEM LEVEL)	SPACE PROTOTYPE O NON-QML ¹	CLASS H, QML	CLASS K, QML
Non-destruct bond pull ² Method 2023	no	yes ³	yes
Pre-cap Inspection Method 2017, 2032	yes	yes	yes
Temperature Cycle (10 times) Method 1010, Cond. C, -65°C to 150°C, ambient	yes	yes	yes
Constant Acceleration Method 2001, 3000 g	yes	yes	yes
PIND Test Method 2020, Cond. A	no	yes ³	yes
Radiography Method 2012	n/a	n/a	yes
Pre burn-in test	yes	yes	yes
Burn-in Method 1015, 125°C case, typical			
96 hours	yes	no	no
160 hours	no	yes	no
2 x 160 hour (includes mid BI test)	no	no	yes
Final electrical test MIL-PRF-38534 Group A, Subgroups 1 through 6 -55°C, +25°C, +125°C case	yes	yes	yes
Hermeticity test			
Fine Leak, Method 1014, Cond. A	yes	yes	yes
Gross Leak, Method 1014, Cond. C	yes	yes	yes
Final visual inspection Method 2009	yes	yes	yes

Test methods are referenced to MIL-STD-883 as determined by MIL-PRF-38534.

Notes:

1. Non-QML products do not meet all of the requirements of MIL-PRF-38534
2. Not applicable to EMI filters that have no wirebonds
3. Not required by DSCC but performed to assure product quality.

SMFL Single and Dual DC/DC Converters

28 VOLT INPUT – 65 WATT

CLASS H AND K, QML SCREENING: RADIATION

PRODUCT LEVEL AVAILABILITY	ENVIRONMENTAL SCREENING LEVELS		
	SPACE PROTOTYPE O ² non-QML ³	CLASS H QML	CLASS K QML
RADIATION HARDNESS ASSURANCE LEVELS O: Standard, no radiation guarantee ²	OO	HO	Not available
R: Radiation hardened – Tested lots Up to 100 K Rads (Si) total dose SEU guarantee up to 40 MeV	Not available	HR ⁴	KR ⁴

Notes:

1. Our EMI filters are designed exclusively with passive components providing maximum tolerance for space environment requirements
2. Interpoint model numbers use an "O" in the RHA designator position to indicate the "-" (dash) Radiation Hardness Assurance level of MIL-PRF-38534, which is defined as "no RHA"
3. Non-QML products do not meet all of the requirements of MIL-PRF-38534
4. Redmond site, Interpoint, has a DSCC approved radiation plan. Our SMD products with RHA level "R" code meet DSCC requirements