

- ▶ Low Voltage HCMOS
- ▶ 3.2 x 2.5 mm Footprint
- ▶ Low current consumption
- ▶ Pb Free/RoHS Compliant

ECS-2325/2333

SMD CLOCK OSCILLATOR

ECS-2325 (2.5V) and ECS-2333 (3.3V) subminiature SMD oscillators. Ideal for today's high density applications.

OPERATING CONDITIONS / ELECTRICAL CHARACTERISTICS

PARAMETERS	CONDITIONS	ECS-2325 (+2.5V)			ECS-2333 (+3.3V)			UNITS
		MIN	TYP	MAX	MIN	TYP	MAX	
Frequency Range		1.000		75.000	1.000		75.000	MHz
Operating Temperature	Standard	-10		+70	-10		+70	°C
	Extended (N Option)	-40		+85	-40		+85	°C
Storage Temperature		-55		+100	-55		+100	°C
Supply Voltage	VDD	+2.25	+2.5	+2.75	+2.97	+3.3	+3.63	VDC
Frequency Stability *	Option A			± 100			± 100	ppm
	Option B			± 50			± 50	ppm
	Option C			± 25			± 25	ppm
Input Current	0.75 to 20 MHz			5			7	mA
	20.1 to 40 MHz			9			13	mA
	40.1 to 60 MHz			11			19	mA
	60.1 to 75 MHz			14			24	mA
Stand-by Current	Pin 1 = VIL			10			10	µA
Output Symmetry	@ 50% VDD level			40/60			45/55	%
Rise and Fall Times	10% VDD to 90% level			10			10	ns
"0" level	VOL			10% VDD			10% VDD	VDC
"1" level	VOH	90% VDD			90% VDD			VDC
Output Load	CMOS			15			15	pF
Disable delay time				150			150	ns
Enable/Startup time				10			10	ms
Aging				± 5			± 5	ppm

* Note: Inclusive of 25°C tolerance, operating temperature, input voltage change, load change, shock and vibration.

DIMENSIONS (mm)

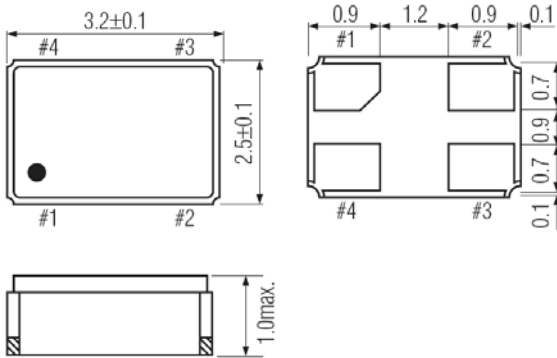

Figure 1) Top, Side and Bottom views

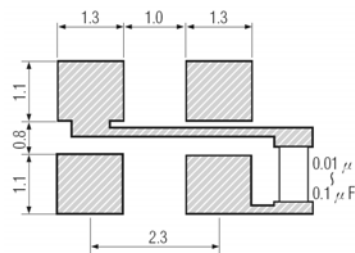

Figure 2) Suggested Land Pattern

Pin Connections

Pin #1	Tri-State
Pin #2	Ground
Pin #3	Output
Pin #4	VDD

Tri-State Control Voltage

Pad 1	Pad 3
Open	Oscillation
VIH 70% VDD Min	Oscillation
VIL 30% VDD Max	No Oscillation

Note: Internal crystal oscillation to be halted (Pin #1=VIL)

PART NUMBERING GUIDE: Example ECS-2333-200-BN

ECS	Series	Frequency Abbreviation	Stability	Temperature
	2325 = +2.5V 2333 = +3.3V	200 = 20.000 MHz See Frequency Abbreviations	A = ± 100 ppm B = ± 50 ppm C = ± 25 ppm	Blank = -10 ~ +70°C M = -20 ~ +70°C N = -40 ~ +85°C