



Spec. No.	PS-0701-007
Rev.	D

# PRODUCT SPECIFICATION

## Model No : CSHV-NL60SWG4-A2

Descriptions:
<ul style="list-style-type: none"> <li>• LED Type : High Power VEGA</li> <li>• LED Package : Lambertian</li> <li>• Emitting Color : White</li> <li>• Viewing Angle : 120°</li> <li>• Silicone LENS</li> </ul>



CUSTOMER APPROVED SIGNATURES	APPROVED BY	CHECKED BY	PREPARED BY

**CHINA SEMICONDUCTOR CORPORATION**  
Address:2FL. NO.909,Chung-Cheng Road,  
Chung-Ho City Taipei Hsien,Taiwan.

**OPTO PLUS TECHNOLOGIES CO.,LTD**  
Address:696 Shun jiang Rd.,Ji Shan St.Shaoxing,  
ZheJiang,China

Tel:886-2-2223-9696  
Fax:886-2-2223-9377

Tel:86-0575-88623888  
Fax:86-0575-88623112



Spec. No.	PS-0701-007
Rev.	D

**Model No : CSHV-NL60SWG4-A2**

**Features -**

1. High Luminous Output : 80 lm
2. Silicone Encapsulation
3. RoHs Compliant
4. Compatible Lead-Free Reflow Solder
5. ESD>8KV(HBM)
6. Standard Collimator Compatible
7. Low thermal resistance (junction to Case) : 10 °C/W

**Device Selection Guide -**

Part No.	Chip		LED Lens
	Material	Emitted Color	
CSHV-NL60SWG4-A2	InGaN	White	Water Transparent

**Package Outline Dimensions -**

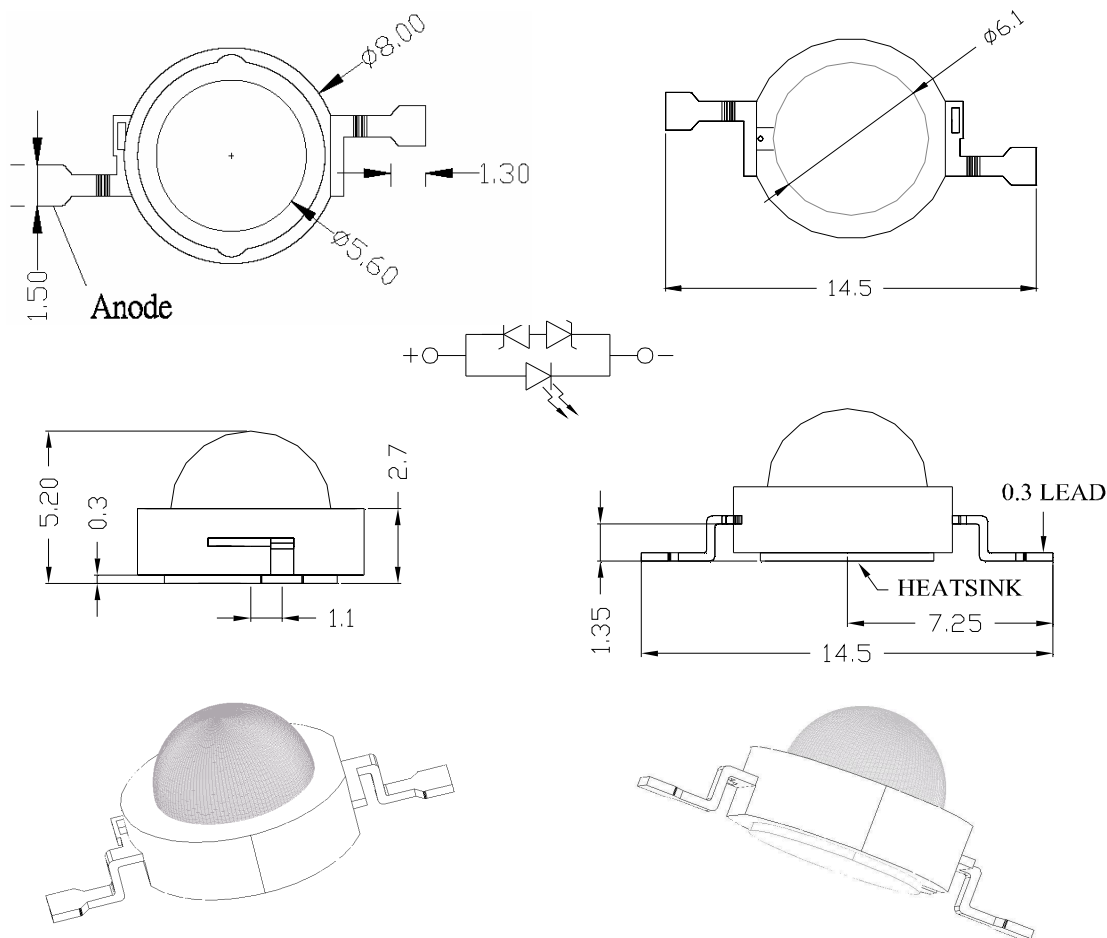

Notes: Tolerance of measurement of Dimension:  $\pm 0.25\text{mm}$



**Model No : CSHV-NL60SWG4-A2**

■ **Absolute Maximum Rating -**

(Ta=25°C)

Parameter	Symbol	Rating	Unit
Power Dissipation	<b>Pd</b>	2	W
Forward Current (DC)	<b>IF</b>	500	mA
Peak Forward Current *	<b>IFP</b>	750	mA
Reverse Voltage	<b>VR</b>	5	V
Operating Temp.	<b>Topr</b>	-40 ~ +85	°C
Storage Temp.	<b>Tstg</b>	-40 ~ +100	°C

\* Pulse width  $\leq$  0.1 msec. duty  $\leq$  1/10

■ **Electro-optical Characteristics -**

(Ta=25°C)

Parameter	Symbol	Min.	Typ.	Max.	Unit	Condition
Forward Voltage	<b>VF</b>	-----	3.4	4	V	IF=350mA
Luminous Flux	<b>Φv</b>	70	80	-----	lm	
Viewing Angle	<b>2θ 1/2</b>	-----	120	-----	deg	
Reverse Current	<b>IR</b>	-----	-----	50	μA	VR=5V



**Model No : CSHV-NL60SWG4-A2**

**■ Luminous Flux Rank Limits ( I<sub>f</sub> = 350mA )**

unit : lm

Part No.	CSHV-NL60SWG4-A2	
Code	min.	max.
L	70	80
M	80	90
N	90	100
P	100	120

**■ Color Rank Limits ( I<sub>f</sub> = 350mA )**

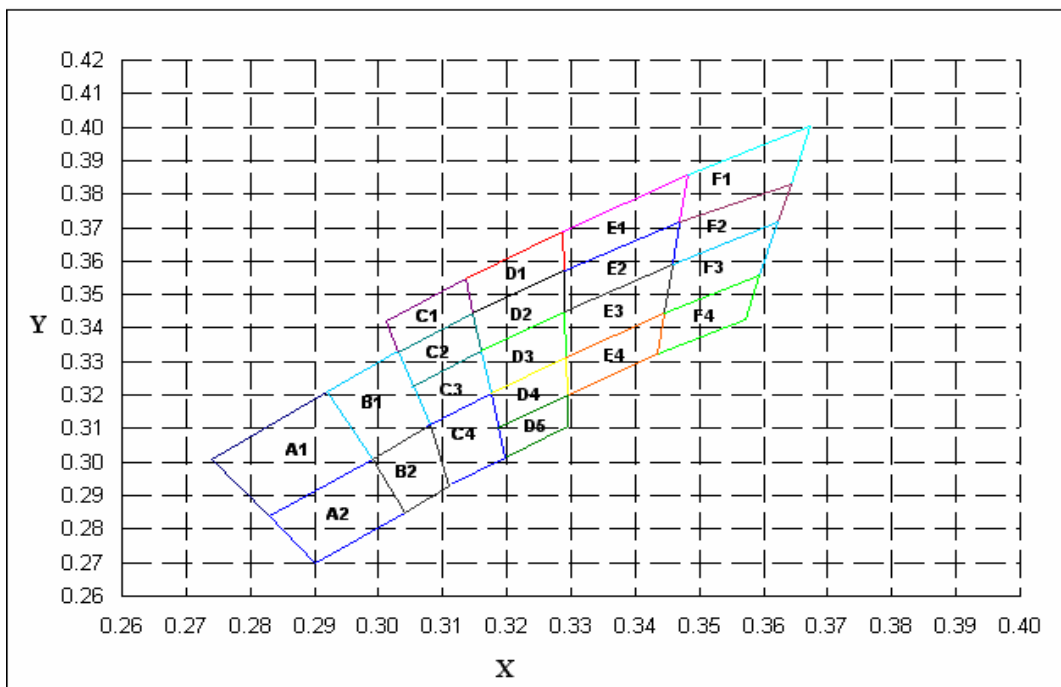

Rank A Color Temperature:8000~10000K									
A1					A2				
X	0.2920	0.2740	0.2830	0.2990	X	0.3040	0.2900	0.2830	0.2990
Y	0.3210	0.3010	0.2840	0.3010	Y	0.2850	0.2700	0.2840	0.3010

Rank B Color Temperature:6700~8000K									
B1					B2				
X	0.2990	0.2920	0.3030	0.3080	X	0.3040	0.2990	0.3080	0.3110
Y	0.3010	0.3210	0.3330	0.3110	Y	0.2850	0.3010	0.3110	0.2930

Rank C Color Temperature:6000~6700K									
C1					C3				
X	0.3011	0.3136	0.3148	0.3031	X	0.3052	0.3160	0.3175	0.3076
Y	0.3422	0.3550	0.3444	0.3327	Y	0.3224	0.3332	0.3204	0.3108
C2					C4				
X	0.3031	0.3148	0.3160	0.3052	X	0.3076	0.3175	0.3196	0.3112
Y	0.3327	0.3444	0.3332	0.3224	Y	0.3108	0.3204	0.3013	0.2932



**Model No : CSHV-NL60SWG4-A2**

**Color Rank Limits ( I<sub>F</sub> = 350mA )**

Rank D Color Temperature:5300~6000K									
<b>D1</b>					<b>D4</b>				
<b>X</b>	0.3136	0.3286	0.3288	0.3148	<b>X</b>	0.3175	0.3292	0.3294	0.3186
<b>Y</b>	0.3550	0.3690	0.3569	0.3444	<b>Y</b>	0.3204	0.3313	0.3202	0.3102
<b>D2</b>					<b>D5</b>				
<b>X</b>	0.3148	0.3288	0.3290	0.3160	<b>X</b>	0.3186	0.3294	0.3295	0.3196
<b>Y</b>	0.3444	0.3569	0.3451	0.3332	<b>Y</b>	0.3102	0.3202	0.3105	0.3013
<b>D3</b>									
<b>X</b>	0.3160	0.3290	0.3292	0.3175					
<b>Y</b>	0.3332	0.3451	0.3313	0.3204					

Rank E Color Temperature:4750~5300K									
<b>E1</b>					<b>E3</b>				
<b>X</b>	0.3286	0.3481	0.3469	0.3288	<b>X</b>	0.3290	0.3458	0.3444	0.3292
<b>Y</b>	0.3690	0.3856	0.3717	0.3569	<b>Y</b>	0.3451	0.3592	0.3442	0.3313
<b>E2</b>					<b>E4</b>				
<b>X</b>	0.3288	0.3469	0.3458	0.3290	<b>X</b>	0.3292	0.3444	0.3434	0.3294
<b>Y</b>	0.3569	0.3717	0.3592	0.3451	<b>Y</b>	0.3313	0.3442	0.3320	0.3202

Rank F Color Temperature:4300~4750K									
<b>F1</b>					<b>F3</b>				
<b>X</b>	0.3481	0.3673	0.3642	0.3469	<b>X</b>	0.3458	0.3622	0.3594	0.3444
<b>Y</b>	0.3856	0.4003	0.3829	0.3717	<b>Y</b>	0.3592	0.3716	0.3557	0.3442
<b>F2</b>					<b>F4</b>				
<b>X</b>	0.3469	0.3642	0.3622	0.3458	<b>X</b>	0.3444	0.3594	0.3571	0.3434
<b>Y</b>	0.3717	0.3829	0.3716	0.3592	<b>Y</b>	0.3442	0.3557	0.3426	0.3320

**Notes:**

1. Tolerance of measurement of luminous Flux ±10%
2. Tolerance of measurement of Color Coordinates ±0.01
3. All data are measured by CSC's test equipment.
4. Please confirm with CSC salesman,if your request different from standard specification.



Model No : CSHV-NL60SWG4-A2

■ Typical Electrical / Optical Characteristics Curves -

(Ta = 25°C Unless Otherwise Noted)

Fig 1. Relative Luminous FLux vs. Forward Current

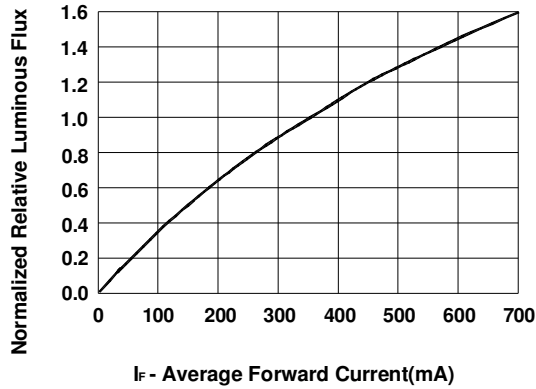

Fig 2. Forward Current vs. Forward Voltage

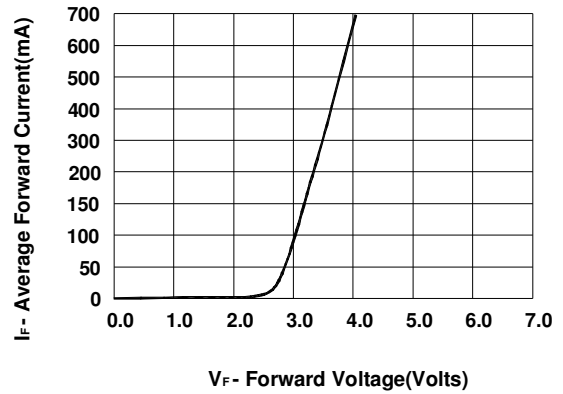

Fig 3. Maximum Forward Current vs. Ambient Temperature. Derating based on T<sub>JMAX</sub> = 120°C

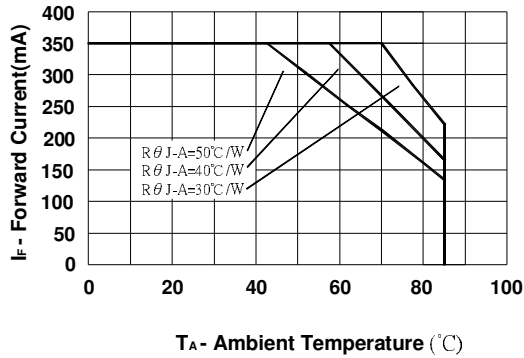

Fig 4. Relative Light Output vs. Junction Temperature

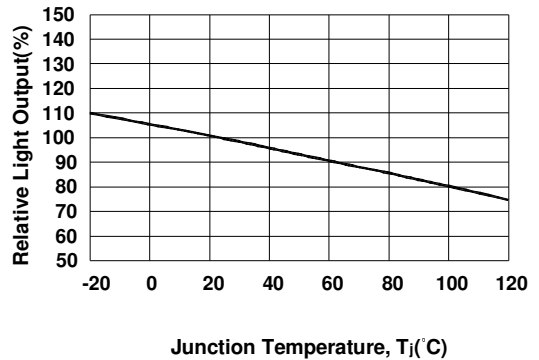

Fig 5. Relative Spectral Power Distribution vs. Wavelength

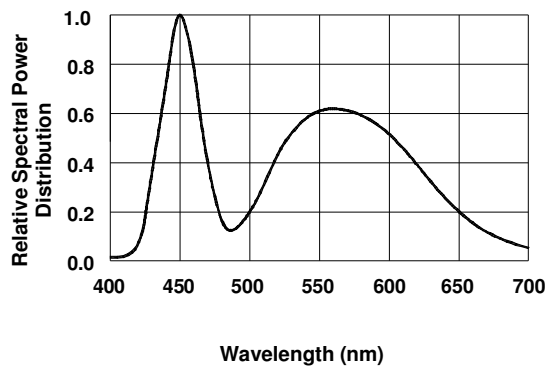
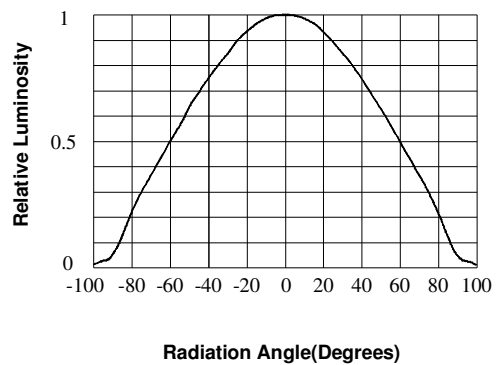

Fig 6. Relative Luminosity vs. Radiation Angle





**Model No : CSHV-NL60SWG4-A2**

**Reflow Soldering Characteristics**

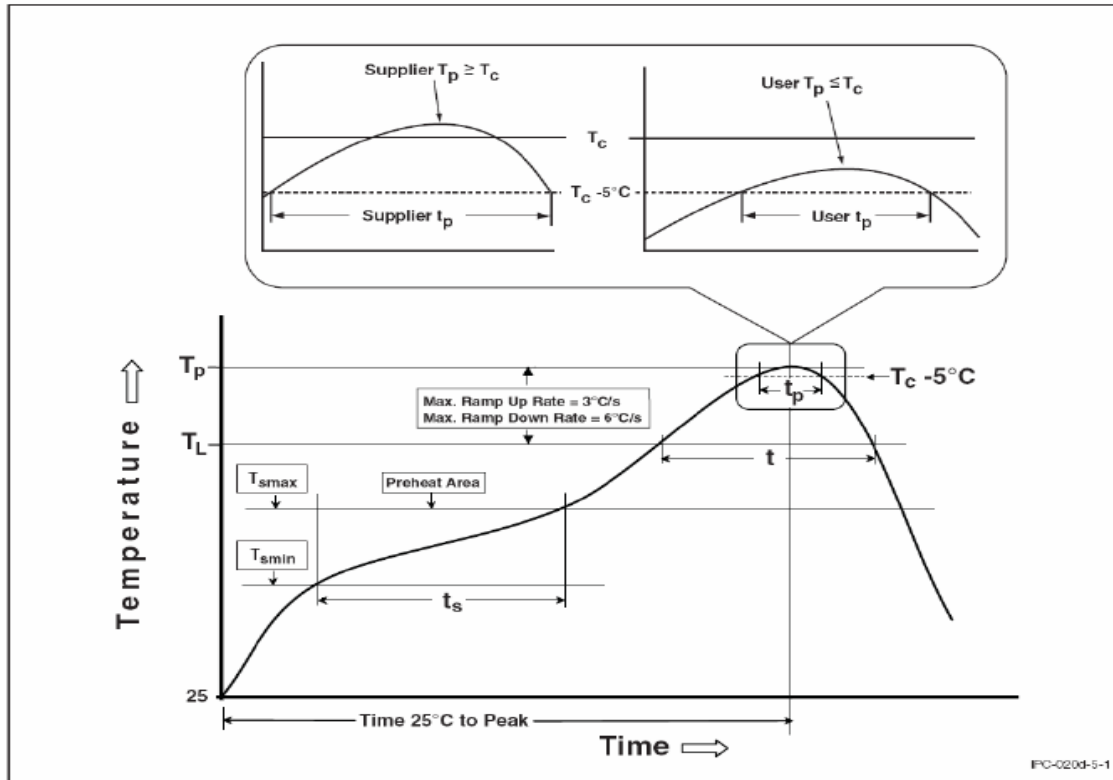

Profile Feature	Sn-Pb Eutectic Assembly	Pb-Free Assembly
<b>Preheat &amp; Soak</b>		
Temperature min ( $T_{smin}$ )	100 °C	150 °C
Temperature max ( $T_{smax}$ )	150 °C	200 °C
Time ( $T_{smin}$ to $T_{smax}$ ) ( $t_s$ )	60-120 seconds	60-120 seconds
Average ramp-up rate ( $T_{smax}$ to $T_p$ )	3 °C/second max.	3 °C/second max.
Liquidous temperature ( $T_L$ )	183 °C	217 °C
Time at liquidous ( $t_L$ )	60-150 seconds	60-150 seconds
Peak package body temperature ( $T_p$ )*	See classification temp in Table 4.1	See classification temp in Table 4.2
Time ( $t_p$ )** within 5 °C of the specified classification temperature ( $T_c$ )	20** seconds	30** seconds
Average ramp-down rate ( $T_p$ to $T_{smax}$ )	6 °C/second max.	6 °C/second max.
Time 25 °C to peak temperature	6 minutes max.	8 minutes max.

\* Tolerance for peak profile temperature ( $T_p$ ) is defined as a supplier minimum and a user maximum.  
 \*\* Tolerance for time at peak profile temperature ( $t_p$ ) is defined as a supplier minimum and a user maximum.

**Hand Soldering Characteristics**

Soldering temperature	260 °C
Soldering time	5 sec

Notes: All temperatures refer to Solder Pad



<b>Spec. No.</b>	PS-0701-007
<b>Rev.</b>	D

**Model No : CSHV-NL60SWG4-A2**

**Package**

1. Tube: 50pcs/tube

CSC P/N: CSC Production number

Flux: intensity grade

Hue: wavelength grade

Qty: quantity

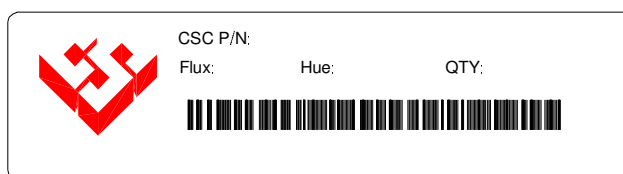
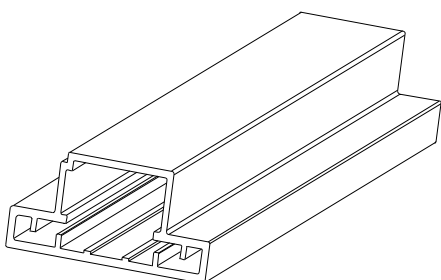

on tube

2. anti-electrostatic bag: 10 tubes/ bag

Product type: Vega Power

CSC P/N: CSC Production number

Flux: intensity grade

Hue: wavelength grade

Date code: production time

Customer P/N: customer production number

Qty: quantity

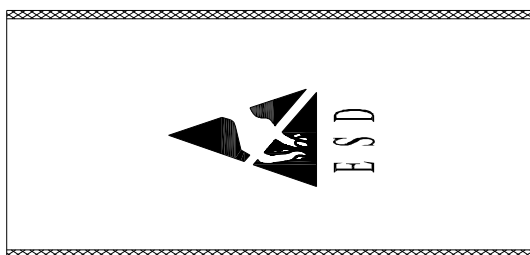

on anti-electrostatic bag

3. carton: 2 anti-electrostatic bags/carton

P/N: production number

Qty: quantity

Date code: production time

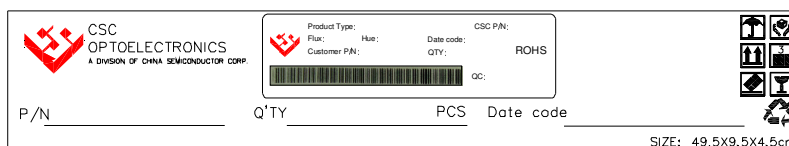
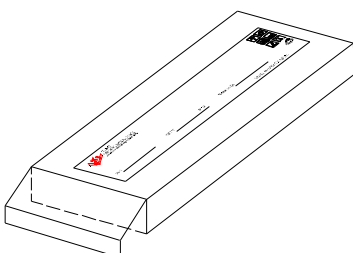

on carton





**Model No : CSHV-NL60SWG4-A2**

**■ Precautions for use**

1. Please use LEDES refer to JEDEC 2a(Industry Best Moisture Sensitivity Level) as below:

Floor life		standard		accelerated Environment	
time	conditions	time	conditions	time	conditions
4	≤ 30°C/60%RH	(hours)	30°C/60%RH	(hours)	60°C/60%RH
weeks		696 <sup>2</sup> +5/-0		120+1/-0	

Notes: The standard soak time includes a default value of 24 hours for semiconductor exposure time between bake and bag and includes the maximum time allowed out of bag at the distributor's facility.

2. Please confirm the moisture card in the anti-electrostatic bag after opening package.

If it shows 50%RH, LEDs should be performed baking treatment before used.

(bake condition: At 125°C +5/-0 for 24 hours)

3. Any mechanical force or any excess vibration on LENS should be avoided during operating.

4. LED should be stored below 60%RH after opening package.

5. Please refer to fig3 of page4 to choose current drive to use. Ambient temperature will affect current.

Note: The specifications are subject to change without notice. Please contact us for updated information.