

RoHS Compliant Product
A suffix of "-C" specifies halogen & lead-free

DESCRIPTION

The SSG9435 provide the designer with the best combination of fast switching, ruggedized device design, low on-resistance and cost-effectiveness. The SOP-8 package is universally preferred for all commercial-industrial surface mount applications and suited for low voltage applications such as DC/DC converters.

FEATURES

- Simple Drive Requirement
- Lower On-resistance
- Fast Switching Performance

PACKAGE DIMENSIONS

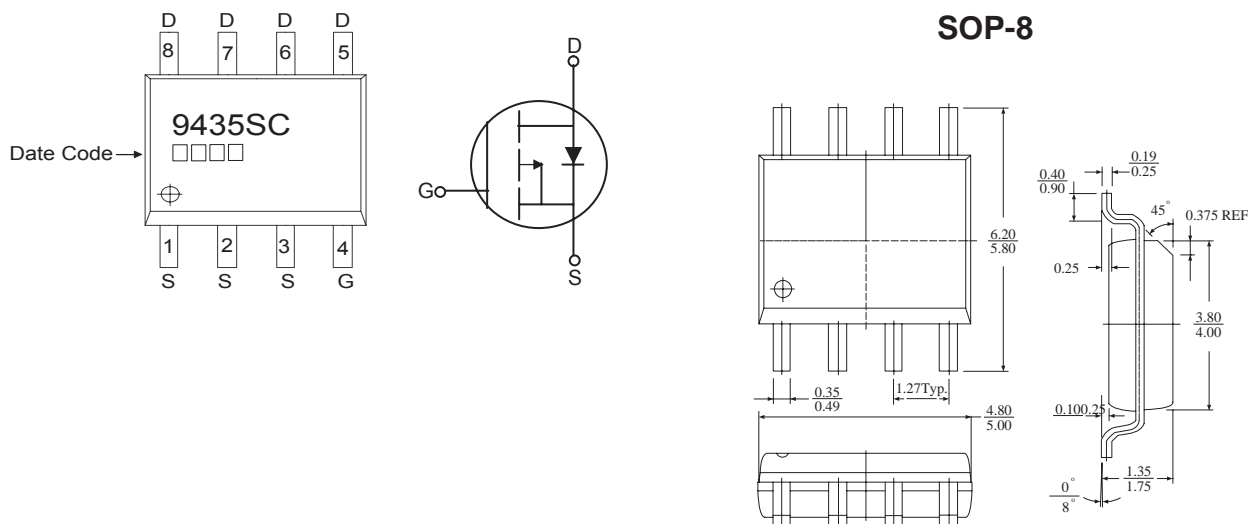

ABSOLUTE MAXIMUM RATINGS

Parameter	Symbol	P-ch Ratings	Unit
Drain-Source Voltage	V_{DS}	-30	V
Gate-Source Voltage	V_{GS}	± 16	V
Continuous Drain Current ³ , $V_{GS}@ 10V$	$I_D @ Ta=25^\circ C$	-5.3	A
Continuous Drain Current ³ , $V_{GS}@ 10V$	$I_D @ Ta=70^\circ C$	-4.7	A
Pulsed Drain Current ¹ ,	I_{DM}	-20	A
Total Power Dissipation	$P_D @ Ta=25^\circ C$	2.5	W
Operating Junction and Storage Temperature Range	T_j, T_{stg}	-55 ~ +150	$^\circ C$
Linear Derating Factor		0.02	W/ $^\circ C$

THERMAL DATA

Parameter	Symbol	Value	Unit
Thermal Resistance Junction-ambient Max.	$R_{\theta j-amb}$	50	$^\circ C / W$

P-CHANNEL ELECTRICAL CHARACTERISTICS (T_j = 25°C unless otherwise specified)

Parameter	Symbol	Min.	Typ.	Max.	Unit	Test Conditions
Drain-Source Breakdown Voltage	BV _{DSS}	-30	-	-	V	V _{GS} =0, I _D =-250μA
Breakdown Voltage Temp. Coefficient	ΔBV _{DSS} /ΔT _J	-	-0.037	-	V/°C	Reference to 25°C, I _D =-1mA
Gate Threshold Voltage	V _{GS(th)}	-1.0	-	-3.0	V	V _{DS} =V _{GS} , I _D =-250μA
Forward Transconductance	g _{fs}	-	10	-	S	V _{DS} =-10V, I _D =-5.3A
Gate-Source Leakage Current	I _{GSS}	-	-	±100	nA	V _{GS} = ±16V
Drain-Source Leakage Current(T _J =25°C)	I _{DSS}	-	-	-1	μA	V _{DS} =-30V, V _{GS} =0
Drain-Source Leakage Current(T _J =70°C)		-	-	-5	μA	V _{DS} =-24V, V _{GS} =0
Static Drain-Source On-Resistance	R _{DS(ON)}	-	-	55	mΩ	V _{GS} =-10V, I _D =-5.3A
		-	-	90		V _{GS} =-4.5 V, I _D =-4.2 A
Total Gate Charge ²	Q _g	-	28	-	nC	I _D =-5.3 A V _{DS} =-15 V V _{GS} =-10 V
Gate-Source Charge	Q _{gs}	-	3	-		
Gate-Drain ("Miller") Charge	Q _{gd}	-	7	-		
Turn-on Delay Time ²	T _{d(on)}	-	9	-	ns	V _{DS} =-15 V I _D =-1 A V _{GS} =-10 V R _G =6 Ω R _D =15 Ω
Rise Time	T _r	-	15	-		
Turn-off Delay Time	T _{d(off)}	-	75	-		
Fall Time	T _f	-	40	-		
Input Capacitance	C _{iss}	-	745	-	pF	V _{GS} =0 V V _{DS} =-15 V f=1.0 MHz
Output Capacitance	C _{oss}	-	440	-		
Reverse Transfer Capacitance	C _{rss}	-	120	-		

SOURCE-DRAIN DIODE

Parameter	Symbol	Min.	Typ.	Max.	Unit	Test Conditions
Forward On Voltage ²	V _{SD}	-	-0.75	-1.2	V	I _S =-2.6A, V _{GS} =0 V, T _J =25°C
Continuous Source Current (Body Diode)	I _S	-	-	-2.6	A	V _D = V _G = 0V,
Pulsed Source Current (Body Diode) ¹	I _{SM}	-	-	-20	A	V _S = -1.2 V

Notes: 1. Pulse width limited by Max. junction temperature.
2. Pulse width ≤ 300μs, duty cycle ≤ 2%.

CHARACTERISTIC CURVE

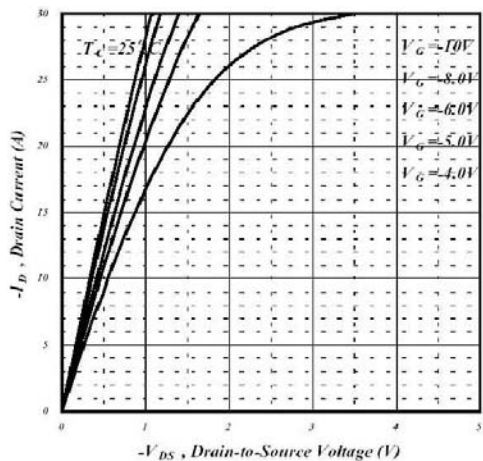

Fig 1. Typical Output Characteristics

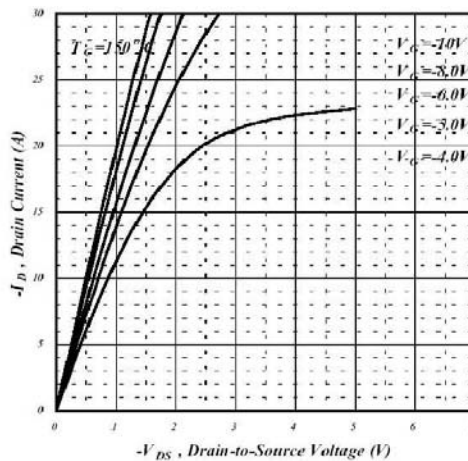

Fig 2. Typical Output Characteristics

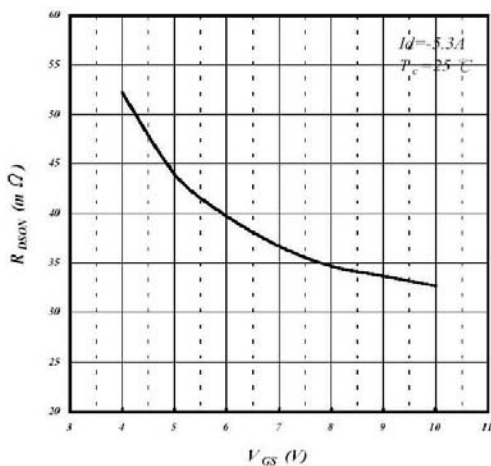

Fig 3. On-Resistance v.s. Gate Voltage

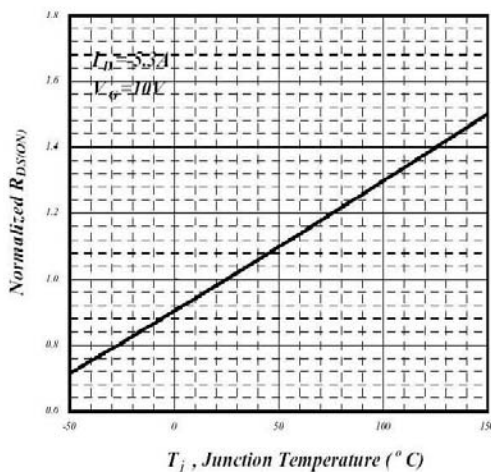

Fig 4. Normalized On-Resistance v.s. Junction Temperature

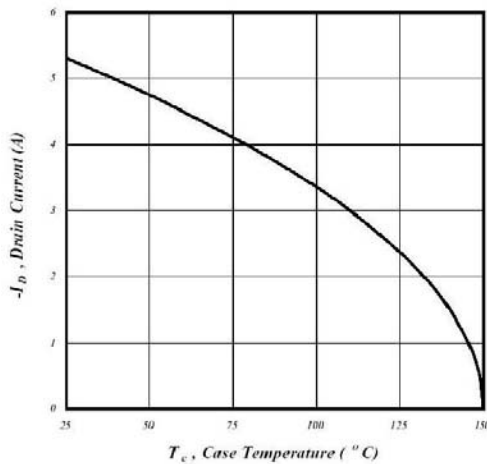

Fig 5. Maximum Drain Current v.s. Case Temperature

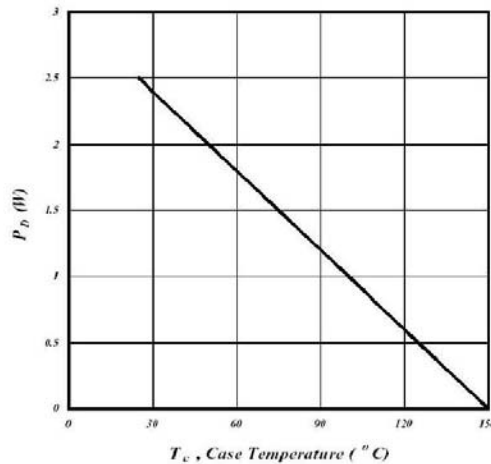

Fig 6. Type Power Dissipation

CHARACTERISTIC CURVE (cont'd)

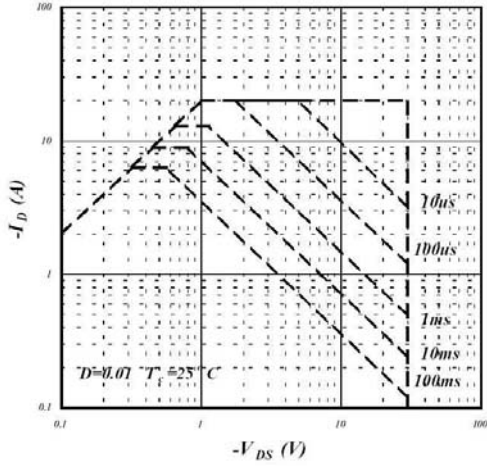

Fig 7. Maximum Safe Operating Area

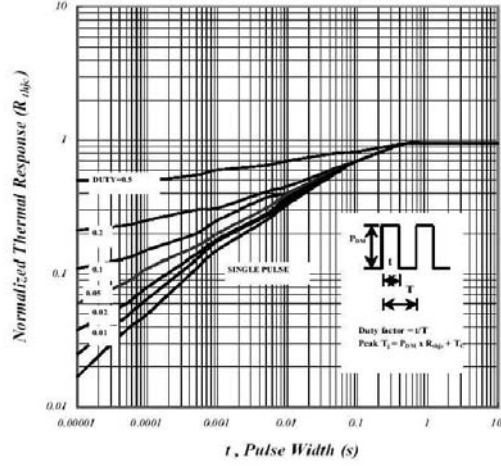

Fig 8. Effective Transient Thermal Impedance

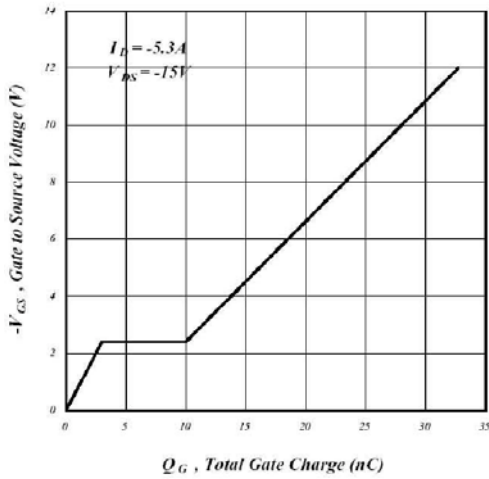

Fig 9. Gate Charge Characteristics

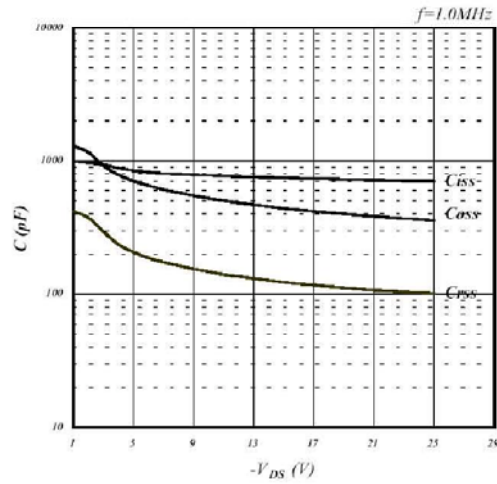

Fig 10. Typical Capacitance Characteristics

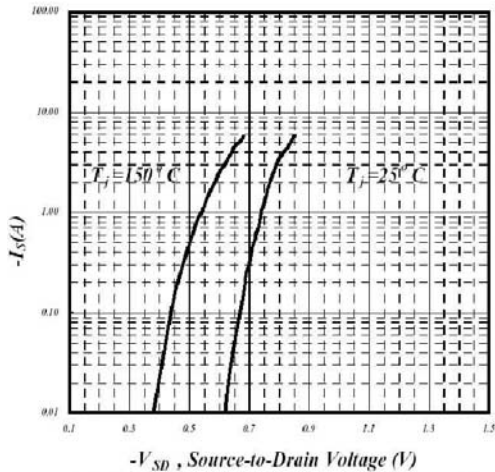

Fig 11. Forward Characteristics of Reverse Diode

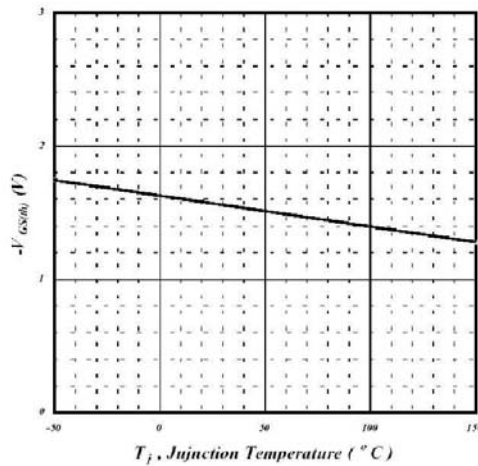

Fig 12. Gate Threshold Voltage v.s. Junction Temperature

CHARACTERISTIC CURVE (cont'd)

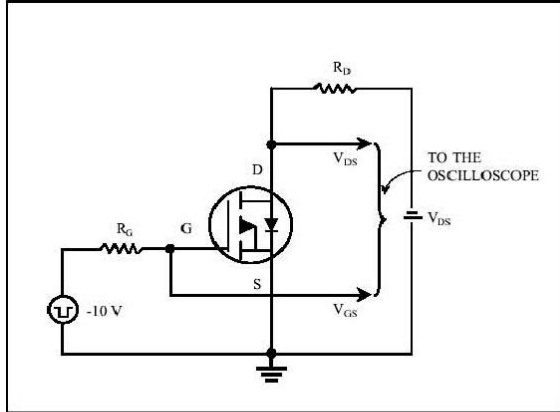

Fig 13. Switching Time Circuit

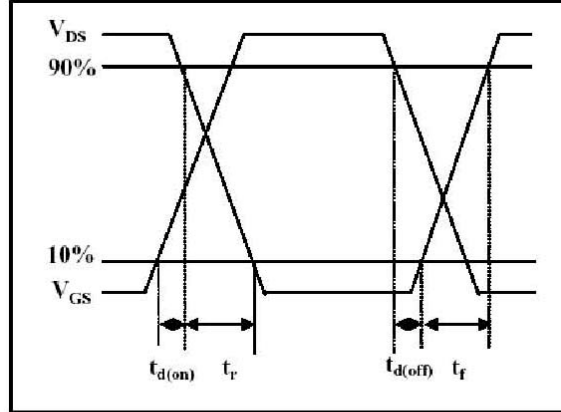

Fig 14. Switching Time Waveform

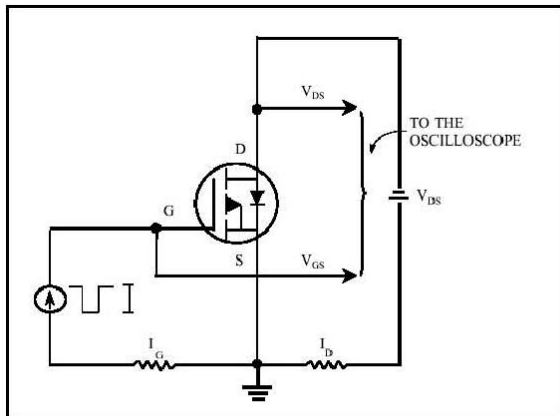

Fig 15. Gate Charge Circuit

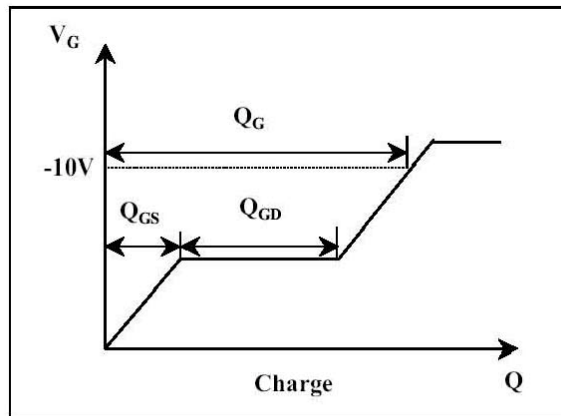

Fig 16. Gate Charge Waveform