



# RF Power Field Effect Transistors

## N-Channel Enhancement-Mode Lateral MOSFETs

Designed for CDMA base station applications with frequencies from 1470 to 1510 MHz. Suitable for TDMA, CDMA and multicarrier amplifier applications. To be used in Class AB and Class C for PCN-PCS/cellular radio and WLL applications.

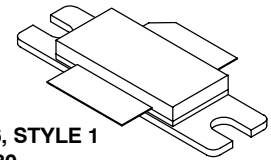
- Typical Single-Carrier W-CDMA Performance:  $V_{DD} = 28$  Volts,  $I_{DQ} = 600$  mA,  $P_{out} = 23$  Watts Avg.,  $f = 1507.5$  MHz, 3GPP Test Model 1, 64 DPCH with 50% Clipping, Channel Bandwidth = 3.84 MHz, Input Signal PAR = 7.5 dB @ 0.01% Probability on CCDF.  
 Power Gain — 19.5 dB  
 Drain Efficiency — 32%  
 Device Output Signal PAR — 6.2 dB @ 0.01% Probability on CCDF  
 ACPR @ 5 MHz Offset — -38 dBc in 3.84 MHz Channel Bandwidth
- Capable of Handling 10:1 VSWR, @ 32 Vdc, 1490 MHz, 100 Watts CW Output Power
- Typical  $P_{out}$  @ 1 dB Compression Point  $\approx 100$  Watts CW

### Features

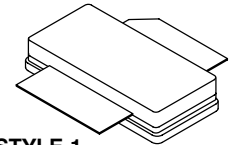
- 100% PAR Tested for Guaranteed Output Power Capability
- Characterized with Series Equivalent Large-Signal Impedance Parameters
- Internally Matched for Ease of Use
- Integrated ESD Protection
- Greater Negative Gate-Source Voltage Range for Improved Class C Operation
- Optimized for Doherty Applications
- RoHS Compliant
- In Tape and Reel. R3 Suffix = 250 Units per 56 mm, 13 inch Reel.

**MRF7S15100HR3**  
**MRF7S15100HSR3**

**1510 MHz, 23 W AVG., 28 V**  
**SINGLE W-CDMA**  
**LATERAL N-CHANNEL**  
**RF POWER MOSFETs**



**CASE 465-06, STYLE 1**  
**NI-780**  
**MRF7S1500HR3**



**CASE 465A-06, STYLE 1**  
**NI-780S**  
**MRF7S1500HSR3**

**Table 1. Maximum Ratings**

Rating	Symbol	Value	Unit
Drain-Source Voltage	$V_{DSS}$	-0.5, +65	Vdc
Gate-Source Voltage	$V_{GS}$	-6.0, +10	Vdc
Operating Voltage	$V_{DD}$	32, +0	Vdc
Storage Temperature Range	$T_{stg}$	- 65 to +150	°C
Case Operating Temperature	$T_C$	150	°C
Operating Junction Temperature <sup>(1)</sup>	$T_J$	225	°C

**Table 2. Thermal Characteristics**

Characteristic	Symbol	Value <sup>(2)</sup>	Unit
Thermal Resistance, Junction to Case	$R_{\theta JC}$		°C/W
Case Temperature 80°C, 55 W CW		0.65	
Case Temperature 77°C, 23 W CW		0.74	

1. Continuous use at maximum temperature will affect MTF.
2. Refer to AN1955, *Thermal Measurement Methodology of RF Power Amplifiers*. Go to <http://www.freescale.com/rf>. Select Documentation/Application Notes - AN1955.

**Table 3. ESD Protection Characteristics**

Test Methodology	Class
Human Body Model (per JESD22-A114)	IC (Minimum)
Machine Model (per EIA/JESD22-A115)	A (Minimum)
Charge Device Model (per JESD22-C101)	IV (Minimum)

**Table 4. Electrical Characteristics** ( $T_C = 25^\circ\text{C}$  unless otherwise noted)

Characteristic	Symbol	Min	Typ	Max	Unit
----------------	--------	-----	-----	-----	------

**Off Characteristics**

Zero Gate Voltage Drain Leakage Current ( $V_{DS} = 65\text{ Vdc}$ , $V_{GS} = 0\text{ Vdc}$ )	$I_{DSS}$	—	—	10	$\mu\text{Adc}$
Zero Gate Voltage Drain Leakage Current ( $V_{DD} = 28\text{ Vdc}$ , $V_{GS} = 0\text{ Vdc}$ )	$I_{DSS}$	—	—	1	$\mu\text{Adc}$
Gate-Source Leakage Current ( $V_{GS} = 5\text{ Vdc}$ , $V_{DS} = 0\text{ Vdc}$ )	$I_{GSS}$	—	—	1	$\mu\text{Adc}$

**On Characteristics**

Gate Threshold Voltage ( $V_{DS} = 10\text{ Vdc}$ , $I_D = 174\ \mu\text{Adc}$ )	$V_{GS(th)}$	1.2	2	2.7	Vdc
Gate Quiescent Voltage ( $V_{DD} = 28\text{ Vdc}$ , $I_D = 600\text{ mAdc}$ , Measured in Functional Test)	$V_{GS(Q)}$	2	2.7	3.5	Vdc
Drain-Source On-Voltage ( $V_{GS} = 10\text{ Vdc}$ , $I_D = 1.74\text{ Adc}$ )	$V_{DS(on)}$	0.1	0.2	0.3	Vdc

**Dynamic Characteristics (1)**

Reverse Transfer Capacitance ( $V_{DS} = 28\text{ Vdc} \pm 30\text{ mV(rms)ac}$ @ 1 MHz, $V_{GS} = 0\text{ Vdc}$ )	$C_{rss}$	—	0.6	—	pF
Output Capacitance ( $V_{DS} = 28\text{ Vdc} \pm 30\text{ mV(rms)ac}$ @ 1 MHz, $V_{GS} = 0\text{ Vdc}$ )	$C_{oss}$	—	300	—	pF
Input Capacitance ( $V_{DS} = 28\text{ Vdc}$ , $V_{GS} = 0\text{ Vdc} \pm 30\text{ mV(rms)ac}$ @ 1 MHz)	$C_{iss}$	—	176	—	pF

**Functional Tests** (In Freescale Test Fixture, 50 ohm system)  $V_{DD} = 28\text{ Vdc}$ ,  $I_{DQ} = 600\text{ mA}$ ,  $P_{out} = 23\text{ W Avg.}$ ,  $f = 1507.5\text{ MHz}$ , Single-Carrier W-CDMA, 3GPP Test Model 1, 64 DPCH, 50% Clipping, Input Signal PAR = 7.5 dB @ 0.01% Probability on CCDF. ACPR measured in 3.84 MHz Channel Bandwidth @  $\pm 5\text{ MHz}$  Offset.

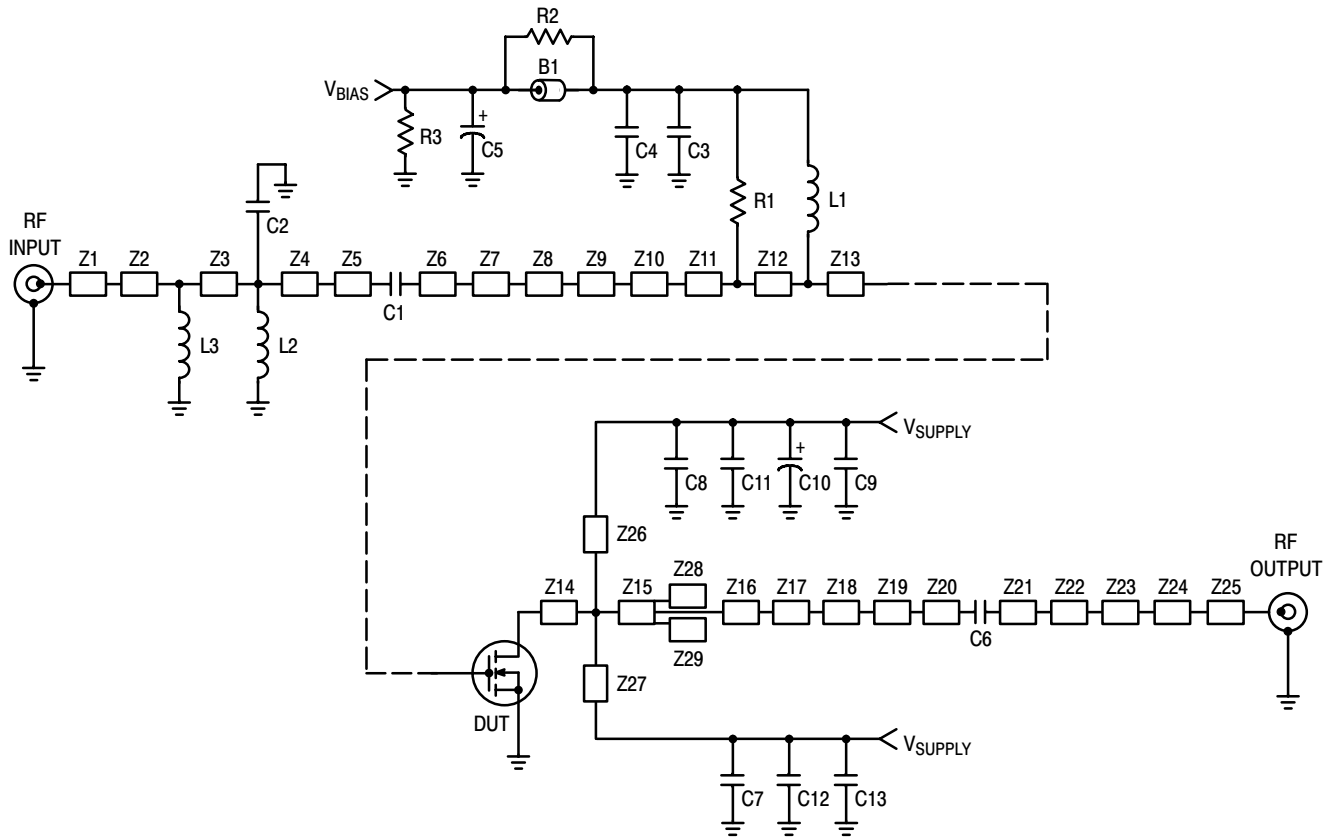
Power Gain	$G_{ps}$	18	19.5	21	dB
Drain Efficiency	$\eta_D$	30	32	—	%
Output Peak-to-Average Ratio @ 0.01% Probability on CCDF	PAR	5.9	6.2	—	dB
Adjacent Channel Power Ratio	ACPR	—	-38	-35	dBc
Input Return Loss	IRL	—	-15	-8	dB

1. Part internally matched both on input and output.

(continued)

**Table 4. Electrical Characteristics** ( $T_C = 25^\circ\text{C}$  unless otherwise noted) (continued)

Characteristic	Symbol	Min	Typ	Max	Unit
<b>Typical Performances</b> (In Freescale Test Fixture, 50 ohm system) $V_{DD} = 28\text{ Vdc}$ , $I_{DQ} = 600\text{ mA}$ , 1470-1510 MHz Bandwidth					
$P_{out}$ @ 1 dB Compression Point, CW	P1dB	—	100	—	W
IMD Symmetry @ 90 W PEP, $P_{out}$ where IMD Third Order Intermodulation $\cong 30\text{ dBc}$ (Delta IMD Third Order Intermodulation between Upper and Lower Sidebands > 2 dB)	IMD <sub>sym</sub>	—	40	—	MHz
VBW Resonance Point (IMD Third Order Intermodulation Inflection Point)	VBW <sub>res</sub>	—	70	—	MHz
Gain Flatness in 40 MHz Bandwidth @ $P_{out} = 23\text{ W Avg.}$	G <sub>F</sub>	—	0.2	—	dB
Average Deviation from Linear Phase in 40 MHz Bandwidth @ $P_{out} = 100\text{ W CW}$	$\Phi$	—	4.5	—	°
Average Group Delay @ $P_{out} = 100\text{ W CW}$ , $f = 1490\text{ MHz}$	Delay	—	1.9	—	ns
Part-to-Part Insertion Phase Variation @ $P_{out} = 100\text{ W CW}$ , $f = 1490\text{ MHz}$ , Six Sigma Window	$\Delta\Phi$	—	23	—	°
Gain Variation over Temperature (-30°C to +85°C)	$\Delta G$	—	0.010	—	dB/°C
Output Power Variation over Temperature (-30°C to +85°C)	$\Delta P_{1dB}$	—	0.007	—	W/°C



Z1	0.084" x 0.078" Microstrip	Z15	1.330" x 0.538" Microstrip
Z2	0.149" x 0.153" Microstrip	Z16	0.270" x 0.280" Microstrip
Z3	0.149" x 0.303" Microstrip	Z17	0.187" x 0.150" Microstrip
Z4	0.149" x 0.065" Microstrip	Z18	0.084" x 0.042" Microstrip
Z5	0.084" x 0.146" Microstrip	Z19	0.184" x 0.292" Microstrip
Z6	0.084" x 0.104" Microstrip	Z20	0.084" x 0.066" Microstrip
Z7	0.218" x 0.080" Microstrip	Z21	0.886" x 0.194" Microstrip
Z8	0.084" x 0.206" Microstrip	Z22	0.300" x 0.084" Microstrip
Z9	0.224" x 0.085" Microstrip	Z23	0.084" x 0.215" Microstrip
Z10	0.084" x 0.369" Microstrip	Z24	0.221" x 0.075" Microstrip
Z11	1.288" x 0.206" Microstrip	Z25	0.084" x 0.175" Microstrip
Z12	1.288" x 0.144" Microstrip	Z26, Z27	0.200" x 0.525" Microstrip
Z13	1.288" x 0.369" Microstrip	Z28, Z29	0.235" x 0.102" Microstrip
Z14	1.330" x 0.112" Microstrip	PCB	Arlon CuClad 250GX-0300-55-22, 0.030", $\epsilon_r = 2.55$

Figure 1. MRF7S15100HR3(HSR3) Test Circuit Schematic

Table 5. MRF7S15100HR3(HSR3) Test Circuit Component Designations and Values

Part	Description	Part Number	Manufacturer
B1	Short Ferrite Bead	2743019447	Fair-Rite
C1, C6, C7, C8	15 pF Chip Capacitors	ATC100B150JT500XT	ATC
C2	0.5 pF Chip Capacitor	ATC100B0R5BT500XT	ATC
C3	10 pF Chip Capacitor	ATC100B100JT500XT	ATC
C4, C9, C13	6.8 $\mu$ F, 50 V Chip Capacitors	C4532JB1H685MT	TDK
C5, C10	100 $\mu$ F, 50 V Electrolytic Capacitors	222215371101	Vishay
C11, C12	2.2 $\mu$ F, 50 V Chip Capacitors	C3225JB2A225MT	TDK
L1, L2, L3	7.15 nH Inductors	1606-TLC	Coilcraft
R1, R2	100 $\Omega$ , 1/4 W Chip Resistors	CRCW12061000FKEA	Vishay
R3	10 K $\Omega$ , 1/4 W Chip Resistor	CRCW12061002FKEA	Vishay

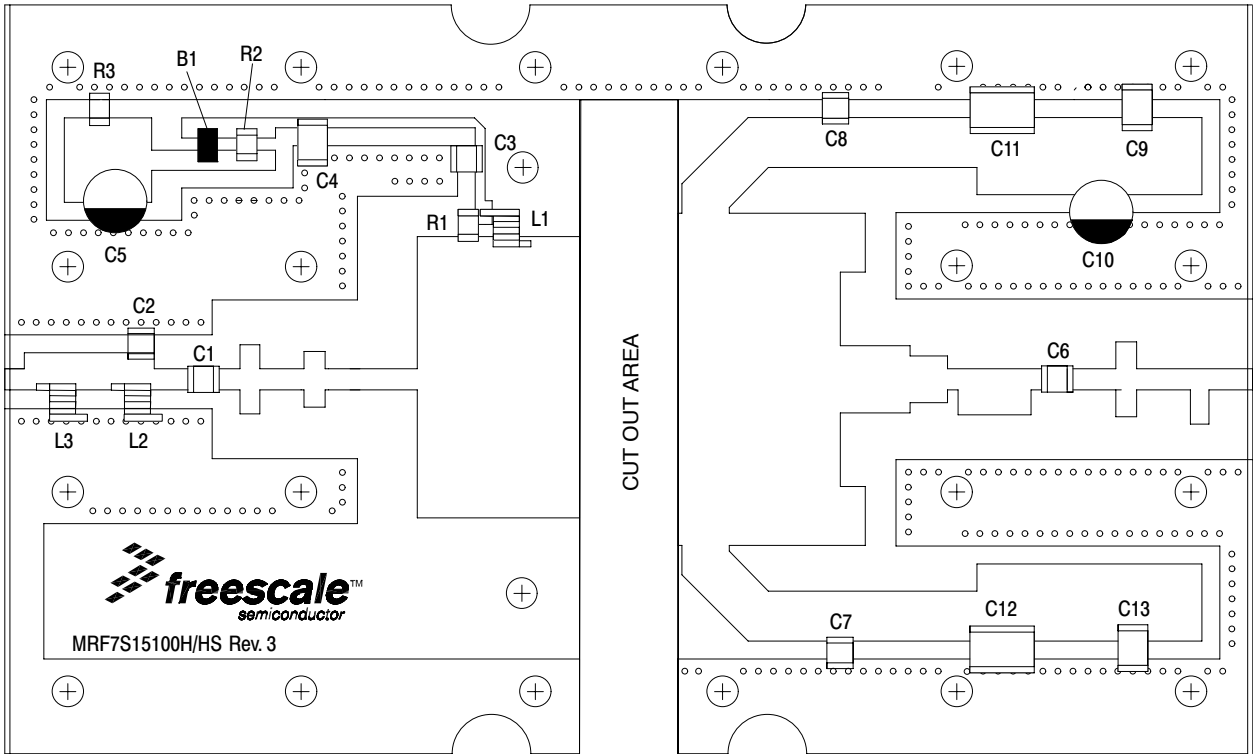
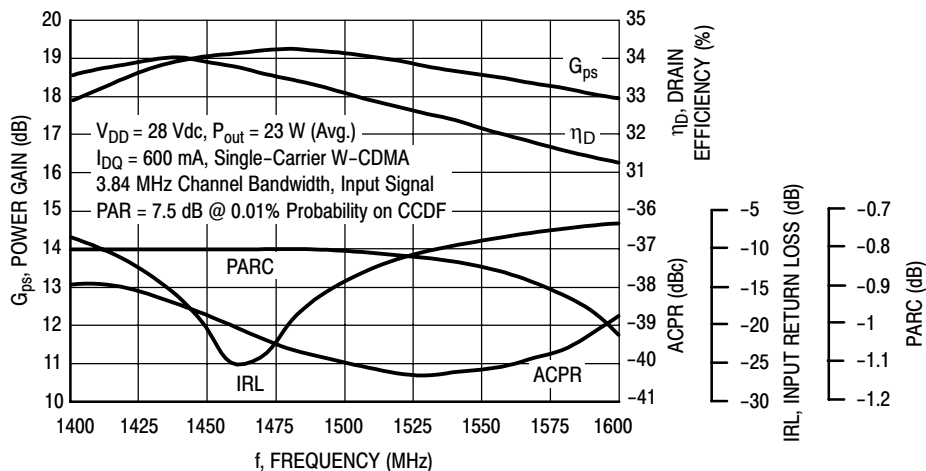
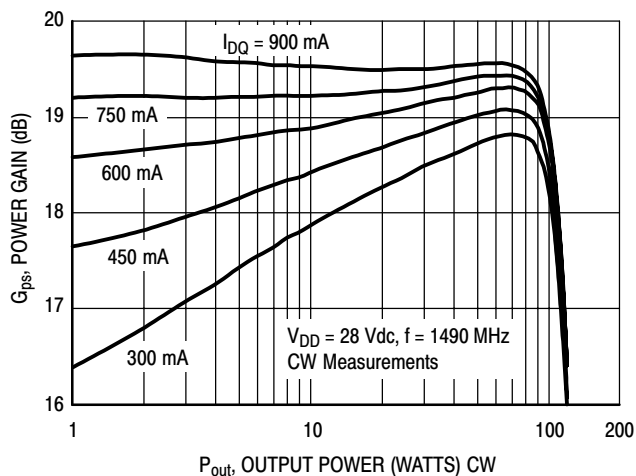


Figure 2. MRF7S15100HR3(HSR3) Test Circuit Component Layout

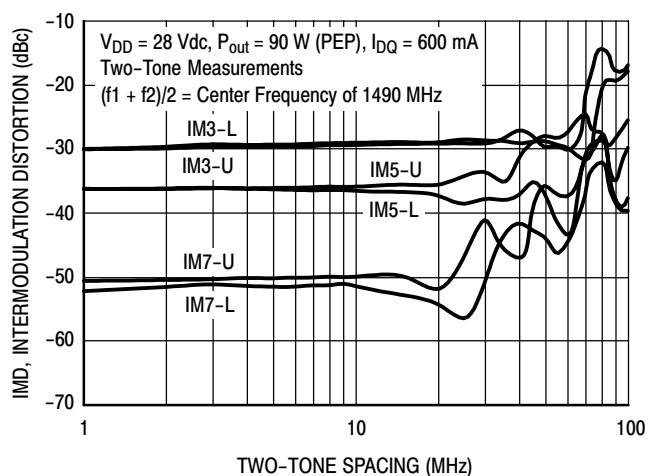
## TYPICAL CHARACTERISTICS



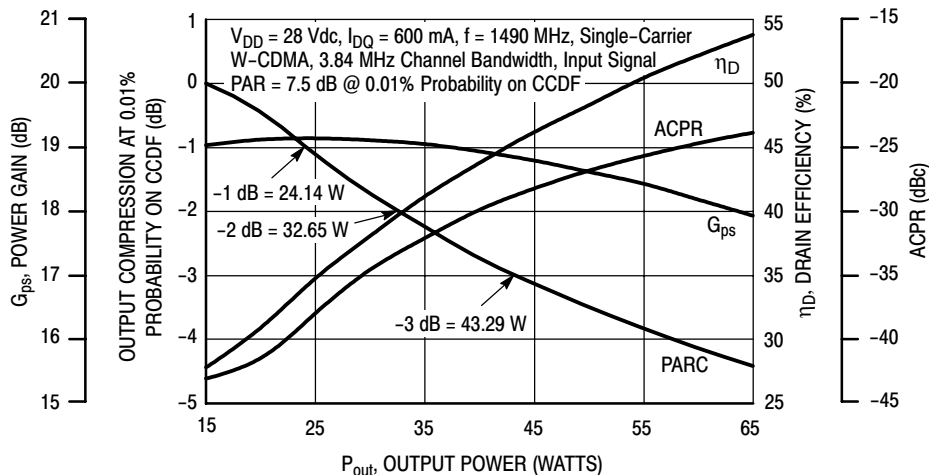
**Figure 3. Output Peak-to-Average Ratio Compression (PARC) Broadband Performance @  $P_{out} = 23$  Watts Avg.**



**Figure 4. CW Power Gain versus Output Power**

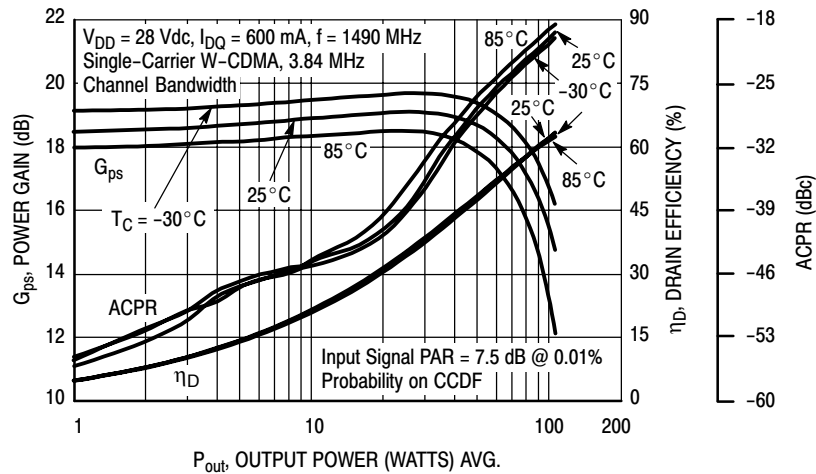


**Figure 5. Intermodulation Distortion Products versus Tone Spacing**

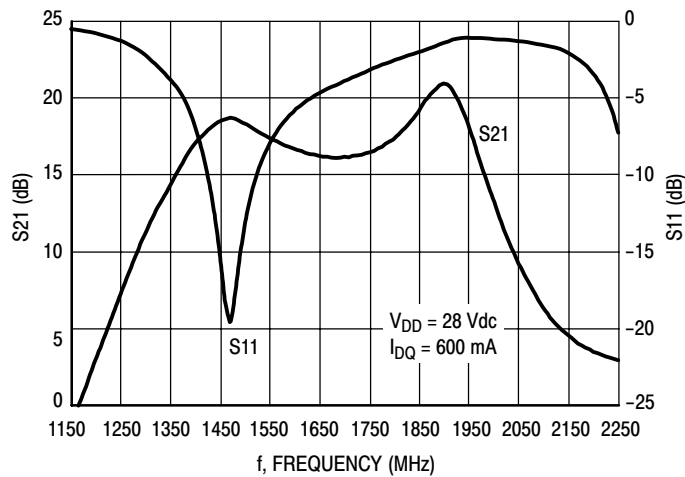


**Figure 6. Output Peak-to-Average Ratio Compression (PARC) versus Output Power**

## TYPICAL CHARACTERISTICS

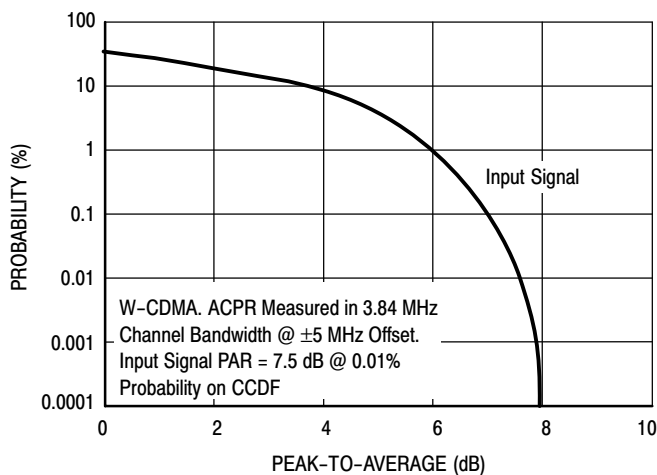


**Figure 7. Single-Carrier W-CDMA Power Gain, Drain Efficiency and ACPR versus Output Power**

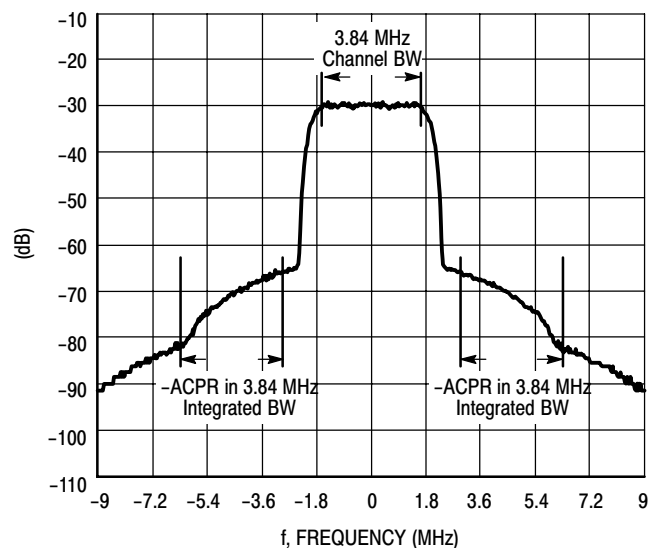


**Figure 8. Broadband Frequency Response**

## W-CDMA TEST SIGNAL

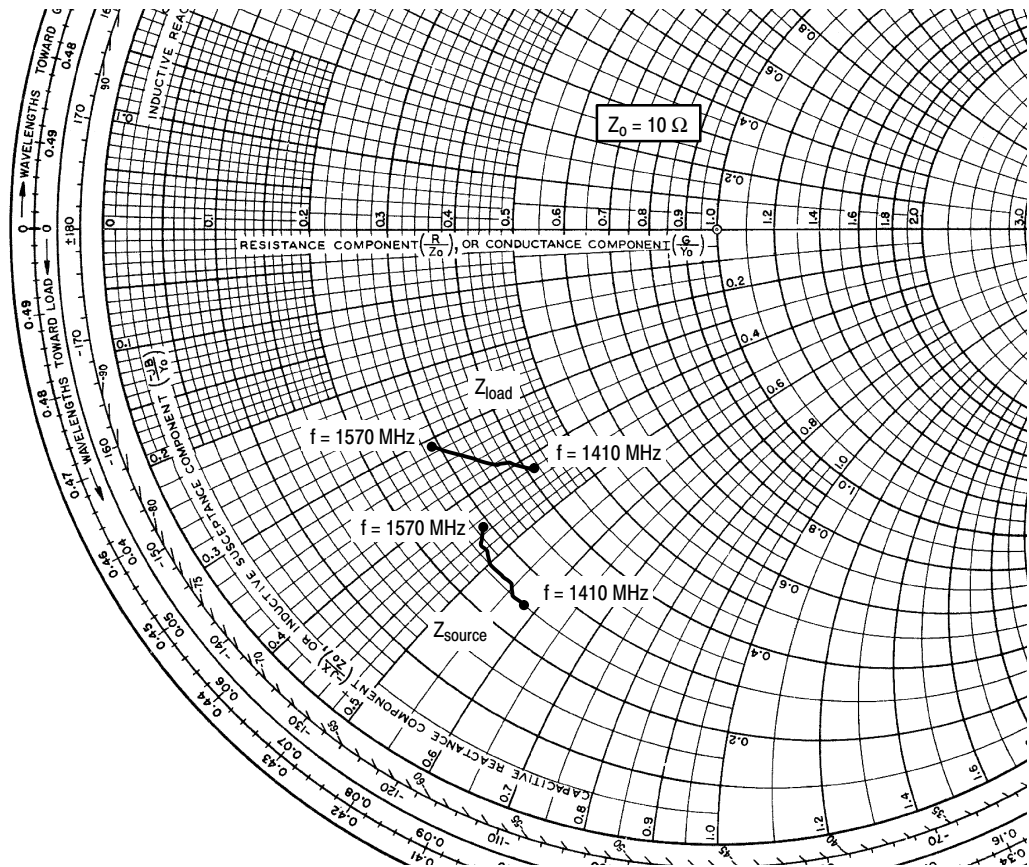


**Figure 9. CCDF W-CDMA 3GPP, Test Model 1, 64 DPCH, 50% Clipping, Single-Carrier Test Signal**



**Figure 10. Single-Carrier W-CDMA Spectrum**

MRF7S15100HR3 MRF7S15100HSR3



$V_{DD} = 28 \text{ Vdc}$ ,  $I_{DQ} = 600 \text{ mA}$ ,  $P_{out} = 23 \text{ W Avg.}$

f MHz	Z <sub>source</sub> Ω	Z <sub>load</sub> Ω
1410	2.51 - j5.82	4.12 - j4.20
1430	2.53 - j5.58	3.95 - j4.07
1450	2.55 - j5.36	3.78 - j3.94
1470	2.58 - j5.15	3.61 - j3.80
1490	2.62 - j4.97	3.45 - j3.65
1510	2.67 - j4.81	3.30 - j3.51
1530	2.73 - j4.68	3.15 - j3.37
1550	2.79 - j4.57	3.00 - j3.22
1570	2.85 - j4.49	2.87 - j3.06

Z<sub>source</sub> = Test circuit impedance as measured from gate to ground.

Z<sub>load</sub> = Test circuit impedance as measured from drain to ground.

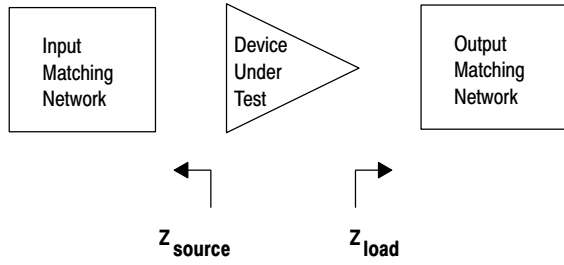
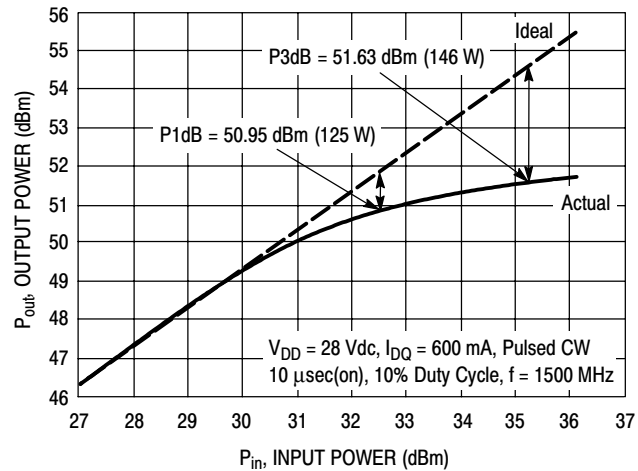


Figure 11. Series Equivalent Source and Load Impedance



## ALTERNATIVE PEAK TUNE LOAD PULL CHARACTERISTICS



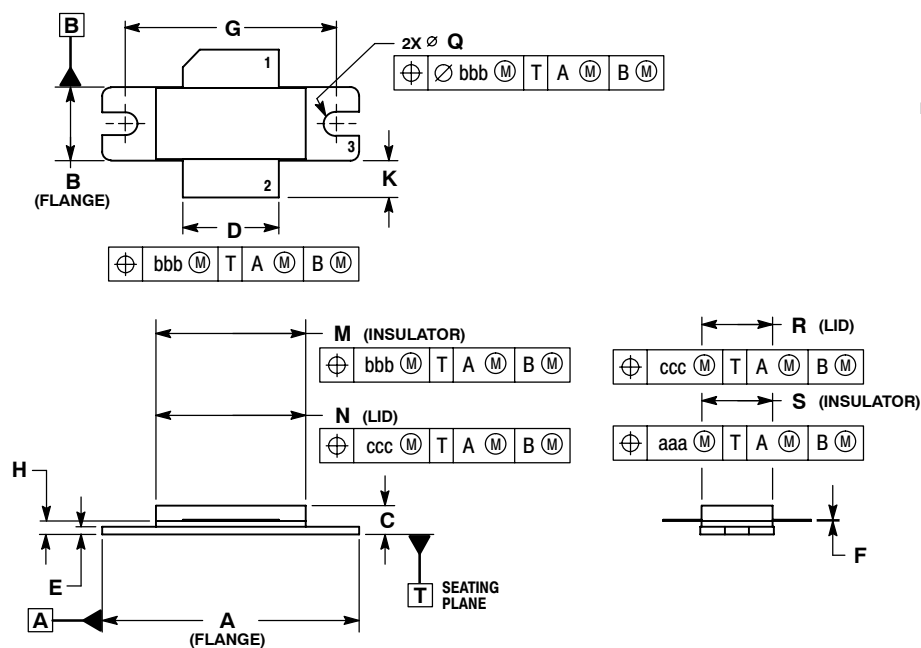
NOTE: Load Pull Test Fixture Tuned for Peak P1dB Output Power @ 28 V

Test Impedances per Compression Level

	$Z_{source}$ $\Omega$	$Z_{load}$ $\Omega$
P1dB	$2.02 + j6.21$	$2.00 - j3.65$

Figure 12. Pulsed CW Output Power versus Input Power @ 28 V

## PACKAGE DIMENSIONS

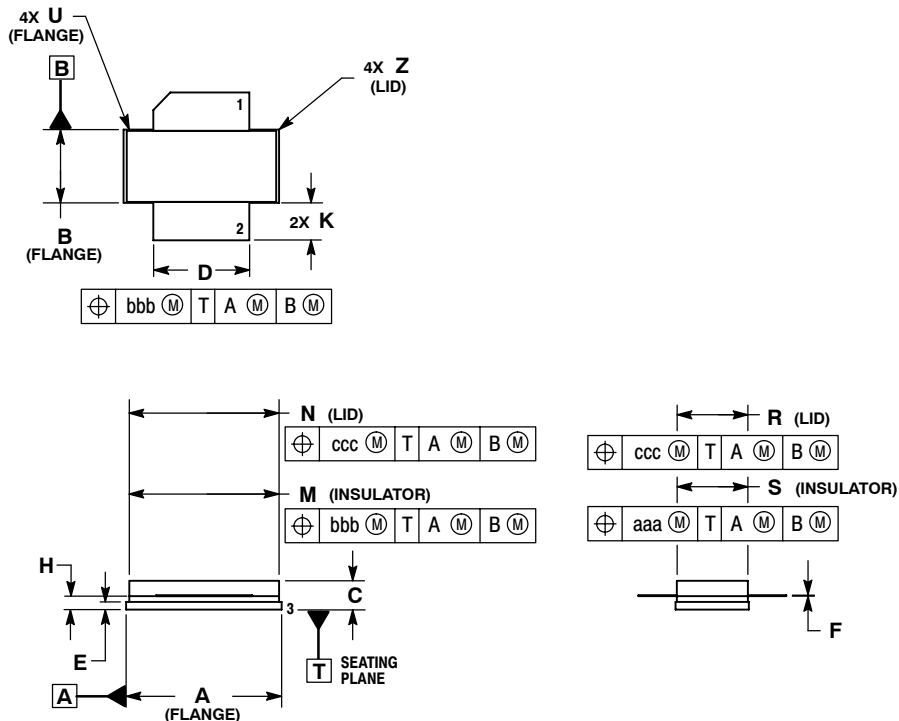


- NOTES:
1. DIMENSIONING AND TOLERANCING PER ANSI Y14.5M-1994.
  2. CONTROLLING DIMENSION: INCH.
  3. DELETED
  4. DIMENSION H IS MEASURED 0.030 (0.762) AWAY FROM PACKAGE BODY.

DIM	INCHES		MILLIMETERS	
	MIN	MAX	MIN	MAX
A	1.335	1.345	33.91	34.16
B	0.380	0.390	9.65	9.91
C	0.125	0.170	3.18	4.32
D	0.495	0.505	12.57	12.83
E	0.035	0.045	0.89	1.14
F	0.003	0.006	0.08	0.15
G	1.100 BSC		27.94 BSC	
H	0.057	0.067	1.45	1.70
K	0.170	0.210	4.32	5.33
M	0.774	0.786	19.66	19.96
N	0.772	0.788	19.60	20.00
Q	∅.118	∅.138	∅.300	∅.351
R	0.365	0.375	9.27	9.53
S	0.365	0.375	9.27	9.52
aaa	0.005 REF		0.127 REF	
bbb	0.010 REF		0.254 REF	
ccc	0.015 REF		0.381 REF	

- STYLE 1:  
 PIN 1. DRAIN  
 2. GATE  
 3. SOURCE

**CASE 465-06  
 ISSUE G  
 NI-780  
 MRF7S15100HR3**



- NOTES:
1. DIMENSIONING AND TOLERANCING PER ANSI Y14.5M-1994.
  2. CONTROLLING DIMENSION: INCH.
  3. DELETED
  4. DIMENSION H IS MEASURED 0.030 (0.762) AWAY FROM PACKAGE BODY.

DIM	INCHES		MILLIMETERS	
	MIN	MAX	MIN	MAX
A	0.805	0.815	20.45	20.70
B	0.380	0.390	9.65	9.91
C	0.125	0.170	3.18	4.32
D	0.495	0.505	12.57	12.83
E	0.035	0.045	0.89	1.14
F	0.003	0.006	0.08	0.15
H	0.057	0.067	1.45	1.70
K	0.170	0.210	4.32	5.33
M	0.774	0.786	19.61	20.02
N	0.772	0.788	19.61	20.02
R	0.365	0.375	9.27	9.53
S	0.365	0.375	9.27	9.52
U	---	0.040	---	1.02
Z	---	0.030	---	0.76
aaa	0.005 REF		0.127 REF	
bbb	0.010 REF		0.254 REF	
ccc	0.015 REF		0.381 REF	

- STYLE 1:  
 PIN 1. DRAIN  
 2. GATE  
 5. SOURCE

**CASE 465A-06  
 ISSUE H  
 NI-780S  
 MRF7S15100HSR3**

## PRODUCT DOCUMENTATION

Refer to the following documents to aid your design process.

### Application Notes

- AN1955: Thermal Measurement Methodology of RF Power Amplifiers

### Engineering Bulletins

- EB212: Using Data Sheet Impedances for RF LDMOS Devices

## REVISION HISTORY

The following table summarizes revisions to this document.

Revision	Date	Description
0	July 2008	<ul style="list-style-type: none"><li>• Initial Release of Data Sheet</li></ul>

## **How to Reach Us:**

### **Home Page:**

[www.freescale.com](http://www.freescale.com)

### **Web Support:**

<http://www.freescale.com/support>

### **USA/Europe or Locations Not Listed:**

Freescale Semiconductor, Inc.  
Technical Information Center, EL516  
2100 East Elliot Road  
Tempe, Arizona 85284  
1-800-521-6274 or +1-480-768-2130  
[www.freescale.com/support](http://www.freescale.com/support)

### **Europe, Middle East, and Africa:**

Freescale Halbleiter Deutschland GmbH  
Technical Information Center  
Schatzbogen 7  
81829 Muenchen, Germany  
+44 1296 380 456 (English)  
+46 8 52200080 (English)  
+49 89 92103 559 (German)  
+33 1 69 35 48 48 (French)  
[www.freescale.com/support](http://www.freescale.com/support)

### **Japan:**

Freescale Semiconductor Japan Ltd.  
Headquarters  
ARCO Tower 15F  
1-8-1, Shimo-Meguro, Meguro-ku,  
Tokyo 153-0064  
Japan  
0120 191014 or +81 3 5437 9125  
[support.japan@freescale.com](mailto:support.japan@freescale.com)

### **Asia/Pacific:**

Freescale Semiconductor China Ltd.  
Exchange Building 23F  
No. 118 Jianguo Road  
Chaoyang District  
Beijing 100022  
China  
+86 10 5879 8000  
[support.asia@freescale.com](mailto:support.asia@freescale.com)

### **For Literature Requests Only:**

Freescale Semiconductor Literature Distribution Center  
P.O. Box 5405  
Denver, Colorado 80217  
1-800-441-2447 or +1-303-675-2140  
Fax: +1-303-675-2150  
[LDCForFreescaleSemiconductor@hibbertgroup.com](mailto:LDCForFreescaleSemiconductor@hibbertgroup.com)

Information in this document is provided solely to enable system and software implementers to use Freescale Semiconductor products. There are no express or implied copyright licenses granted hereunder to design or fabricate any integrated circuits or integrated circuits based on the information in this document.

Freescale Semiconductor reserves the right to make changes without further notice to any products herein. Freescale Semiconductor makes no warranty, representation or guarantee regarding the suitability of its products for any particular purpose, nor does Freescale Semiconductor assume any liability arising out of the application or use of any product or circuit, and specifically disclaims any and all liability, including without limitation consequential or incidental damages. "Typical" parameters that may be provided in Freescale Semiconductor data sheets and/or specifications can and do vary in different applications and actual performance may vary over time. All operating parameters, including "Typicals", must be validated for each customer application by customer's technical experts. Freescale Semiconductor does not convey any license under its patent rights nor the rights of others. Freescale Semiconductor products are not designed, intended, or authorized for use as components in systems intended for surgical implant into the body, or other applications intended to support or sustain life, or for any other application in which the failure of the Freescale Semiconductor product could create a situation where personal injury or death may occur. Should Buyer purchase or use Freescale Semiconductor products for any such unintended or unauthorized application, Buyer shall indemnify and hold Freescale Semiconductor and its officers, employees, subsidiaries, affiliates, and distributors harmless against all claims, costs, damages, and expenses, and reasonable attorney fees arising out of, directly or indirectly, any claim of personal injury or death associated with such unintended or unauthorized use, even if such claim alleges that Freescale Semiconductor was negligent regarding the design or manufacture of the part.

Freescale™ and the Freescale logo are trademarks of Freescale Semiconductor, Inc. All other product or service names are the property of their respective owners.

© Freescale Semiconductor, Inc. 2008. All rights reserved.

