

# Distinctive Characteristics

Snap-acting mechanism gives smooth actuation, short stroke, light touch, and audible feedback. This mechanism also provides long mechanical life.

High torque bushing construction prevents rotation or separation from frame during installation.

Antijamming design protects contacts from damage due to excessive downward force on the actuator.

Compatible companions with M series toggles. Body, bushing, and footprint dimensions ideal for mounting MB2400 pushbuttons and M toggles next to one another.

Stainless steel frame resists corrosion.

Longer center solder lug terminal simplifies wiring and soldering.

Silver contacts of specially composed alloy for hardness.

Epoxy sealed terminals prevent entry of solder flux and other contaminants.

Prominent external insulating barriers increase insulation resistance and dielectric strength.

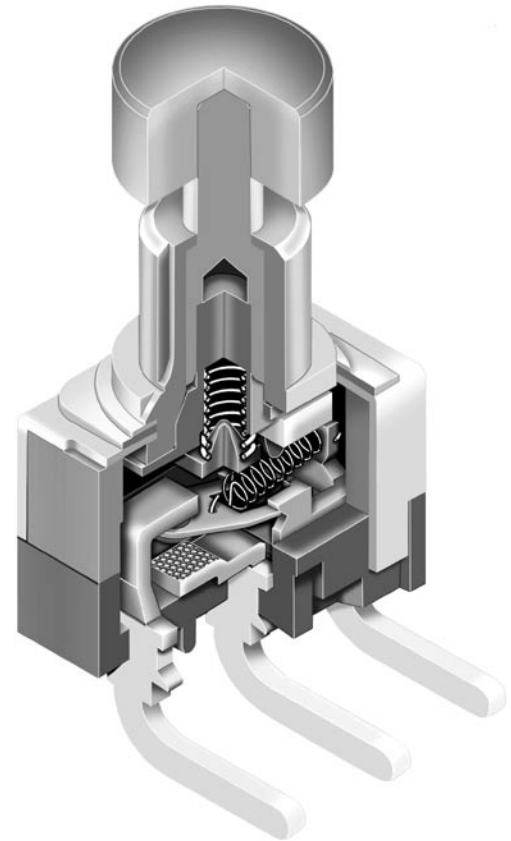

Actual Size

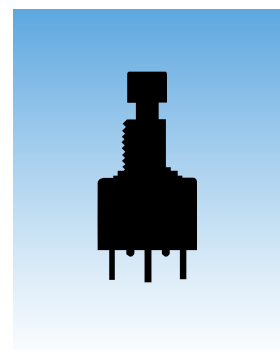

## General Specifications

### Electrical Capacity (Resistive Load)

<b>Power Level (code W):</b>	3A @ 125V AC
<b>Logic Level (code G):</b>	0.4VA maximum @ 28V AC/DC maximum (Applicable Range 0.1mA ~ 0.1A @ 20mV ~ 28V)
<b>Logic/Power Level (code A):</b>	Combines W & G ratings

Note: Find additional explanation of dual rating & operating range in Supplement section.

### Other Ratings

<b>Contact Resistance:</b>	20 milliohms maximum for silver; 30 milliohms maximum for gold
<b>Insulation Resistance:</b>	1,000 megohms minimum @ 500V DC
<b>Dielectric Strength:</b>	1,000V AC minimum between contacts for 1 minute minimum; 1,500V AC minimum between contacts & case for 1 minute minimum
<b>Mechanical Life:</b>	200,000 operations minimum
<b>Electrical Life:</b>	25,000 operations minimum for silver; 100,000 operations minimum for gold
<b>Nominal Operating Force:</b>	Single pole 2.45N; double pole 3.92N
<b>Travel</b>	Pretravel .024" (0.6mm); Overtravel .016" (0.4mm); Total Travel .039" (1.0mm)

### Materials & Finishes

<b>Plunger:</b>	Brass with nickel plating
<b>Bushing:</b>	Brass with nickel plating
<b>Frame:</b>	Stainless steel
<b>Case:</b>	Polybutylene terephthalate (PBT)
<b>Base:</b>	Diallyl phthalate resin
<b>Movable Contactor:</b>	Phosphor bronze with silver or gold plating
<b>Movable Contacts:</b>	Silver alloy (code W); copper with gold plating (code G); or silver alloy with gold plating (code A)
<b>Stationary Contacts:</b>	Silver alloy with silver plating (code W); copper or brass with gold plating (code G); or silver with gold plating (code A)
<b>Terminals:</b>	Copper or brass with silver plating; copper or brass with gold plating

### Environmental Data

<b>Operating Temp Range:</b>	-30°C through +85°C (-22°F through +185°F)
<b>Humidity:</b>	90 ~ 95% humidity for 96 hours @ 40°C (104°F)
<b>Vibration:</b>	10 ~ 55Hz with peak-to-peak amplitude of 1.5mm traversing the frequency range & returning in 1 minute; 3 right angled directions for 2 hours
<b>Shock:</b>	50G (490m/s <sup>2</sup> ) acceleration (tested in 6 right angled directions, with 3 shocks in each direction)

### Installation

<b>Mounting Torque:</b>	1.5Nm (13.0 lb•in) for double nut; 0.7Nm (6.0 lb•in) for single nut
<b>Cap Installation Force:</b>	80.0N (18.0 lbf) maximum downward force on actuator
<b>Soldering:</b>	Wave Soldering (PC version): See Profile B in Supplement section. Manual Soldering: See Profile B in Supplement section.
<b>Cleaning:</b>	These devices are not process sealed. Hand clean locally using alcohol based solution. See Cleaning Specifications in Supplement section.

### Standards & Certifications

<b>Flammability Standards:</b>	UL94V-0 available
<b>UL &amp; C-UL Recognized:</b>	All single and double pole models recognized at 3A @ 125V AC or 0.4VA max. @ 28V DC max; UL File No. WOYR2.E44145; add "/U" to end of part number to order UL mark on switch C-UL File No. WOYR8.E44145; add "/C-UL" to end of part number to order C-UL mark on switch.
<b>CSA Certified:</b>	Single pole models with PC, solder lug, or Wirewrap terminals & double pole with PC or Wirewrap terminals certified at 3A @ 125V AC or 0.4VA @ 28V maximum; CSA File No. 023535-0-000; add "/C" to end of part number to order CSA mark on switch.



### TYPICAL SWITCH ORDERING EXAMPLE

**MB24**

**11**

**A2**

**G**

**40**

**F**

**A**

#### POLES & CIRCUITS

<b>11</b>	SPDT	ON	(ON)
<b>61</b>	DPDT	ON	(ON)
( ) = Momentary			

#### BUSHINGS

<b>A2</b>	.280" (7.1mm) Smooth with Keyway
<b>A1</b>	.280" (7.1mm) Threaded with Keyway
<b>E2</b>	.285" (7.24mm) Smooth with D Flat
<b>E1</b>	.285" (7.24mm) Threaded with D Flat
<b>S2</b>	.350" (8.9mm) Smooth with Keyway
<b>S1</b>	.350" (8.9mm) Threaded with Keyway

#### CONTACT MATERIALS & RATINGS

<b>W</b>	Silver Rated 3A @ 125V AC
<b>G</b>	Gold Rated 0.4VA max @ 28V AC/DC max
<b>A</b>	Gold over Silver Rated 3A @ 125V AC & 0.4VA max @ 28V AC/DC max

#### CAPS

<b>F</b>	.201" (5.1mm) Dia.
<b>H</b>	.295" (7.5mm) Dia.

#### CAP COLORS

<b>A</b>	Black
<b>B</b>	White
<b>C</b>	Red

#### TERMINALS

##### With Bracket

<b>13</b>	.250" (6.35mm) Straight PC with .465" (11.8mm) Bracket
<b>15</b>	.425" (10.8mm) Straight PC with .630" (16.0mm) Bracket
<b>17</b>	.964" (24.5mm) Straight PC with 1.150" (29.2mm) Bracket

##### With Reinforced Bracket

<b>23</b>	.250" (6.35mm) Straight PC with .465" (11.8mm) Bracket
<b>25</b>	.425" (10.8mm) Straight PC with .630" (16.0mm) Bracket
<b>26</b>	.750" (19.05mm) Straight PC with .953" (24.2mm) Bracket

##### With Terminal Support

<b>30</b>	Right Angle PC
<b>32</b>	Right Angle PCB w/Reverse Circuit (1-pole & 0.4VA rating only)
<b>40</b>	Vertical PC

#### IMPORTANT:





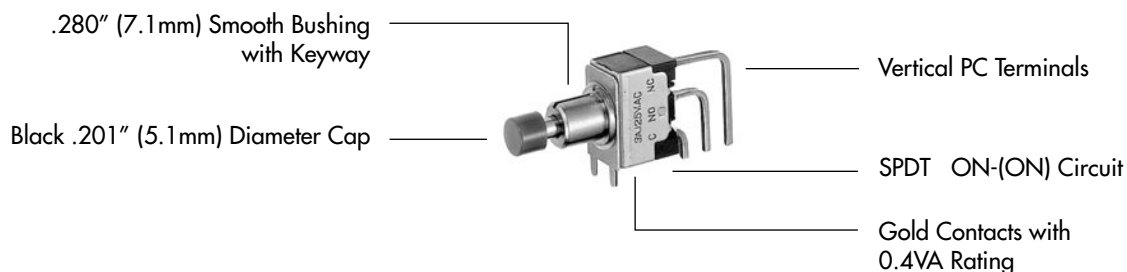

Switches are supplied without UL, C-UL, & CSA markings unless specified. Specific models & ratings noted on General Specifications page.

### DESCRIPTION FOR TYPICAL ORDERING EXAMPLE

**MB2411A2G40-FA**

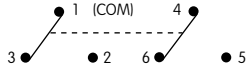

## POLES & CIRCUITS

Pole	Model	Plunger Position ( ) = Momentary		Connected Terminals		Throw & Switch Schematics  Note: Terminal numbers are not actually on the switch. * When using terminal code 32, connected terminals and schematic are reversed.
		Normal  Keyway	Down 	Normal  Keyway	Down 	
SP	*MB2411	ON	(ON)	1-3	1-2	SPDT 
DP	MB2461	ON	(ON)	1-3 4-6	1-2 4-5	DPDT 

## BUSHINGS

Note: Plunger selection is not required for MB2400 pushbuttons.  
The plunger can be used with or without a cap.

**A2** .280" (7.1mm)  
Smooth with Keyway

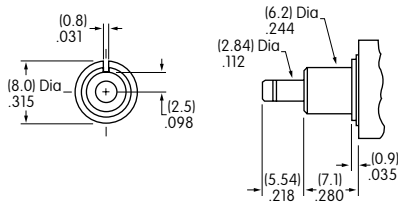

**E2** .285" (7.24mm)  
Smooth with D Flat

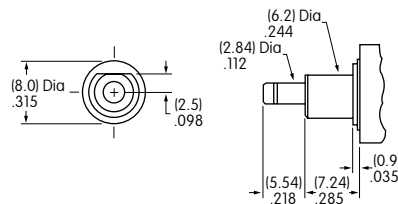

**S2** .350" (8.9mm)  
Smooth with Keyway

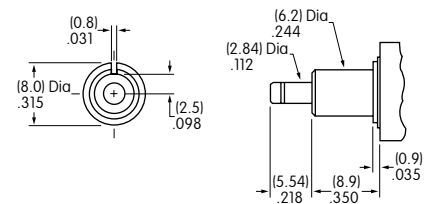

**A1** .280" (7.1mm)  
Threaded with Keyway

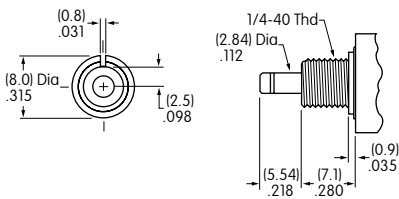

Maximum Panel Thickness with Standard Hardware: .068" (1.74mm)

**E1** .285" (7.24mm)  
Threaded with D Flat

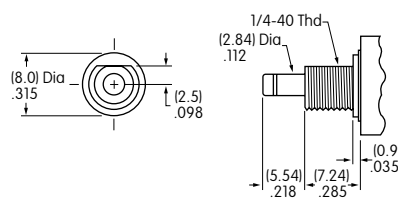

Maximum Panel Thickness with Standard Hardware: .068" (1.74mm)

**S1** .350" (8.9mm)  
Threaded with Keyway

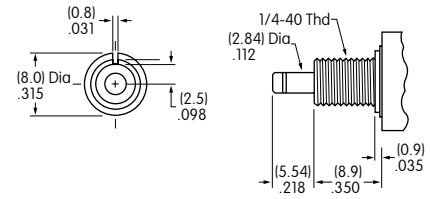

Maximum Panel Thickness with Standard Hardware: .134" (3.40mm)

### Panel Cutouts

For A1, A2, S1, or S2 Bushing with Keyway

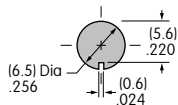

For E1 or E2 Bushing with D Flat

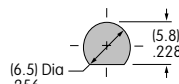

With Optional Locking Ring

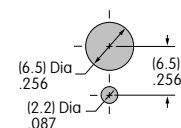

Standard hardware includes 2 hex nuts & 1 lockwasher.  
Hardware is illustrated following the Typical Switch Dimension drawings.

## CONTACT MATERIALS & RATINGS

<b>W</b>	Silver over Silver	Power Level	3A @ 125V AC
<b>G</b>	Gold over Brass or Copper	Logic Level	0.4VA maximum @ 28V AC/DC maximum
Note: Complete explanation of operating range in Supplement section.			
<b>A</b>	Gold over Silver	Power Level or Logic Level	3A @ 125V AC or 0.4VA maximum @ 28V AC/DC maximum

Note: This dual rated option is suitable when two or more identical switches are used in logic and in power circuits within the same application. See Supplement section for complete explanation of dual rating and operating range.

## TERMINALS

### Straight PC Mount with Bracket

**13** .250"  
(6.35mm)  
Terminal w/.465"  
(11.8mm) Bracket

**15** .425"  
(10.8mm)  
Terminal w/.630"  
(16.0mm) Bracket

**17** .964"  
(24.5mm)  
Terminal w/1.150"  
(29.2mm) Bracket

### Straight PC Mount with Reinforced Bracket

**23** .250"  
(6.35mm)  
Terminal w/.465"  
(11.8mm) Bracket

**25** .425"  
(10.8mm)  
Terminal w/.630"  
(16.0mm) Bracket

**26** .750"  
(19.05mm)  
Terminal w/.953"  
(24.2mm) Bracket

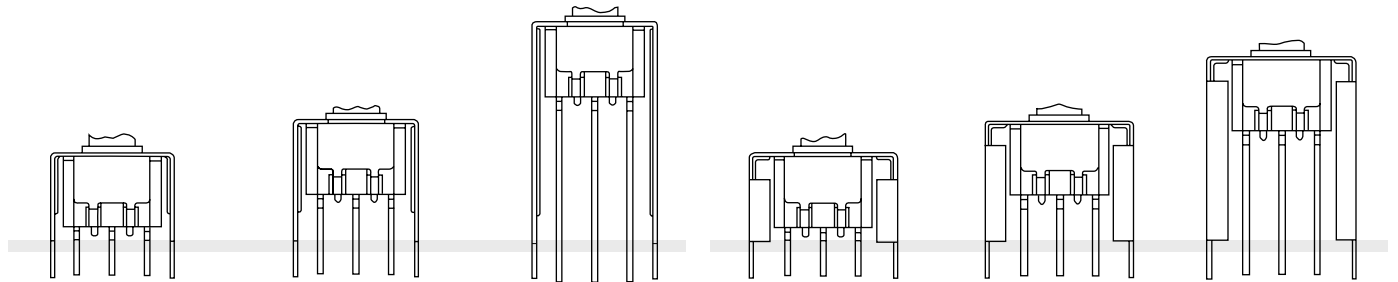

**30** Right Angle PC

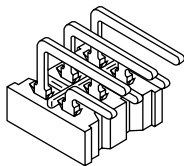

**32** Right Angle PCB w/Reverse Circuit  
Available only in single pole with  
0.4VA rating (code G)

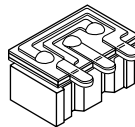

**40** Vertical PC

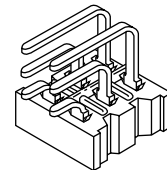

PCB footprints are on the following Typical Switch Dimension pages.

## CAPS & CAP COLORS

**F** AT475  
.201" (5.1mm)  
Diameter Cap

Material: Polyamide

Finish: Glossy

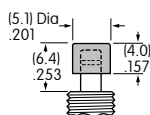

**H** AT496  
.295" (7.5mm)  
Diameter Cap

Material: Polyamide

Finish: Glossy

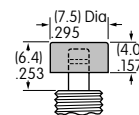

Cap Colors Available:

**A** Black

**B** White

**C** Red

### TYPICAL SWITCH DIMENSIONS

#### Straight PC • Bracket



MB2411A2G13-FA

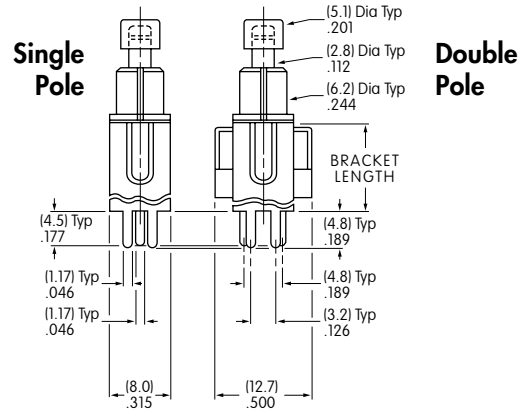
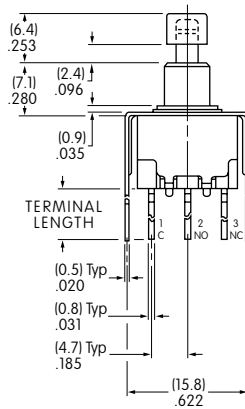

Terminal Code:	Terminal Length:	Bracket Length:
13	.250 (6.35mm)	.465 (11.8mm)
15	.425 (10.8mm)	.630 (16.0mm)
17	.964 (24.5mm)	1.150 (29.2mm)

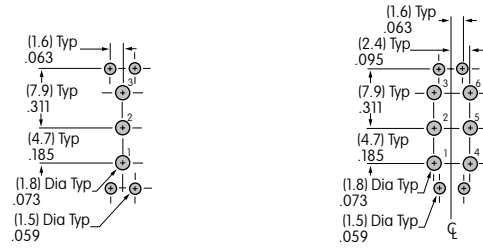

#### Straight PC • Reinforced Bracket



MB2411A2G23-FA

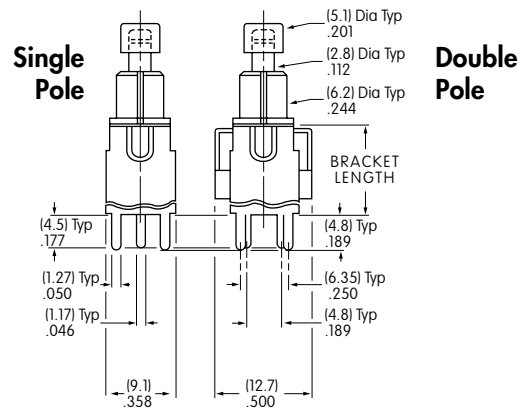
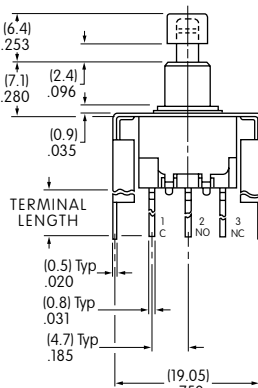

Terminal Code:	Terminal Length:	Bracket Length:
23	.250 (6.35mm)	.465 (11.8mm)
25	.425 (10.8mm)	.630 (16.0mm)
26	.750 (19.05mm)	.953 (24.2mm)

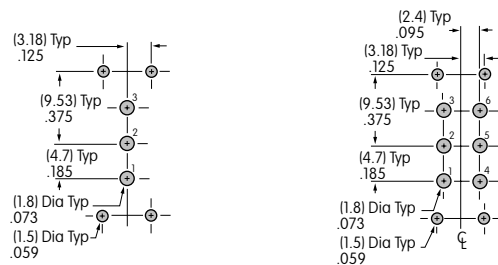

### TYPICAL SWITCH DIMENSIONS

#### Right Angle PC



MB2411A2G30-FA

#### Single Pole

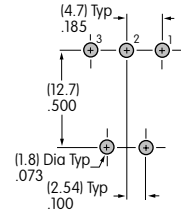
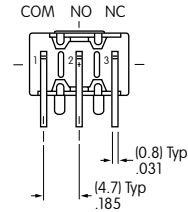
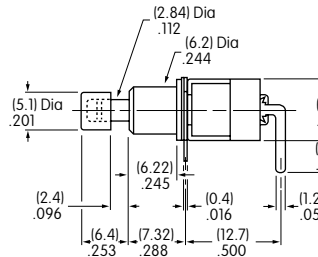
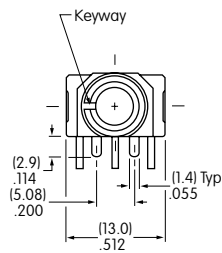

#### Right Angle PC



MB2461A2G30-FA

#### Double Pole

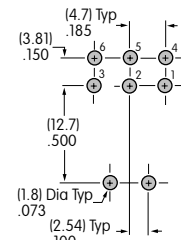
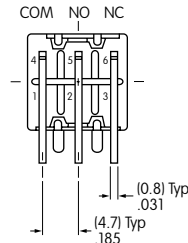
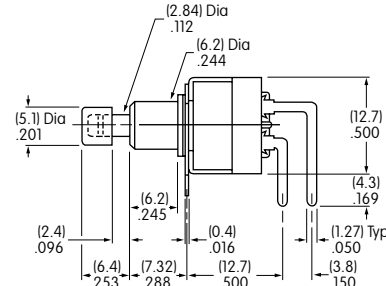
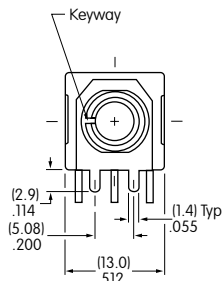

#### Right Angle PCB



MB2411A2G32-FA

#### Single Pole • Reverse Circuit

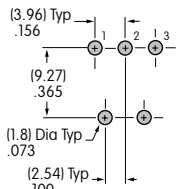
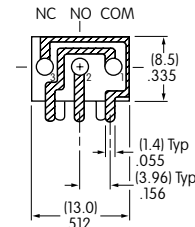
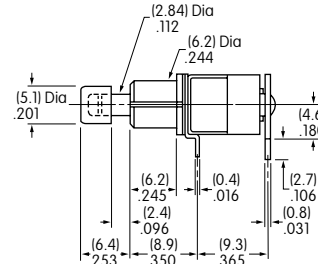
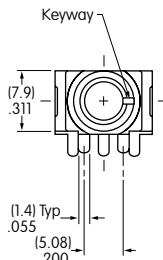

#### Vertical PC



MB2411A2G40-FA

#### Single Pole

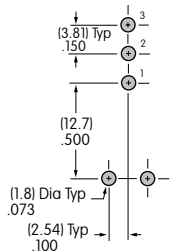
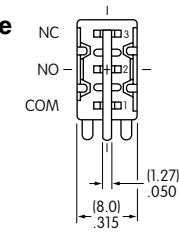
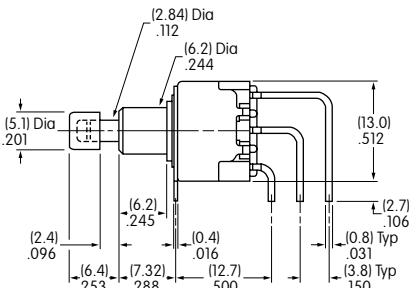
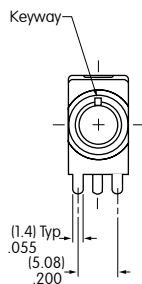

#### Double Pole

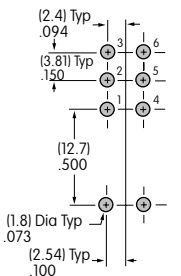
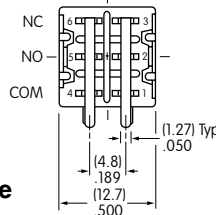

### HARDWARE

#### Standard Hardware

##### AT513H Inch Threaded Hexagon Nut

2 included with each switch

Material:  
Brass with Nickel Plating

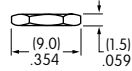
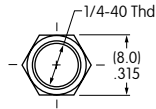

##### AT509 Lockwasher

1 included with each switch

Material:  
Steel with Zinc/Chromate

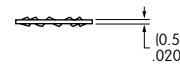
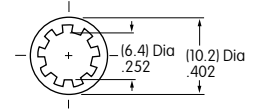

#### Optional Hardware

##### AT507H Locking Ring for A1 or S1 Bushing

Material:  
Steel with Zinc/Chromate

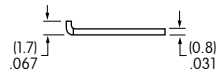
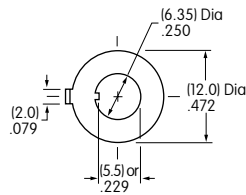

##### AT515 Locking Ring for E1 Bushing

Material:  
Steel with Zinc/Chromate

