

To all our customers

---

## **Regarding the change of names mentioned in the document, such as Mitsubishi Electric and Mitsubishi XX, to Renesas Technology Corp.**

---

The semiconductor operations of Hitachi and Mitsubishi Electric were transferred to Renesas Technology Corporation on April 1st 2003. These operations include microcomputer, logic, analog and discrete devices, and memory chips other than DRAMs (flash memory, SRAMs etc.) Accordingly, although Mitsubishi Electric, Mitsubishi Electric Corporation, Mitsubishi Semiconductors, and other Mitsubishi brand names are mentioned in the document, these names have in fact all been changed to Renesas Technology Corp. Thank you for your understanding. Except for our corporate trademark, logo and corporate statement, no changes whatsoever have been made to the contents of the document, and these changes do not constitute any alteration to the contents of the document itself.

Note : Mitsubishi Electric will continue the business operations of high frequency & optical devices and power devices.

Renesas Technology Corp.  
Customer Support Dept.  
April 1, 2003

MITSUBISHI <LINEAR ICs>  
**M5233L, P, FP**

**DUAL COMPARATOR**

**DESCRIPTION**

The M5233 is a semiconductor circuit for a comparator designed to operate over a wide supply voltage range from 2 to 36V from a single power supply, with two circuits in each 8-pin SIP and 8-pin DIP and 8-pin mini flat package. A differential circuit which is equivalent to a conventional single power supply operational amplifier is used to enable operation from GND level to improve input characteristics. Power dissipation (circuit current) is low and output voltage is large. It fits to a general-purpose comparator for a variety of electronic equipment.

**FEATURES**

- Wide operating supply voltage range ..... 2V~36V  
 Dual power supplies:  $\pm 1V \sim \pm 18V$
- Low circuit current ..... 0.6mA (typ.)
- Wide common mode input voltage range  
 .....  $0V \sim V_{CC} - 1.5V$  (single power supply)
- Open collector output
- Output sink current ..... 25mA
- Response time .....  $1.3\mu\text{sec}$
- Pin compatible with general-purpose comparators 393, 2930

**APPLICATION**

Voltage comparator, window comparator, CR timer, time delay circuit, oscillator, etc.

**RECOMMENDED OPERATING CONDITIONS**

- Supply voltage range ..... 2~36V
- Rated supply voltage ..... 12V

**PIN CONFIGURATION (TOP VIEW)**

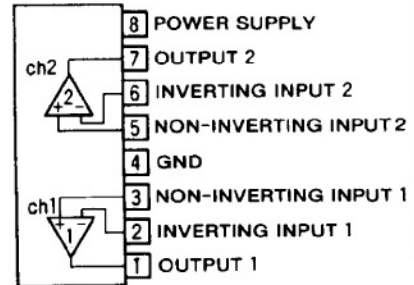

Outline 8P5 (L)

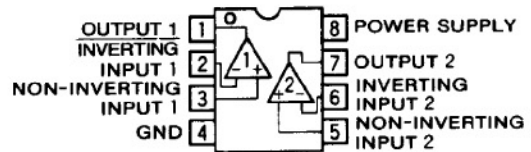

Outline 8P4 (P)

8P2S-A (FP)

**EQUIVALENT CIRCUIT**

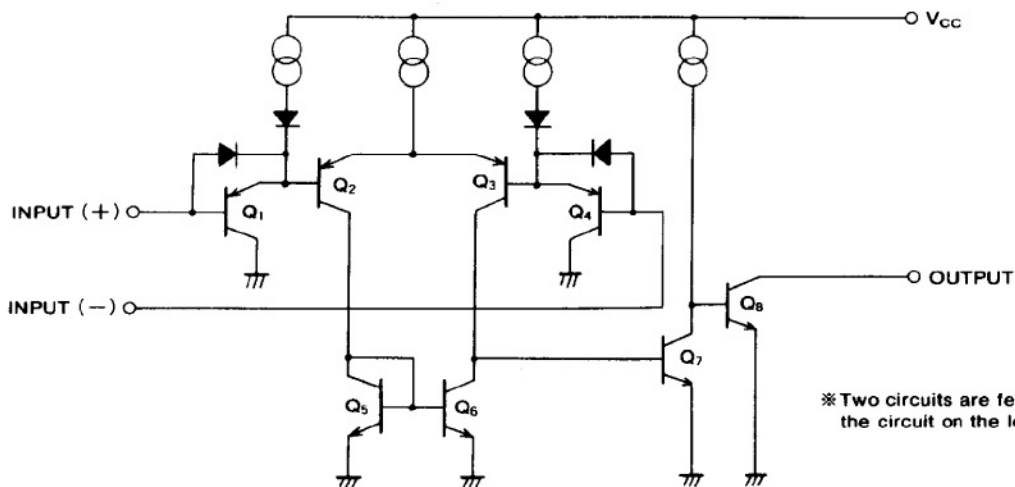

**DUAL COMPARATOR**

**ABSOLUTE MAXIMUM RATINGS** ( $T_a=25^{\circ}\text{C}$ , unless otherwise noted)

Symbol	Parameter	Ratings	Unit
$V_{CC}$	Supply voltage	36( $\pm 18$ )	V
$V_{ID}$	Differential input voltage	36	V
$V_{ICM}$	Common mode input voltage range	-0.3~+36	V
$P_d$	Power dissipation	800(SIP)/625(DIP)/440(FP)	mW
$T_{opr}$	Operating temperature	-20~+75	$^{\circ}\text{C}$
$T_{stg}$	Storage temperature	-55~+125	$^{\circ}\text{C}$

**ELECTRICAL CHARACTERISTICS** ( $T_a=25^{\circ}\text{C}$ ,  $V_{CC}=5\text{V}$ )

Symbol	Parameter	Test conditions	Limits			Unit
			Min	Typ	Max	
$V_{IO}$	Input offset voltage	$V_O=1.4\text{V}$ , $V_{REF}=1.4\text{V}$ , $R_S=0\Omega$		2	5	mV
$I_{IO}$	Input offset current			5	50	nA
$I_B$	Input bias current			25	250	nA
$V_{ICM}$	Common mode input voltage range		0		$V_{CC}-1.5$	V
$G_V$	Voltage gain	$R_L=15\text{k}\Omega$		200		V/mV
$I_{CC}$	Circuit current	$R_L=\infty$		0.6	1	mA
$t_{PLH}$	Response time	$R_L=5.1\text{k}\Omega$ , $V_{RL}=5\text{V}$		1.3		$\mu\text{sec}$
$I_{sink}$	Output sink current	$V_{IN(-)}=1\text{V}$ , $V_{IN(+)}=0\text{V}$ , $V_O\leq 1.5\text{V}$	10	25		mA
$V_{OL}$	Output saturation voltage	$V_{IN(-)}=1\text{V}$ , $V_{IN(+)}=0\text{V}$ , $I_{sink}=8\text{mA}$		200	400	mV
$I_{LO}$	Output leak current	$V_{IN(+)}=1\text{V}$ , $V_{IN(-)}=0\text{V}$ , $V_O=5\text{V}$		0.1		nA

**TYPICAL CHARACTERISTICS**

**THERMAL DERATING (MAXIMUM RATING)**

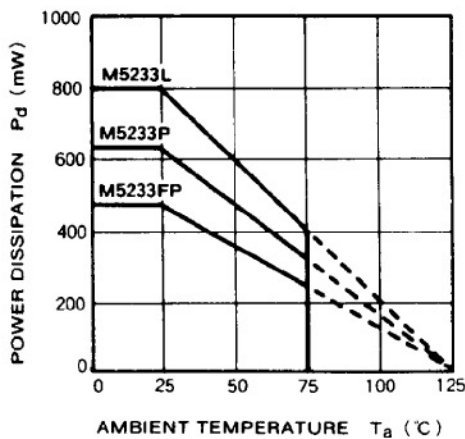

**CIRCUIT CURRENT VS. SUPPLY VOLTAGE**

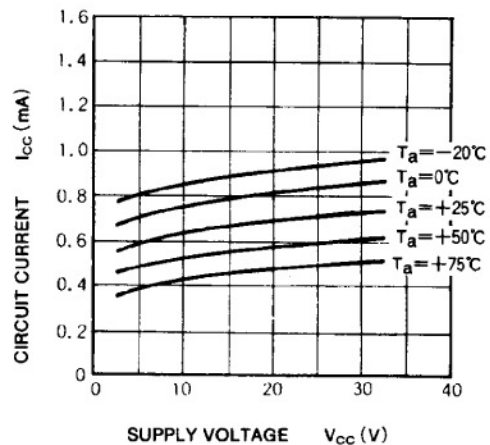

**INPUT BIAS CURRENT VS. SUPPLY VOLTAGE**

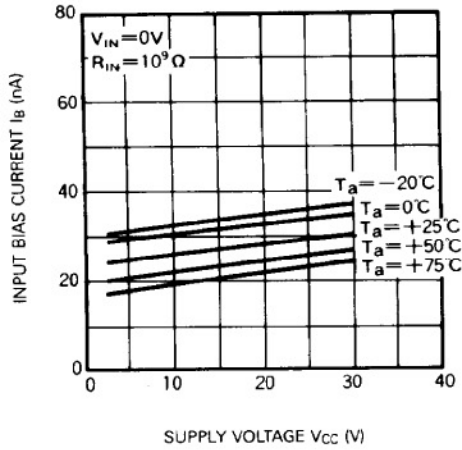

**OUTPUT SATURATION VOLTAGE VS. OUTPUT SINK CURRENT**

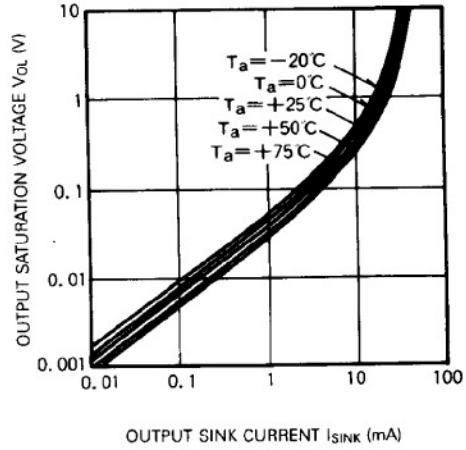

**RESPONSE TIME FOR VARIOUS INPUT OVERDRIVES VS. NEGATIVE TRANSITION**

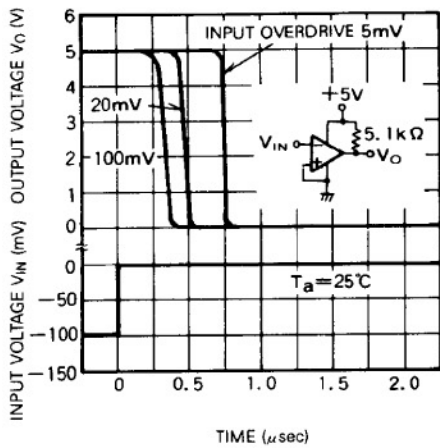

**RESPONSE TIME FOR VARIOUS INPUT OVERDRIVES VS. NEGATIVE TRANSITION**

