

RM20TPM-H

MEDIUM POWER GENERAL USE
INSULATED TYPE

RM20TPM-H



- **I_o** DC output current **40A**
- **V_{RRM}** Repetitive peak reverse voltage
..... **800V**
- **3 phase bridge**
- **Insulated Type**

APPLICATION

AC motor controllers, DC motor controllers, Battery DC power supplies,
DC power supplies for control panels, and other general DC power equipment

OUTLINE DRAWING & CIRCUIT DIAGRAM

Dimensions in mm

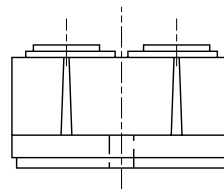
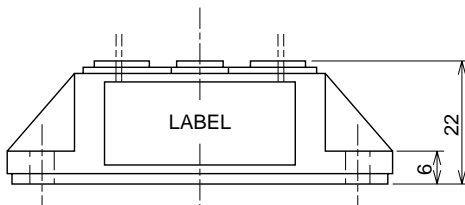
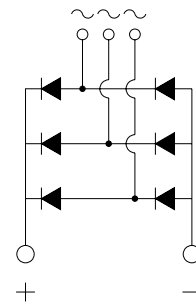
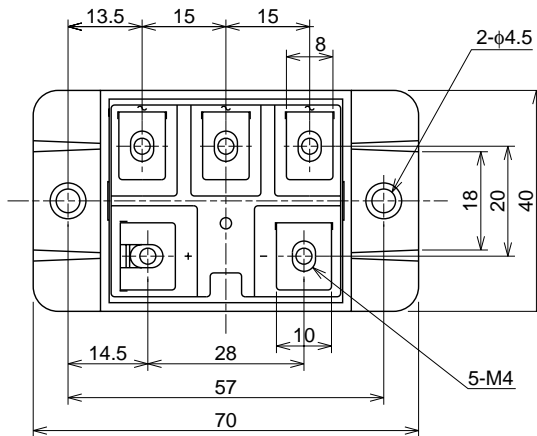

RM20TPM-H

MEDIUM POWER GENERAL USE
INSULATED TYPE

ABSOLUTE MAXIMUM RATINGS

| Symbol | Parameter | Voltage class | | Unit |
|--------|-------------------------------------|---------------|-----|------|
| | | | H | |
| VRRM | Repetitive peak reverse voltage | | 800 | V |
| VRSM | Non-repetitive peak reverse voltage | | 900 | V |
| Ea | Recommended AC input voltage | | 220 | V |

| Symbol | Parameter | Conditions | Ratings | Unit |
|-----------------------------|--|---|-----------------------|------------------|
| I _o | DC output current | Three-phase full wave rectifying circuit, T _c =125°C | 40 | A |
| I _{FSM} | Surge (non-repetitive) forward current | One half cycle at 60Hz, peak value | 400 | A |
| I _t ² | I _t ² for fusing | Value for one cycle of surge current | 4.2 × 10 ³ | A ² s |
| f | Maximum operating frequency | | 1000 | Hz |
| T _j | Junction temperature | | -40~+150 | °C |
| T _{stg} | Storage temperature | | -40~+125 | °C |
| V _{iso} | Isolation voltage | Charged part to case | 2500 | V |
| — | Mounting torque | Main terminal screw M4 | 0.98~1.47 | N·m |
| | | | 10~15 | kg·cm |
| | | Mounting screw M4 | 0.98~1.47 | N·m |
| | | | 10~15 | kg·cm |
| — | Weight | Typical value | 100 | g |

ELECTRICAL CHARACTERISTICS

| Symbol | Parameter | Test conditions | Limits | | | Unit |
|----------------------|----------------------------|---|--------|------|------|------|
| | | | Min. | Typ. | Max. | |
| I _{RRM} | Repetitive reverse current | T _j =150°C, V _{RRM} applied | — | — | 10 | mA |
| V _{FM} | Forward voltage | T _j =25°C, I _{FM} =40A, instantaneous meas. | — | — | 1.2 | V |
| R _{th(j-c)} | Thermal resistance | Junction to case | — | — | 0.33 | °C/W |
| R _{th(c-f)} | Contact thermal resistance | Case to fin, conductive grease applied | — | — | 0.09 | °C/W |
| — | Insulation resistance | Measured with a 500V megohmmeter between main terminal and case | 10 | — | — | MΩ |

RM20TPM-H

MEDIUM POWER GENERAL USE
INSULATED TYPE

PERFORMANCE CURVES

MAXIMUM FORWARD CHARACTERISTIC

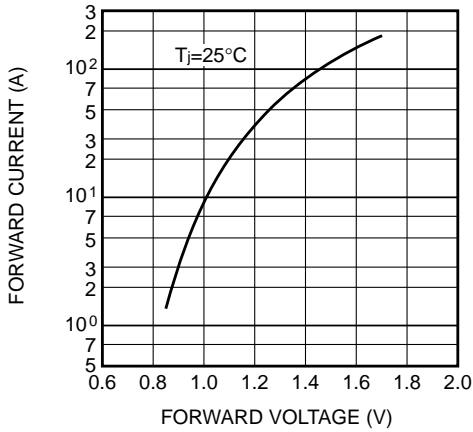

ALLOWABLE SURGE (NON-REPETITIVE) FORWARD CURRENT

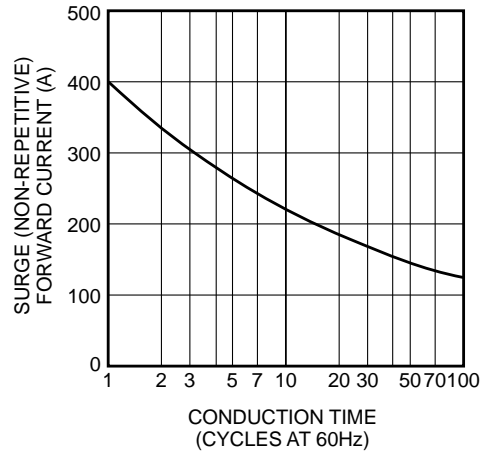

MAXIMUM TRANSIENT THERMAL IMPEDANCE (JUNCTION TO CASE)

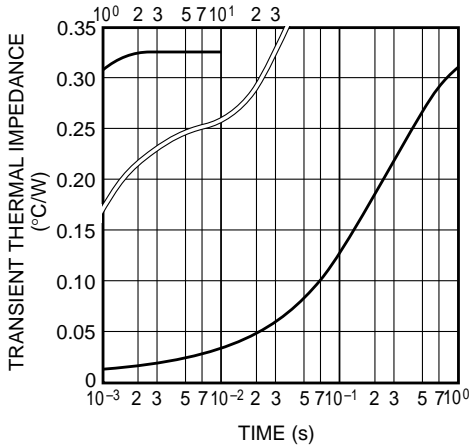

MAXIMUM POWER DISSIPATION

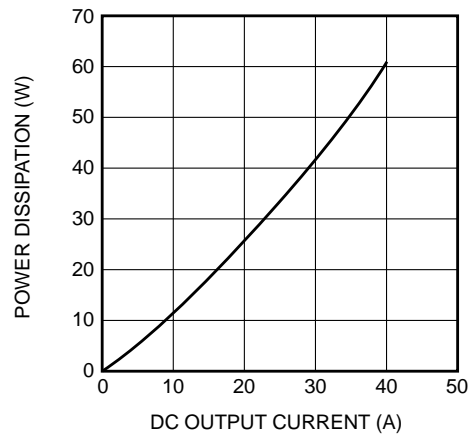

ALLOWABLE CASE TEMPERATURE VS. DC OUTPUT CURRENT

