

AON6718L
N-Channel Enhancement Mode Field Effect Transistor
SRFET™

General Description	Features
SRFET™ AON6718L uses advanced trench technology with a monolithically integrated Schottky diode to provide excellent $R_{DS(ON)}$ and low gate charge. This device is ideally suited for use as a low side switch in CPU core power conversion.	V_{DS} (V) = 30V I_D = 80A ($V_{GS} = 10V$) $R_{DS(ON)} < 3.7m\Omega$ ($V_{GS} = 10V$) $R_{DS(ON)} < 5m\Omega$ ($V_{GS} = 4.5V$)
<ul style="list-style-type: none"> - RoHS Compliant - Halogen Free 	100% UIS Tested! 100% R_g Tested!

Fits SOIC8 footprint !

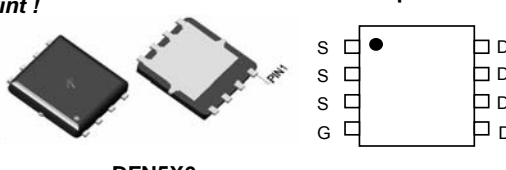

DFN5X6

Top View

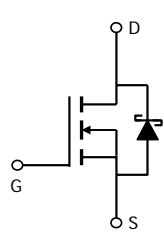

SRFET™
 Soft Recovery MOSFET:
 Integrated Schottky Diode

Absolute Maximum Ratings $T_A=25^\circ\text{C}$ unless otherwise noted

Parameter	Symbol	Maximum	Units
Drain-Source Voltage	V_{DS}	30	V
Gate-Source Voltage	V_{GS}	± 20	V
Continuous Drain Current ^G	I_D	$T_C=25^\circ\text{C}$	80
		$T_C=100^\circ\text{C}$	63
Pulsed Drain Current ^C	I_{DM}	210	A
Continuous Drain Current	I_{DSM}	$T_A=25^\circ\text{C}$	19
		$T_A=70^\circ\text{C}$	15
Avalanche Current ^C	I_{AR}	40	A
Repetitive avalanche energy $L=0.1\text{mH}$ ^C	E_{AR}	80	mJ
Power Dissipation ^B	P_D	$T_C=25^\circ\text{C}$	83
		$T_C=100^\circ\text{C}$	33
Power Dissipation ^A	P_{DSM}	$T_A=25^\circ\text{C}$	2.5
		$T_A=70^\circ\text{C}$	1.6
Junction and Storage Temperature Range	T_J, T_{STG}	-55 to 150	$^\circ\text{C}$

Thermal Characteristics

Parameter	Symbol	Typ	Max	Units
Maximum Junction-to-Ambient ^A	$R_{\theta JA}$	$t \leq 10\text{s}$	14.2	$^\circ\text{C/W}$
Maximum Junction-to-Ambient ^{A D}		Steady-State	42	$^\circ\text{C/W}$
Maximum Junction-to-Case	$R_{\theta JC}$	1.2	1.5	$^\circ\text{C/W}$

Electrical Characteristics (T_J=25°C unless otherwise noted)

Symbol	Parameter	Conditions	Min	Typ	Max	Units
STATIC PARAMETERS						
BV _{DSS}	Drain-Source Breakdown Voltage	I _D =250μA, V _{GS} =0V	30			V
I _{DSS}	Zero Gate Voltage Drain Current	V _{DS} =30V, V _{GS} =0V T _J =125°C		0.025	0.1	mA
I _{GSS}	Gate-Body leakage current	V _{DS} =0V, V _{GS} = ±20V			0.1	
V _{GS(th)}	Gate Threshold Voltage	V _{DS} =V _{GS} , I _D =250μA	1.2	1.8	2.2	V
I _{D(ON)}	On state drain current	V _{GS} =10V, V _{DS} =5V	160			A
R _{DS(ON)}	Static Drain-Source On-Resistance	V _{GS} =10V, I _D =20A T _J =125°C		3.1	3.7	mΩ
		V _{GS} =4.5V, I _D =20A		4.3	5.2	
g _{FS}	Forward Transconductance	V _{DS} =5V, I _D =20A		87		S
V _{SD}	Diode Forward Voltage	I _S =1A, V _{GS} =0V		0.4	1	V
I _S	Maximum Body-Diode Continuous Current				40	A
DYNAMIC PARAMETERS						
C _{iss}	Input Capacitance	V _{GS} =0V, V _{DS} =15V, f=1MHz	2975	3719	4463	pF
C _{oss}	Output Capacitance		485	693	900	pF
C _{rss}	Reverse Transfer Capacitance		204	340	476	pF
R _g	Gate resistance	V _{GS} =0V, V _{DS} =0V, f=1MHz	0.28	0.56	0.84	Ω
SWITCHING PARAMETERS						
Q _g (10V)	Total Gate Charge	V _{GS} =10V, V _{DS} =15V, I _D =20A	48	60	72	nC
Q _g (4.5V)	Total Gate Charge		20	25	30	nC
Q _{gs}	Gate Source Charge		12	15	18	nC
Q _{gd}	Gate Drain Charge		6	10	14	nC
t _{D(on)}	Turn-On Delay Time	V _{GS} =10V, V _{DS} =15V, R _L =0.75Ω, R _{GEN} =3Ω		9.2		ns
t _r	Turn-On Rise Time			10.7		ns
t _{D(off)}	Turn-Off Delay Time			40		ns
t _f	Turn-Off Fall Time			12.5		ns
t _{rr}	Body Diode Reverse Recovery Time	I _F =20A, dI/dt=500A/μs	10	13	16	ns
Q _{rr}	Body Diode Reverse Recovery Charge	I _F =20A, dI/dt=500A/μs	21	26.5	32	nC

A. The value of R_{θJA} is measured with the device mounted on 1 in² FR-4 board with 2oz. Copper, in a still air environment with T_A=25°C. The Power dissipation P_{DSM} is based on R_{θJA} and the maximum allowed junction temperature of 150°C. The value in any given application depends on the user's specific board design.

B. The power dissipation P_D is based on T_{J(MAX)}=150°C, using junction-to-case thermal resistance, and is more useful in setting the upper dissipation limit for cases where additional heatsinking is used.

C. Repetitive rating, pulse width limited by junction temperature T_{J(MAX)}=150°C. Ratings are based on low frequency and duty cycles to keep initial T_J=25°C.

D. The R_{θJA} is the sum of the thermal impedance from junction to case R_{θJC} and case to ambient.

E. The static characteristics in Figures 1 to 6 are obtained using <30μs pulses, duty cycle 0.5% max.

F. These curves are based on the junction-to-case thermal impedance which is measured with the device mounted to a large heatsink, assuming a maximum junction temperature of T_{J(MAX)}=150°C. The SOA curve provides a single pulse rating.

G. The maximum current rating is limited by bond-wires.

H. These tests are performed with the device mounted on 1 in² FR-4 board with 2oz. Copper, in a still air environment with T_A=25°C.

Rev0: Oct-08

COMPONENTS IN LIFE SUPPORT DEVICES OR SYSTEMS ARE NOT AUTHORIZED. AOS DOES NOT ASSUME ANY LIABILITY ARISING OUT OF SUCH APPLICATIONS OR USES OF ITS PRODUCTS. AOS RESERVES THE RIGHT TO IMPROVE PRODUCT DESIGN, FUNCTIONS AND RELIABILITY WITHOUT NOTICE.

TYPICAL ELECTRICAL AND THERMAL CHARACTERISTICS

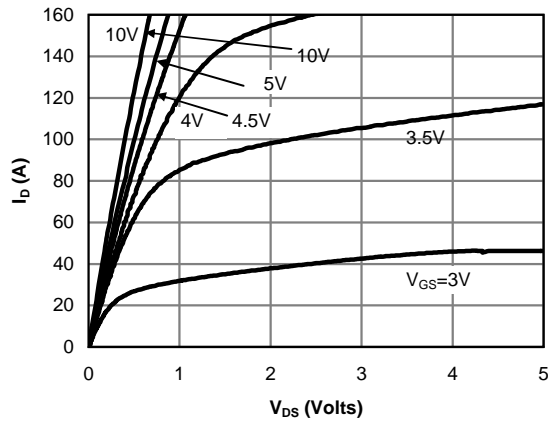

Fig 1: On-Region Characteristics (Note E)

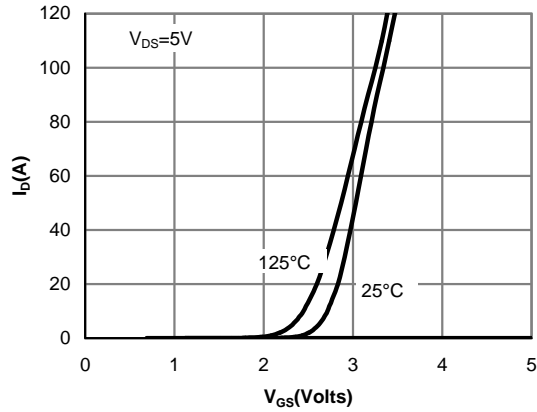

Figure 2: Transfer Characteristics (Note E)

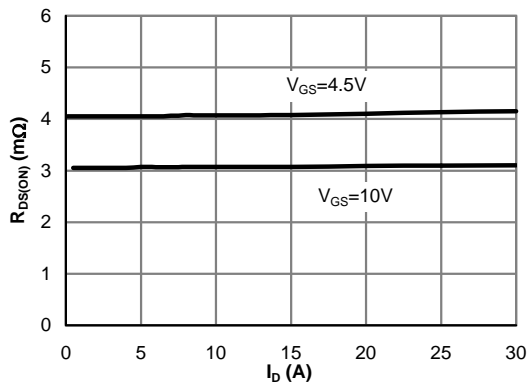

Figure 3: On-Resistance vs. Drain Current and Gate Voltage (Note E)

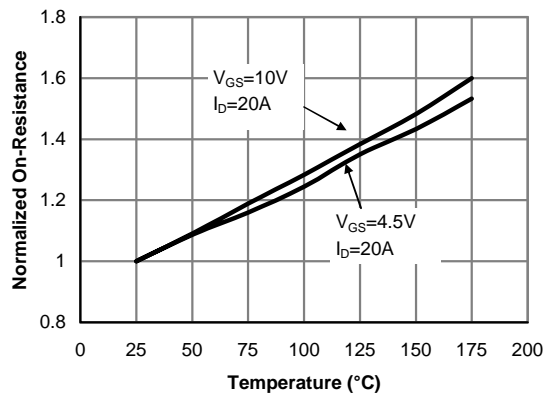

Figure 4: On-Resistance vs. Junction Temperature (Note E)

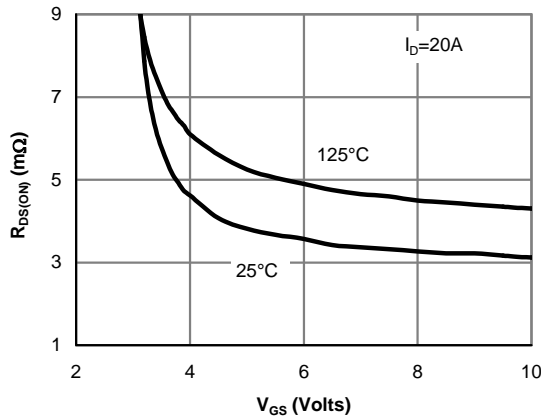

Figure 5: On-Resistance vs. Gate-Source Voltage (Note E)

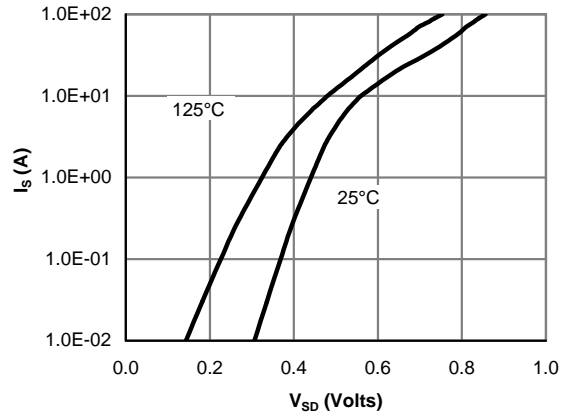

Figure 6: Body-Diode Characteristics (Note E)

TYPICAL ELECTRICAL AND THERMAL CHARACTERISTICS

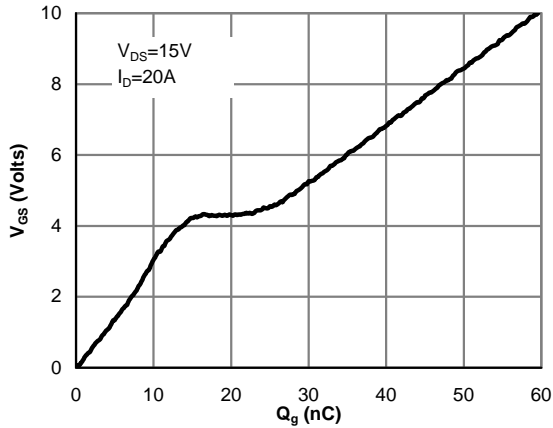

Figure 7: Gate-Charge Characteristics

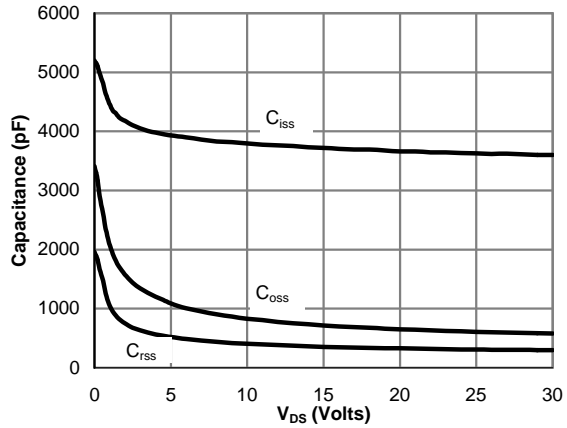

Figure 8: Capacitance Characteristics

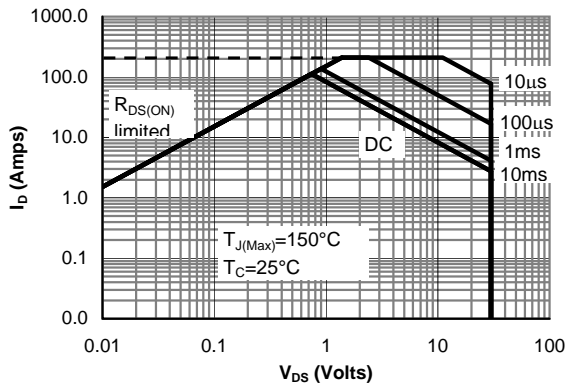

Figure 9: Maximum Forward Biased Safe Operating Area (Note F)

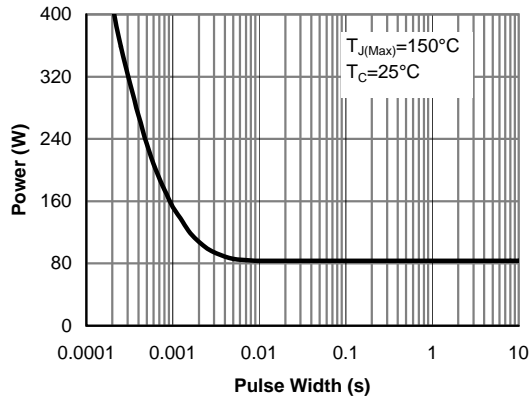

Figure 10: Single Pulse Power Rating Junction-to-Case (Note F)

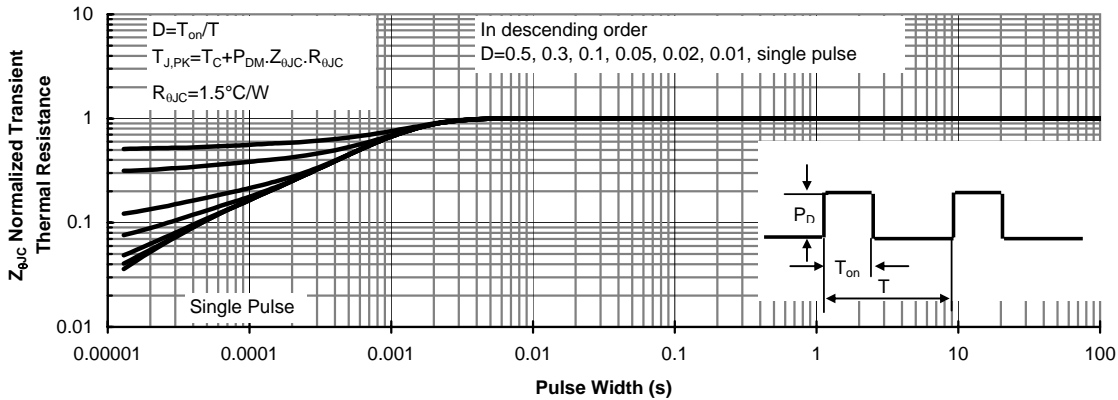

Figure 11: Normalized Maximum Transient Thermal Impedance (Note F)

TYPICAL ELECTRICAL AND THERMAL CHARACTERISTICS

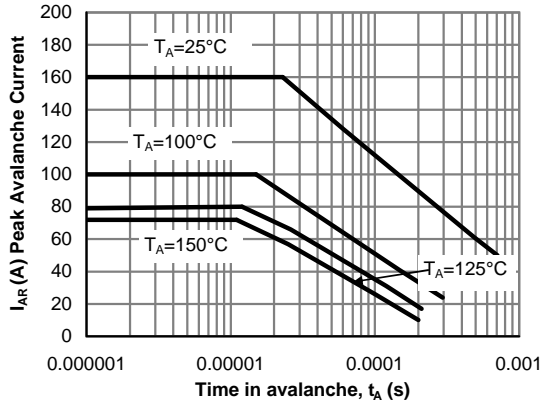

Figure 12: Single Pulse Avalanche capability (Note C)

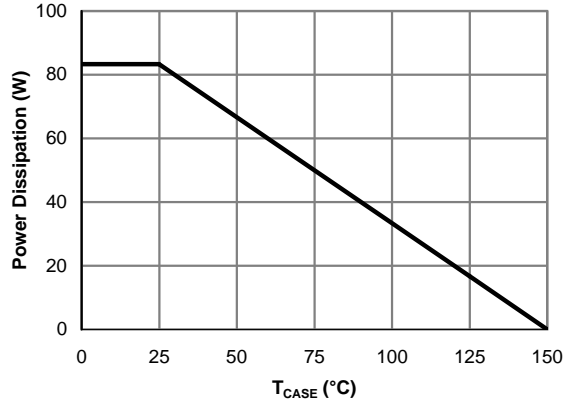

Figure 13: Power De-rating (Note F)

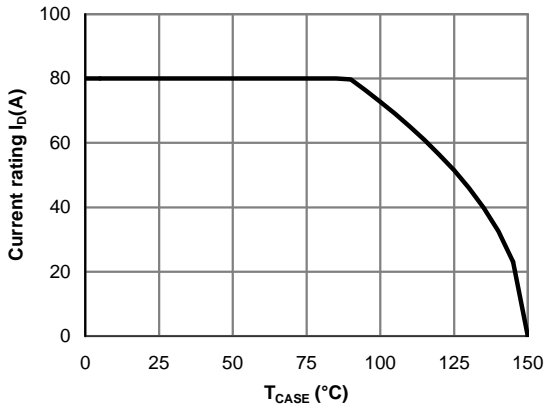

Figure 14: Current De-rating (Note F)

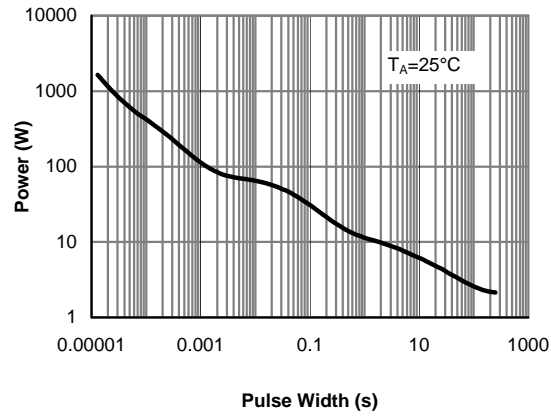

Figure 15: Single Pulse Power Rating Junction-to-Ambient (Note H)

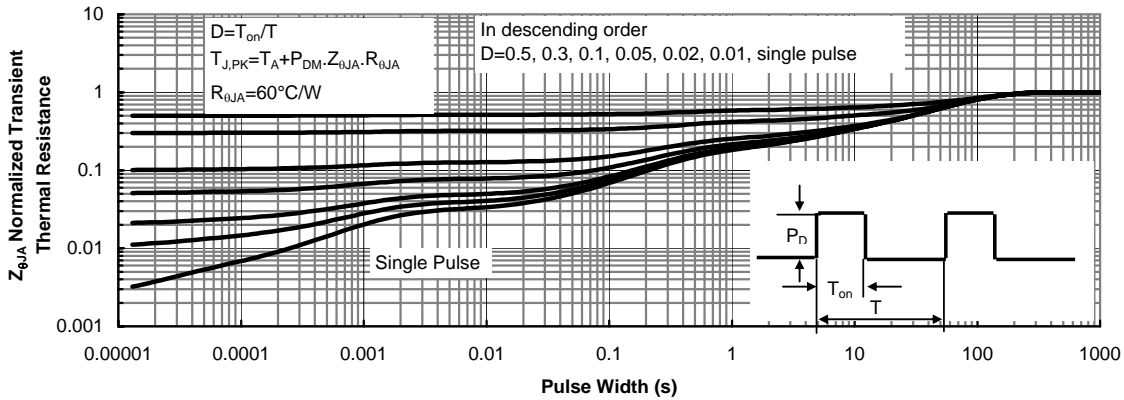

Figure 16: Normalized Maximum Transient Thermal Impedance (Note H)

TYPICAL ELECTRICAL AND THERMAL CHARACTERISTICS

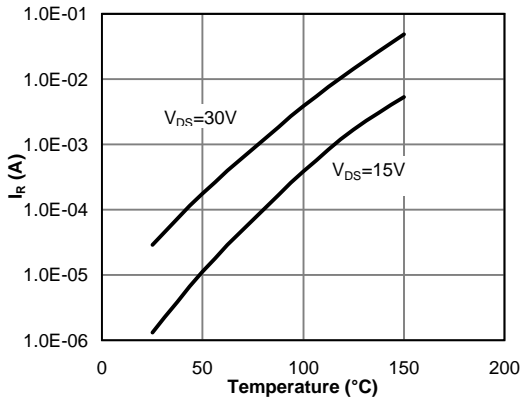

Figure 17: Diode Reverse Leakage Current vs. Junction Temperature

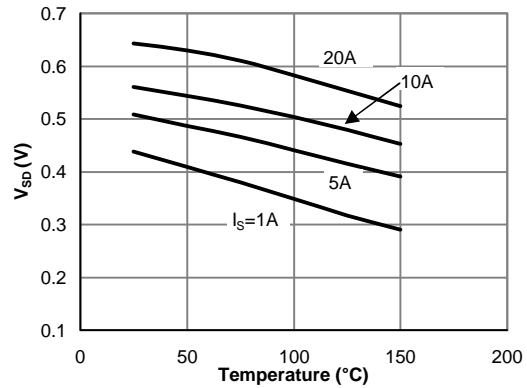

Figure 18: Diode Forward voltage vs. Junction Temperature

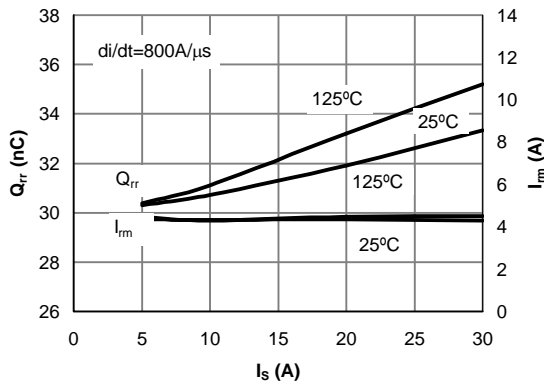

Figure 19: Diode Reverse Recovery Charge and Peak Current vs. Conduction Current

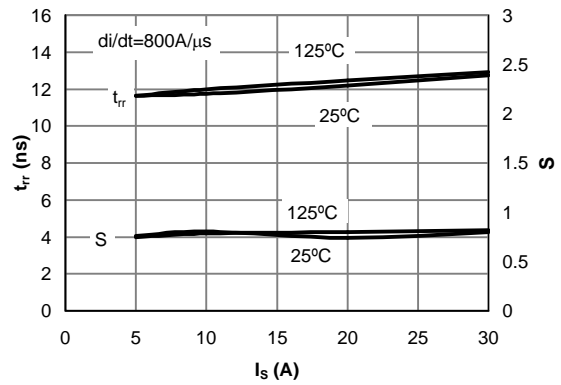

Figure 20: Diode Reverse Recovery Time and Softness Factor vs. Conduction Current

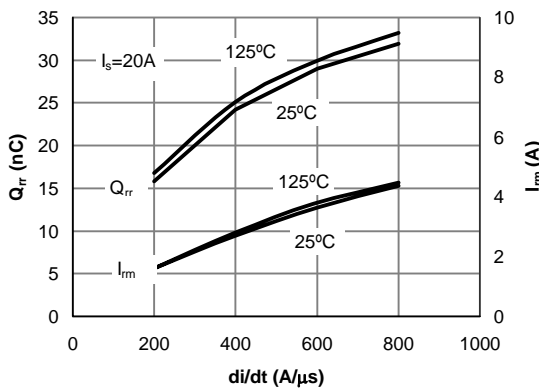

Figure 21: Diode Reverse Recovery Charge and Peak Current vs. di/dt

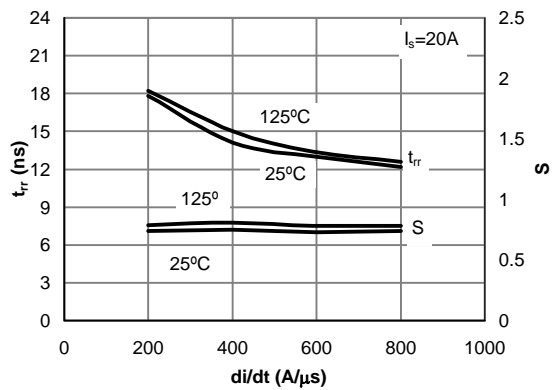
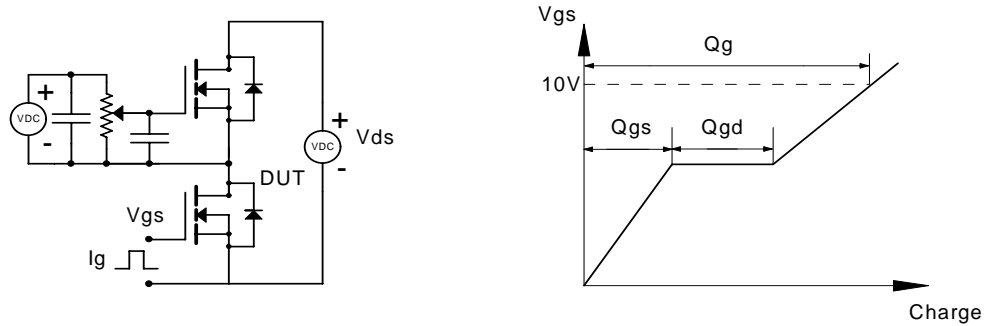
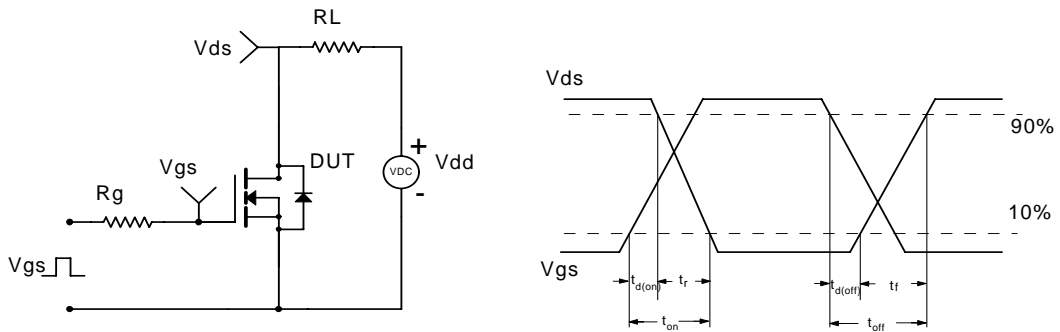

Figure 22: Diode Reverse Recovery Time and Softness Factor vs. di/dt

Gate Charge Test Circuit & Waveform



Resistive Switching Test Circuit & Waveforms



Unclamped Inductive Switching (UIS) Test Circuit & Waveforms

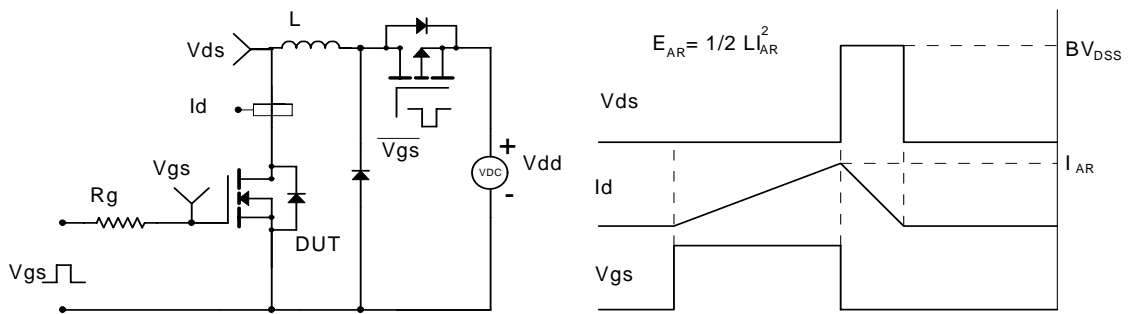

Diode Recovery Test Circuit & Waveforms

