

## Silicon NPN Power Transistors

2SC3895

## DESCRIPTION

- With TO-3PML package
- High speed
- High breakdown voltage
- High reliability

## APPLICATIONS

- Ultrahigh-definition CRT display horizontal deflection output applications

## PINNING

PIN	DESCRIPTION
1	Base
2	Collector
3	Emitter

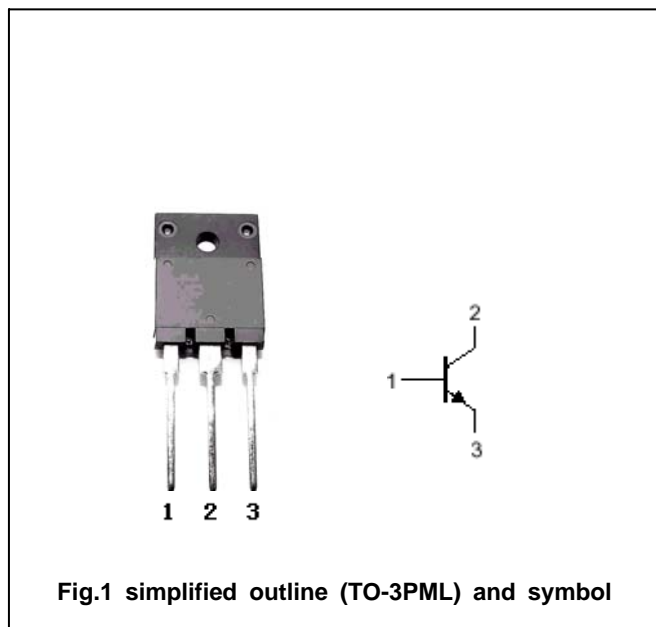

## Absolute maximum ratings (Ta=25°C)

SYMBOL	PARAMETER	CONDITIONS	MAX	UNIT
$V_{CBO}$	Collector-base voltage	Open emitter	1500	V
$V_{CEO}$	Collector-emitter voltage	Open base	800	V
$V_{EBO}$	Emitter-base voltage	Open collector	6	V
$I_C$	Collector current		7	A
$I_{CM}$	Collector current-peak		16	A
$P_C$	Collector dissipation	Ta=25°C	3.0	W
		Tc=25°C	60	
$T_j$	Junction temperature		150	°C
$T_{stg}$	Storage temperature		-55~150	°C

## Silicon NPN Power Transistors

## 2SC3895

## CHARACTERISTICS

T<sub>j</sub>=25°C unless otherwise specified

SYMBOL	PARAMETER	CONDITIONS	MIN	TYP.	MAX	UNIT
V <sub>CE0(SUS)</sub>	Collector-emitter sustaining voltage	I <sub>C</sub> =0.1A ; I <sub>B</sub> =0	800			V
V <sub>CEsat</sub>	Collector-emitter saturation voltage	I <sub>C</sub> =5A ; I <sub>B</sub> =1.2A			5.0	V
V <sub>BEsat</sub>	Base-emitter saturation voltage	I <sub>C</sub> =5A ; I <sub>B</sub> =1.2A			1.5	V
I <sub>CBO</sub>	Collector cut-off current	V <sub>CB</sub> =800V ; I <sub>E</sub> =0			10	μ A
I <sub>CES</sub>	Collector cut-off current	V <sub>CE</sub> =1500V ; R <sub>BE</sub> =0			1.0	mA
I <sub>EBO</sub>	Emitter cut-off current	V <sub>EB</sub> =4V ; I <sub>C</sub> =0			1.0	mA
h <sub>FE-1</sub>	DC current gain	I <sub>C</sub> =1A ; V <sub>CE</sub> =5V	8			
h <sub>FE-2</sub>	DC current gain	I <sub>C</sub> =5A ; V <sub>CE</sub> =5V	4		8	

## Switching times

t <sub>stg</sub>	Storage time	I <sub>C</sub> =4A ; V <sub>CC</sub> =200V I <sub>B1</sub> =0.8A ; I <sub>B2</sub> =1.6A R <sub>L</sub> =50 Ω			3.0	μ s
t <sub>f</sub>	Fall time			0.1	0.2	μ s

Silicon NPN Power Transistors

2SC3895

PACKAGE OUTLINE

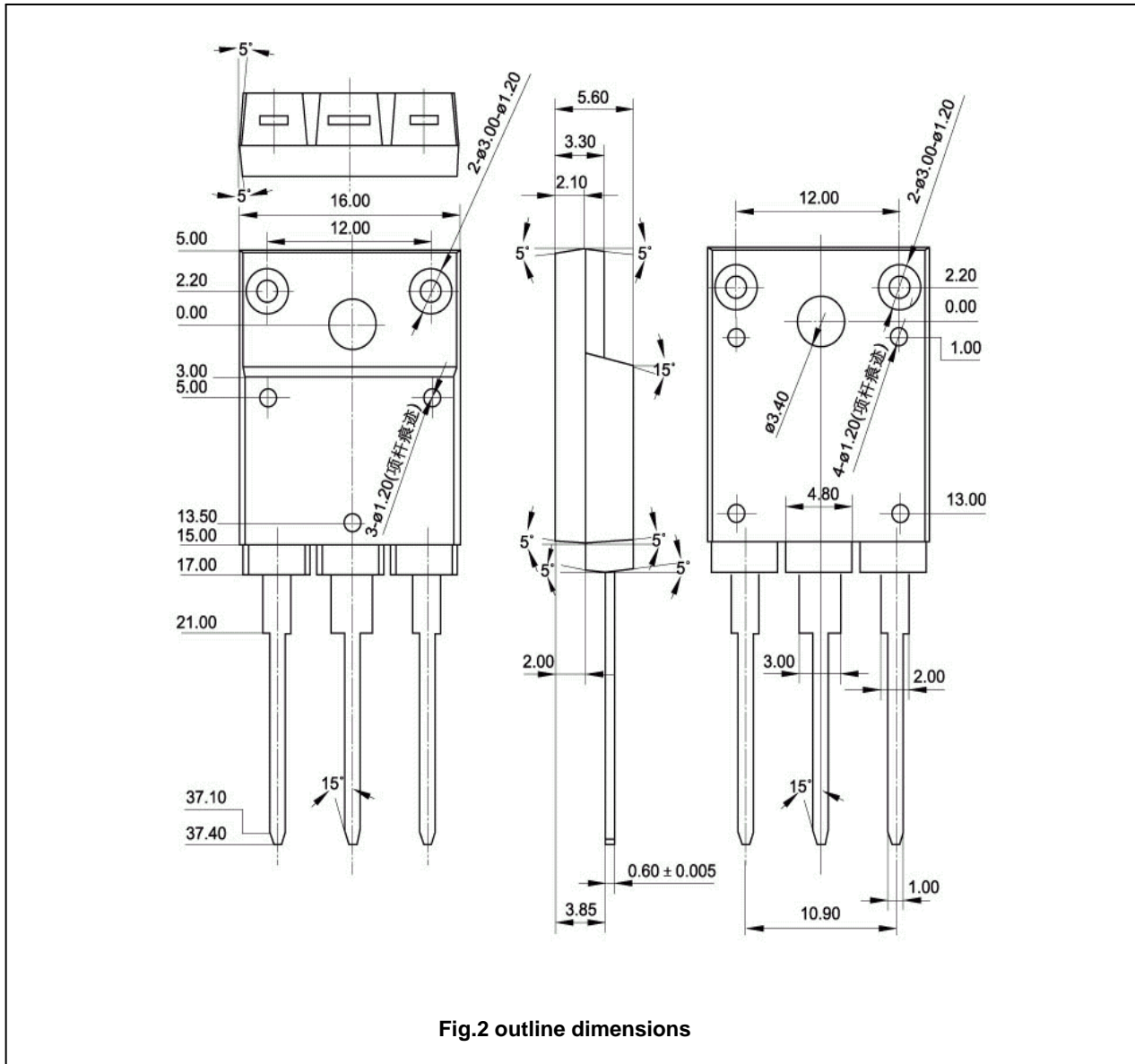

Fig.2 outline dimensions

Silicon NPN Power Transistors

2SC3895

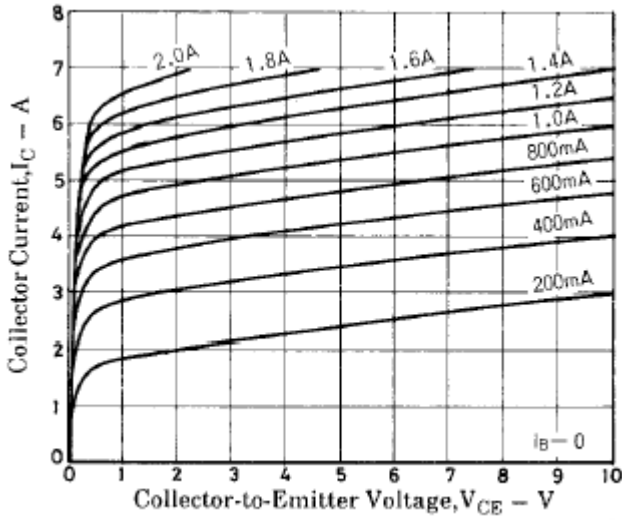

Fig.3 Static Characteristic

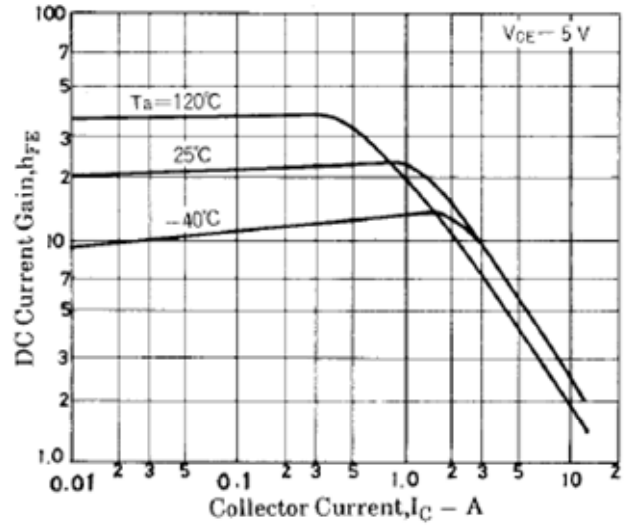

Fig.4 DC current Gain

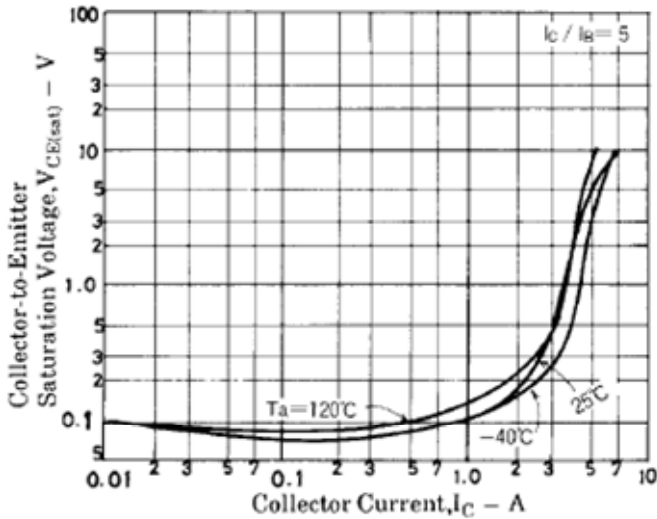

Fig.5 Collector-Emitter Saturation Voltage

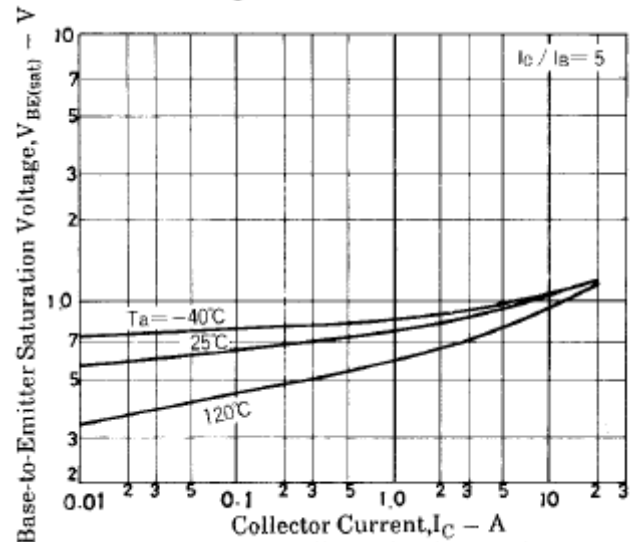

Fig.6 Base-Emitter Saturation Voltage

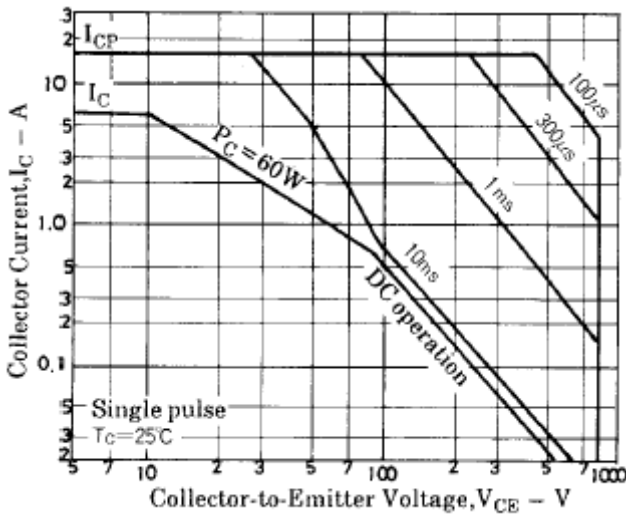

Fig.7 Safe Operating Area