

Multilayer Ferrite Beads

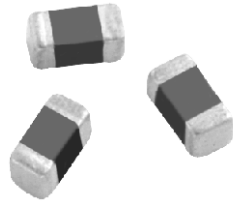

MECHANICAL SPECIFICATIONS

Solderability: 90 % coverage after 5 second dip in 235 °C solder following 60 second preheat at 120 °C to 150 °C and type R flux dip

Resistance To Solder Heat: 10 seconds in 260 °C solder after preheat and flux per above

Terminal Strength: 0.3 kilograms (0.66 pounds) minimum for 30 seconds

Beam Strength: 0.3 kilogram (0.66 pounds) minimum

FEATURES

- High reliability
- Surface mountable
- Magnetically self shielded
- Nickel barrier plating virtually eliminates silver migration
- 100 % lead (Pb)-free and RoHS compliant



RoHS
COMPLIANT

ENVIRONMENTAL SPECIFICATIONS

Operating Temperature: - 55 °C to + 125 °C

Thermal Shock: 100 cycles, - 40 °C to + 125 °C

Biased Humidity: 85 % RH at 85 °C, 1000 hours at full rated current

STANDARD ELECTRICAL SPECIFICATIONS		
Z at 100 MHz (± 25 %)	DCR MAX. (Ohms)	RATED DC CURRENT. (mA)
10	0.05	500
30	0.09	500
40	0.10	400
60	0.10	400
68	0.10	200
80	0.20	150
120	0.20	150
150	0.30	150
180	0.30	150
220	0.30	150
300	0.35	150
420	0.40	150
450	0.40	100
600	0.45	100
750	0.60	100
1000	0.60	100
1500	0.70	50
2000	0.80	50

PACKAGING OPTIONS
<ul style="list-style-type: none"> • Tape and Reel: Embossed plastic carrier tape Per EIA481-1 4000 pieces on a 7" [178 mm] reel

DIMENSIONS in inches [millimeters]			
A	B	C	D
0.063 ± 0.006 [1.6 ± 0.15]	0.032 ± 0.006 [0.8 ± 0.15]	0.014 ± 0.006 [0.36 ± 0.15]	0.032 ± 0.006 [0.8 ± 0.15]
E	F	G	H
0.102 [2.6]	0.031 [0.8]	0.023 [0.6]	0.039 [1.0]

DESCRIPTION				
ILBB-0603 MODEL	30 IMPEDANCE VALUE	± 25 % IMPEDANCE TOLERANCE	ER PACKAGE CODE	e3 JEDEC LEAD (Pb)-FREE STANDARD
GLOBAL PART NUMBER				
I L B B	0 6 0 3	E R	3 0 0	V
MODEL	SIZE	PACKAGE CODE	IMPEDANCE VALUE	IMPEDANCE TOLERANCE

TAPE AND REEL SPECIFICATIONS 0603 SIZE PER EIA-481-1 in inches [millimeters]

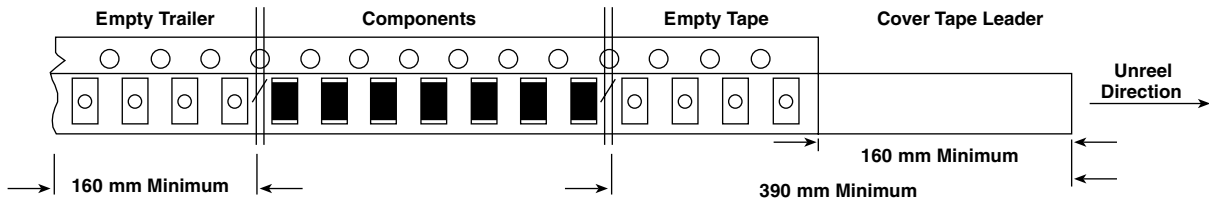
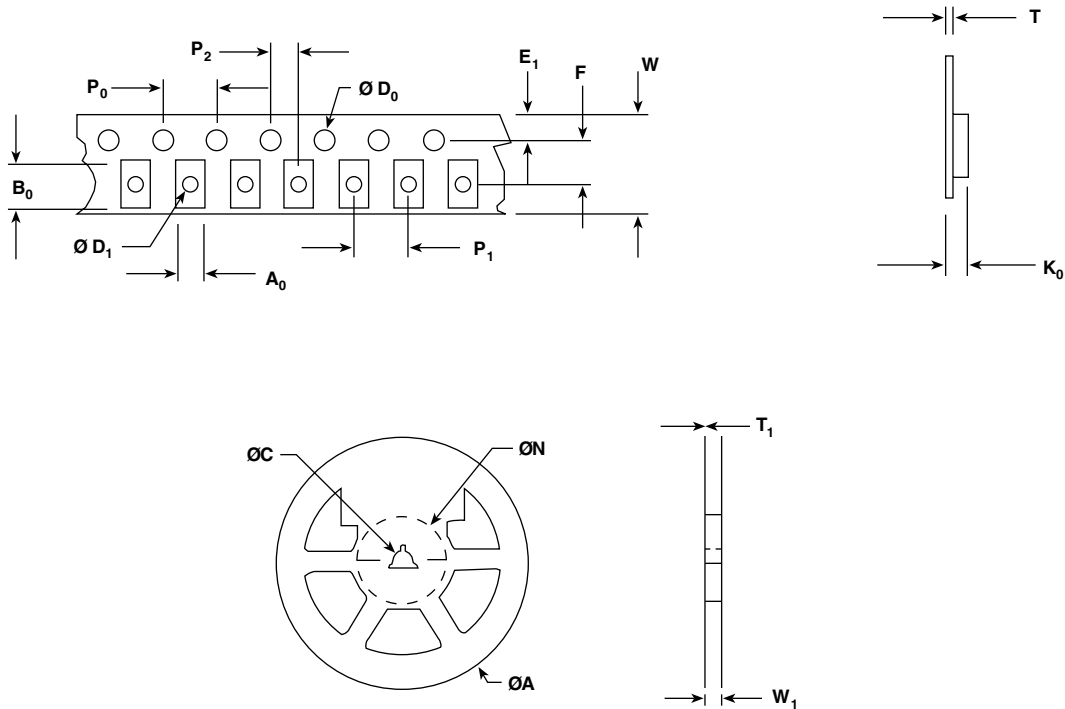

A₀	0.045 ± .004 [1.14 ± 0.1]	P₂	0.079 ± .002 [2.00 ± 0.05]
B₀	0.071 ± .008 [1.80 ± 0.2]	W	0.327 Max. [8.3 Max.]
D₀	0.059 + .004/- 0.000 [1.5 + 0.1]	T	0.008 ± .002 [0.2 ± 0.05]
D₁	0.039 Min. [1.0 Min.]	A	7.000 ± .079 [178.0 ± 2.0]
E₁	0.069 ± .004 [1.75 ± 0.1]	N	2.500 [63.5] Min.
F	0.138 ± .002 [3.50 ± 0.05]	C	0.51 + 0.02/- 0.008 [13 + 0.5]
K₀	0.045 ± .002 [1.15 ± 0.05]	W₁	0.315 + 0.059/- 0.00 [8.00 ± 1.50]
P₀	0.157 ± .004 [4.00 ± 0.1]	T₁	0.079 ± .002 [2.00 ± 0.05]
P₁	0.157 ± .004 [4.00 ± 0.1]		



TYPICAL CURVES - FREQUENCY CHARACTERISTICS OF R, X AND Z

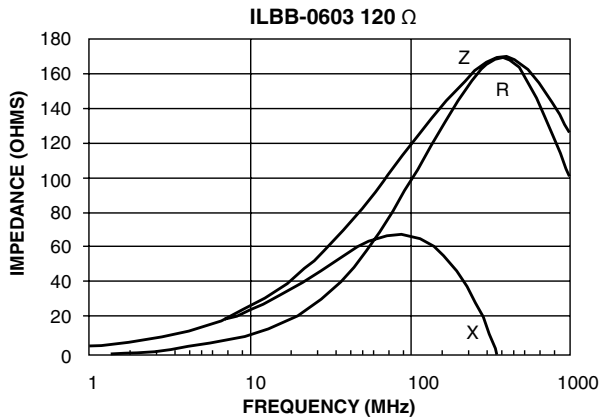
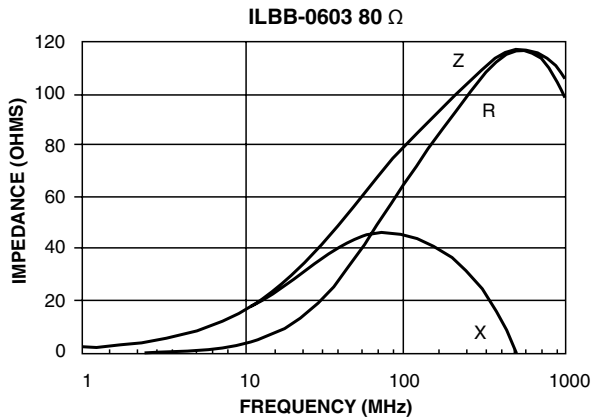
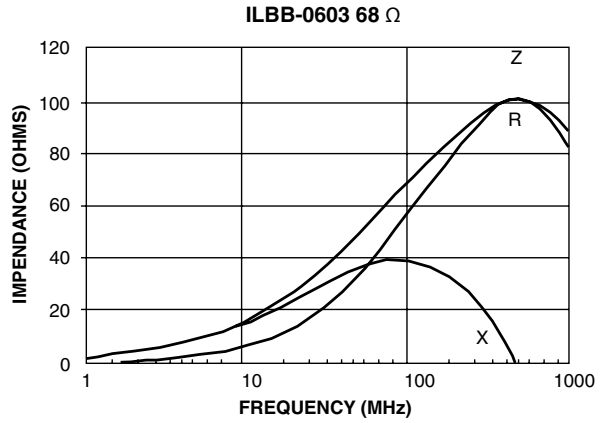
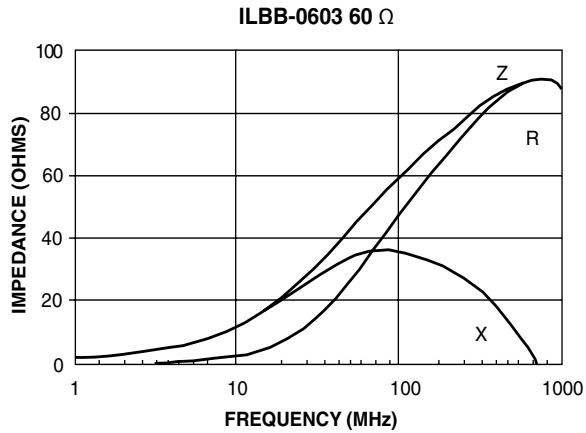
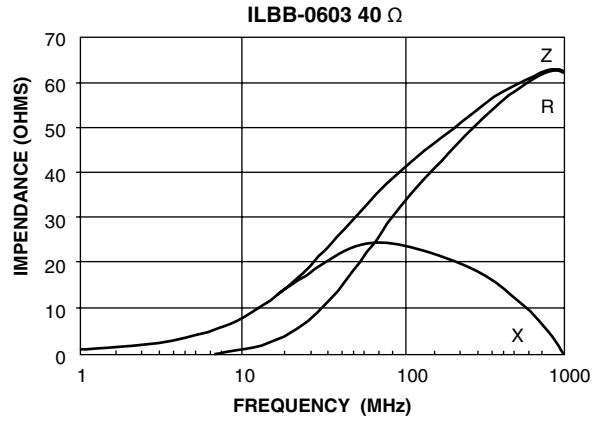
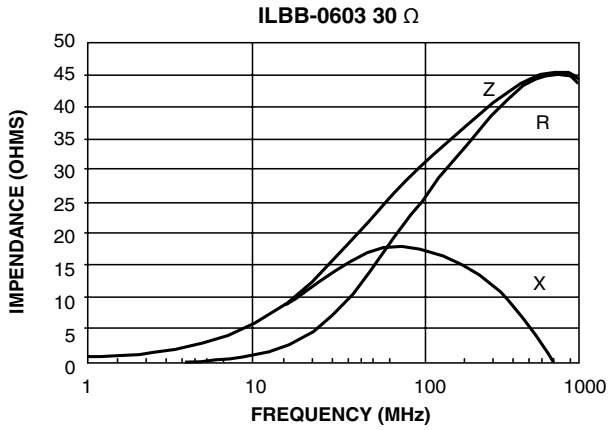

TYPICAL CURVES - FREQUENCY CHARACTERISTICS OF R, X AND Z

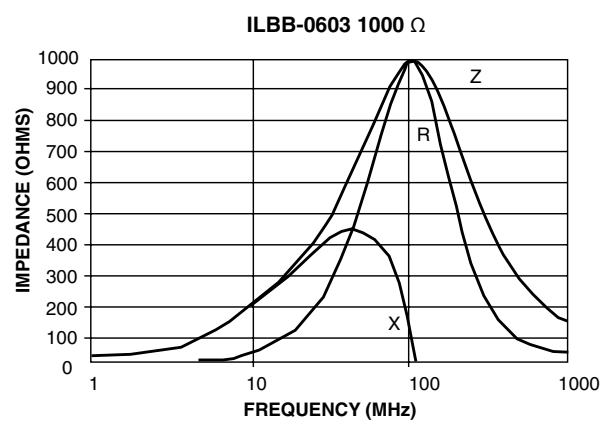
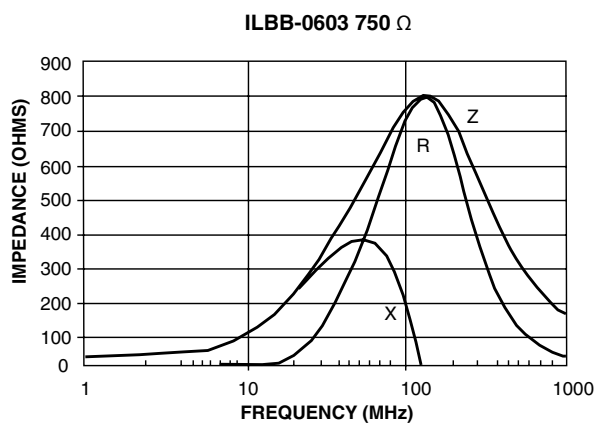
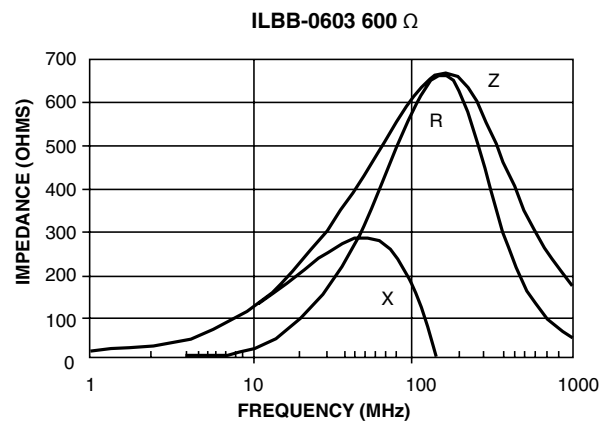
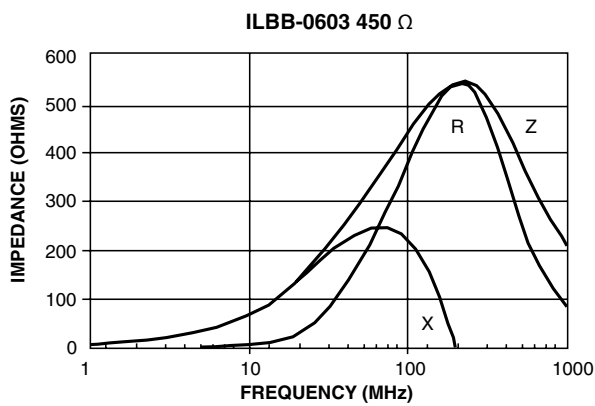
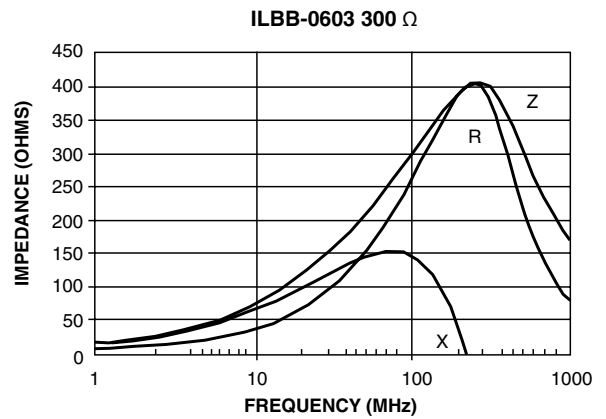
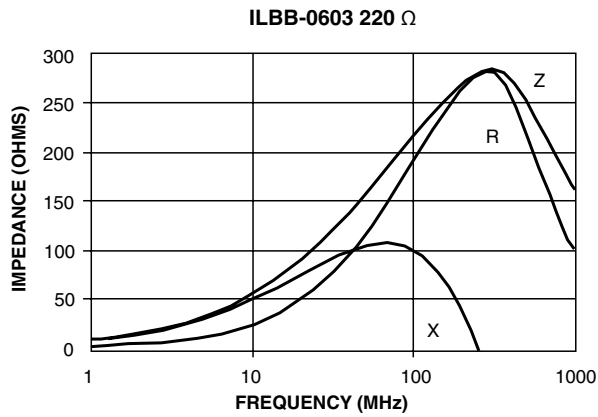



Notice

Specifications of the products displayed herein are subject to change without notice. Vishay Intertechnology, Inc., or anyone on its behalf, assumes no responsibility or liability for any errors or inaccuracies.

Information contained herein is intended to provide a product description only. No license, express or implied, by estoppel or otherwise, to any intellectual property rights is granted by this document. Except as provided in Vishay's terms and conditions of sale for such products, Vishay assumes no liability whatsoever, and disclaims any express or implied warranty, relating to sale and/or use of Vishay products including liability or warranties relating to fitness for a particular purpose, merchantability, or infringement of any patent, copyright, or other intellectual property right.

The products shown herein are not designed for use in medical, life-saving, or life-sustaining applications. Customers using or selling these products for use in such applications do so at their own risk and agree to fully indemnify Vishay for any damages resulting from such improper use or sale.