







SMT POWER INDUCTORS

Flat Coils - PG0155NL Series



-  All Inductors are RoHS Compliant
-  **Height:** 3.7mm Max
-  **Footprint:** 11.0mm x 10.4mm Max
-  **Current Rating:** up to 24A
-  **Inductance Range:** 0.30μH to 0.91μH
-  High temperature core material, no thermal aging below 150°C

Electrical Specifications @ 25°C — Operating Temperature -40°C to +130°C¹

Part Number	Inductance @ I _{rated} ² (μH TYP)	I _{rated} ³ (A)	DCR (mΩ)		Inductance @ 0A _{dc} (μH ±20%)	Saturation ⁴ Current I _{SAT} (A)	Heating ⁵ Current I _{dc} (A)	Core Loss ⁶ Factor (K2)
			TYP	MAX				
PG0155.331NL	0.30	24	1.7	2.2	0.33	38	24	81.36
PG0155.601NL	0.53	19	2.8	3.2	0.60	27	19	108.47
PG0155.102NL	0.91	14	5.3	5.8	1.0	21.5	14	142.73

Mechanical

Schematic

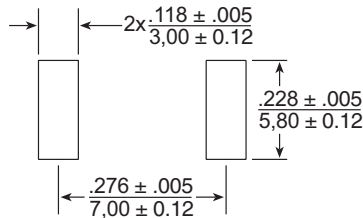
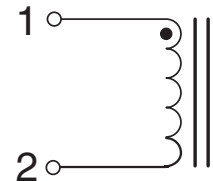
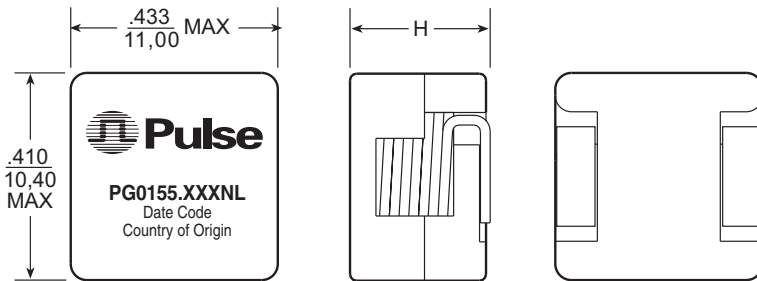

SUGGESTED PAD LAYOUT

Part No.	Max. Height "H" (in./mm)
PG0155.331NL	.146/3,7
PG0155.601NL	.146/3,7
PG0155.102NL	.142/3,6

Weight1.6 grams
Tape & Reel850/reel

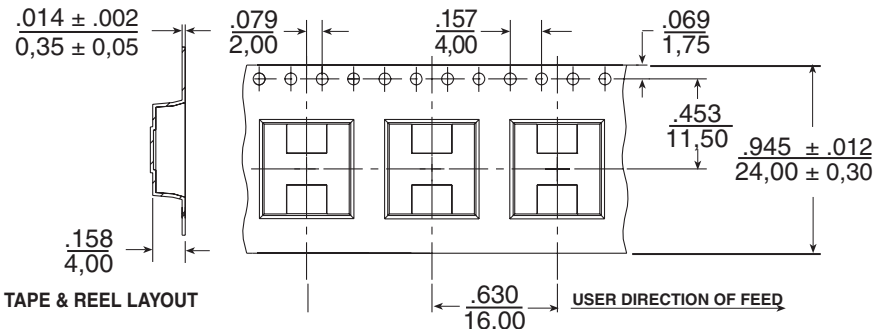

TAPE & REEL LAYOUT

Dimensions: Inches
mm
Unless otherwise specified,
all tolerances are ± .010
0,25

SMT POWER INDUCTORS

Flat Coils - PG0155NL Series



Notes from Tables

1. The temperature of the component (ambient plus temperature rise) must be within the standard operating temperature range.
2. Inductance at I_{rated} is a typical inductance value for the component taken at rated current.
3. The rated current listed is the lower of the saturation current @ 25°C or the heating current.
4. The saturation current, I_{sat} , is the current at which the component inductance drops by 20% (typical) at an ambient temperature of 25°C. This current is determined by placing the component in the specified ambient environment and applying a short duration pulse current (to eliminate self-heating effects) to the component.
5. The heating current, I_{DC} , is the DC current required to raise the component temperature by approximately 40°C. The heating current is determined by mounting the component on a typical PCB and applying current for 30 minutes. The temperature is measured by placing the thermocouple on top of the unit under

test. Take note that the component's performance varies depending on the system condition. It is suggested that the component be tested at the system level, to verify the temperature rise of the component during system operation.

6. Core loss approximation is based on published core data:

$$\text{Core Loss} = K1 * (f)^{1.30} * (K2\Delta I)^{2.41}$$

Where: Core Loss = in Watts

$$K1 = 1.20E-10$$

f = switching frequency in kHz

$K1$ & $K2$ = core loss factors

ΔI = delta I across the component in Ampere

$K2\Delta I$ = one half of the peak to peak flux density across the component in Gauss

7. Unless otherwise specified, all testing is made at 100kHz, 0.1V_{AC}.
8. Add suffix "T" to the part number for Tape & Reel packaging (ex: PG0155.331NLT).

Inductance vs Current Characteristics

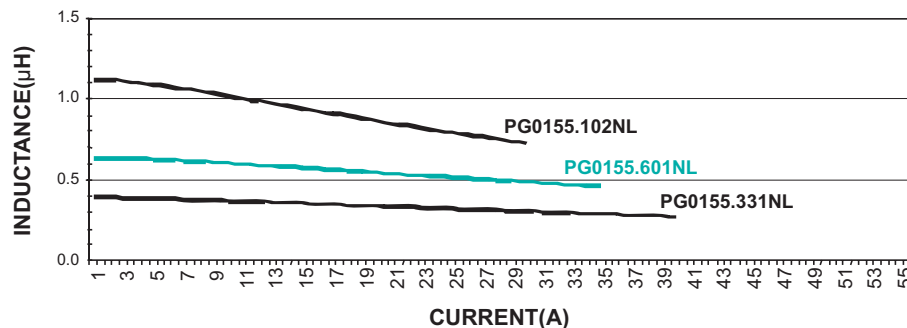

Typical Core Loss vs Peak Flux Density

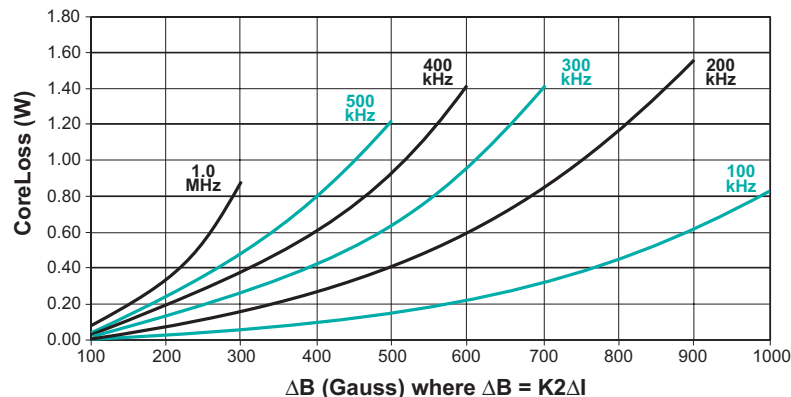

For More Information:

Pulse Worldwide Headquarters

12220 World Trade Dr.
San Diego, CA 92128
U.S.A.
www.pulseeng.com

Tel: 858 674 8100
Fax: 858 674 8262

Pulse Europe

Einsteinstrasse 1
D-71083 Herrenberg
Germany

Tel: 49 7032 7806 0
Fax: 49 7032 7806 12

Pulse China Headquarters

B402, Shenzhen
Tech-Innovation International
Tenth Kejian Rd.
High-Tech Industrial Park
Nanshan District, Shenzhen
China

Tel: 86 755 33966678
Fax: 86 755 33966700

Pulse North China

Room 1503
XinYin Building
No. 888 YiShan Rd.
Shanghai 200233
China

Tel: 86 21 54643211/2
Fax: 86 21 54643210

Pulse South Asia

150 Kampong Ampat
#07-01/02
KA Centre
Singapore 368324

Tel: 65 6287 8998
Fax: 65 6280 0080

Pulse North Asia

No. 26
Kao Ching Rd.
Yang Mei Chen
Tao Yuan Hsien
Taiwan, R. O. C.

Tel: 886 3 4641811
Fax: 886 3 4641911

Performance warranty of products offered on this data sheet is limited to the parameters specified. Data is subject to change without notice. Other brand and product names mentioned herein may be trademarks or registered trademarks of their respective owners. © Copyright, 2007. Pulse Engineering, Inc. All rights reserved.