

SEMiX 252GB126HD

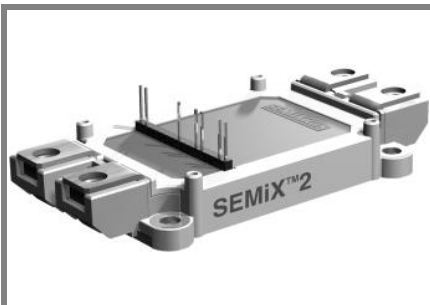

SEMiX[®] 2

Trench IGBT Modules

SEMiX 252GB126HD

Preliminary Data

Features

- Homogeneous Si
- Trench = Trenchgate technology
- $V_{CE(sat)}$ with positive temperature coefficient
- High short circuit capability

Typical Applications

- AC inverter drives
- UPS
- Electronic Welding

Remarks

- Case temperatur limited to $T_C=125^\circ\text{C}$ max.
- Not for new design

Absolute Maximum Ratings		$T_{case} = 25^\circ\text{C}$, unless otherwise specified		
Symbol	Conditions	Values		Units
IGBT				
V_{CES}	$T_j = 25^\circ\text{C}$	1200		V
I_C	$T_j = 150^\circ\text{C}$	$T_c = 25^\circ\text{C}$	240	A
		$T_c = 80^\circ\text{C}$	170	A
I_{CRM}	$I_{CRM} = 2 \times I_{Cnom}$	300		A
V_{GES}		± 20		V
t_{psc}	$V_{CC} = 600\text{ V}; V_{GE} \leq 20\text{ V}; T_j = 125^\circ\text{C}$ $V_{CES} < 1200\text{ V}$	10		μs
Inverse Diode				
I_F	$T_j = 150^\circ\text{C}$	$T_c = 25^\circ\text{C}$	225	A
		$T_c = 80^\circ\text{C}$	155	A
I_{FRM}	$I_{FRM} = 2 \times I_{Fnom}$	300		A
I_{FSM}	$t_p = 10\text{ ms}; \text{sin.}$	$T_j = 25^\circ\text{C}$	1000	A
Module				
$I_{t(RMS)}$		600		A
T_{vj}		- 40 ... + 150		$^\circ\text{C}$
T_{stg}		- 40 ... + 125		$^\circ\text{C}$
V_{isol}	AC, 1 min.	4000		V

Characteristics		$T_{case} = 25^\circ\text{C}$, unless otherwise specified			
Symbol	Conditions	min.	typ.	max.	Units
IGBT					
$V_{GE(th)}$	$V_{GE} = V_{CE}, I_C = 6\text{ mA}$	5	5,8	6,5	V
I_{CES}	$V_{GE} = 0\text{ V}, V_{CE} = V_{CES}$			0,3	mA
V_{CE0}		$T_j = 25^\circ\text{C}$	1	1,2	V
		$T_j = 125^\circ\text{C}$	0,9	1,1	V
r_{CE}	$V_{GE} = 15\text{ V}$	$T_j = 25^\circ\text{C}$	4,7	6,3	$\text{m}\Omega$
		$T_j = 125^\circ\text{C}$	7,3	9	$\text{m}\Omega$
$V_{CE(sat)}$	$I_{Cnom} = 150\text{ A}, V_{GE} = 15\text{ V}$	$T_j = 25^\circ\text{C}_{chiplev.}$	1,7	2,15	V
		$T_j = 125^\circ\text{C}_{chiplev.}$	2	2,45	V
C_{res}	$V_{CE} = 25, V_{GE} = 0\text{ V}$	$f = 1\text{ MHz}$	10,7		nF
C_{oes}			0,6		nF
C_{res}			0,5		nF
Q_G	$V_{GE} = -8 \dots +15\text{V}$	1200		nC	
$t_{d(on)}$	$R_{Gon} = 3\ \Omega$	$V_{CC} = 600\text{V}$ $I_{Cnom} = 150\text{A}$	300		ns
t_r			45		ns
E_{on}	$R_{Goff} = 3\ \Omega$	$T_j = 125^\circ\text{C}$	20		mJ
$t_{d(off)}$			570		ns
t_f			110		ns
E_{off}			21		mJ
$R_{th(j-c)}$	per IGBT			0,15	K/W

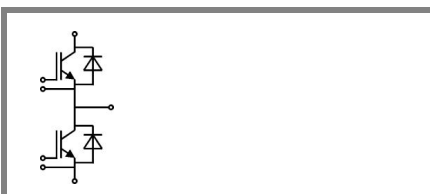

GB

SEMiX 252GB126HD

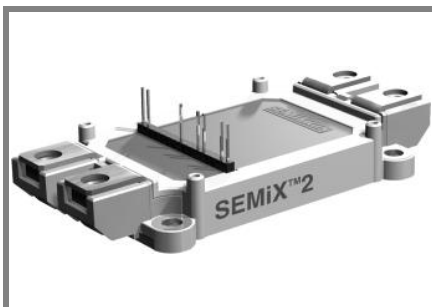

SEMiX[®] 2

Trench IGBT Modules

SEMiX 252GB126HD

Preliminary Data

Features

- Homogeneous Si
- Trench = Trenchgate technology
- $V_{CE(sat)}$ with positive temperature coefficient
- High short circuit capability

Typical Applications

- AC inverter drives
- UPS
- Electronic Welding

Remarks

- Case temperatur limited to $T_C=125^{\circ}\text{C}$ max.
- Not for new design



GB

Characteristics		min.	typ.	max.	Units
Symbol	Conditions				
Inverse Diode					
$V_F = V_{EC}$	$I_{Fnom} = 150 \text{ A}; V_{GE} = 0 \text{ V}$		1,6	1,8	V
			1,6	1,8	V
					V
V_{F0}			1	1,1	V
			0,8	0,9	V
r_F			4	4,7	mΩ
			5,3	6	mΩ
I_{RRM}	$I_{Fnom} = 150 \text{ A}$		260		A
Q_{rr}	$di/dt = 4600 \text{ A}/\mu\text{s}$		43		μC
E_{rr}	$V_{GE} = -15 \text{ V}; V_{CC} = 600 \text{ V}$		18		mJ
$R_{th(j-c)D}$	per diode			0,24	K/W
Module					
L_{CE}			18		nH
$R_{CC'+EE'}$	res., terminal-chip	$T_{case} = 25^{\circ}\text{C}$	0,7		mΩ
		$T_{case} = 125^{\circ}\text{C}$	1		mΩ
$R_{th(c-s)}$	per module		0,045		K/W
M_s	to heat sink (M5)		3	5	Nm
M_t	to terminals (M6)		2,5	5	Nm
w				250	g
Temperature sensor					
R_{100}	$T_c = 100^{\circ}\text{C}$ ($R_{25} = 5 \text{ k}\Omega$)		0,493±5%		kΩ
$B_{100/125}$	$R(T) = R_{100} \exp[B_{100/125} (1/T - 1/T_{100})]$; $T[\text{K}]; B$		3550±2%		K

This is an electrostatic discharge sensitive device (ESDS), international standard IEC 60747-1, Chapter IX.

This technical information specifies semiconductor devices but promises no characteristics. No warranty or guarantee expressed or implied is made regarding delivery, performance or suitability.

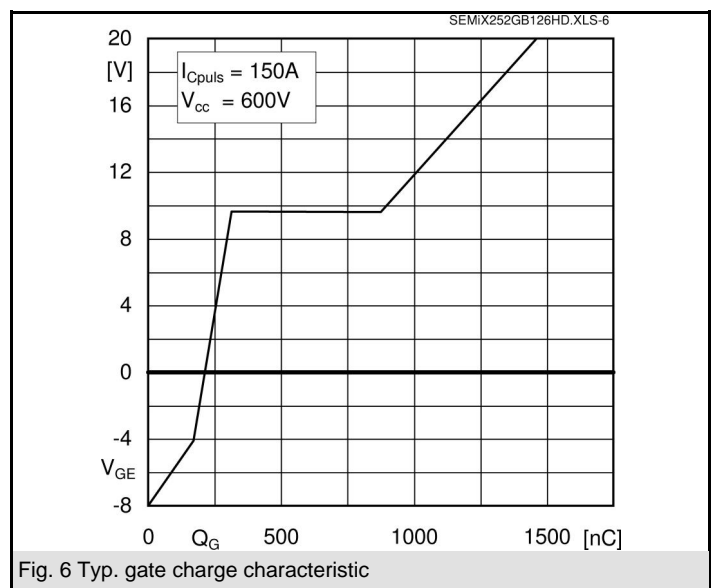
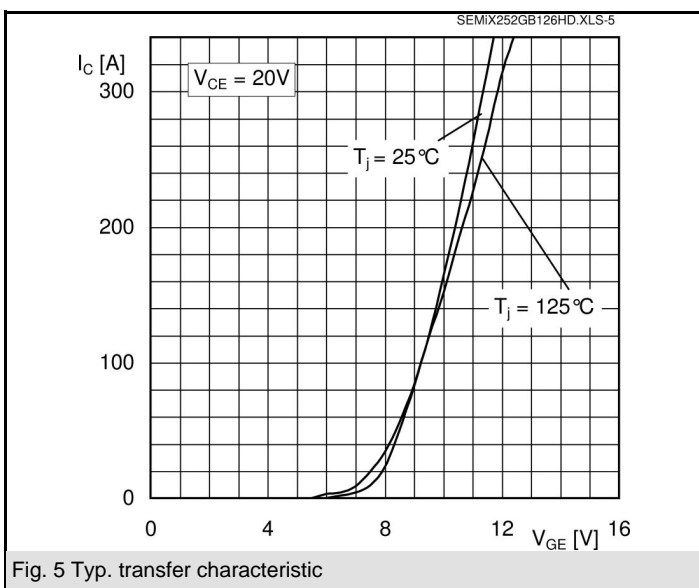
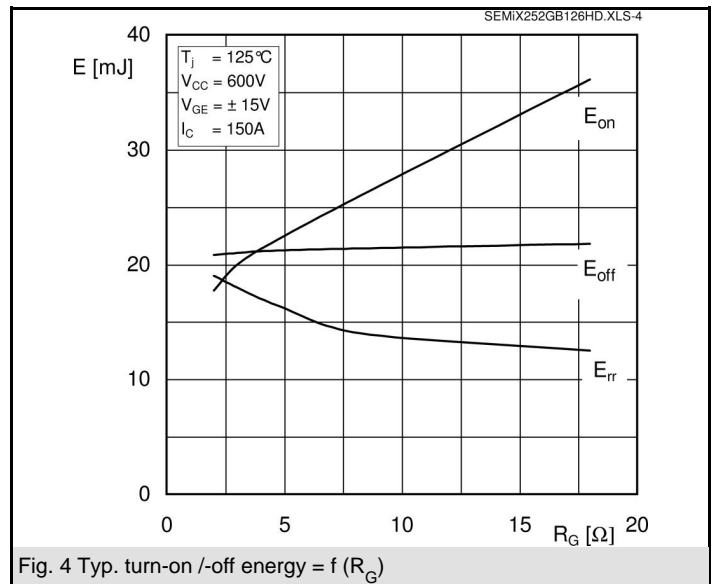
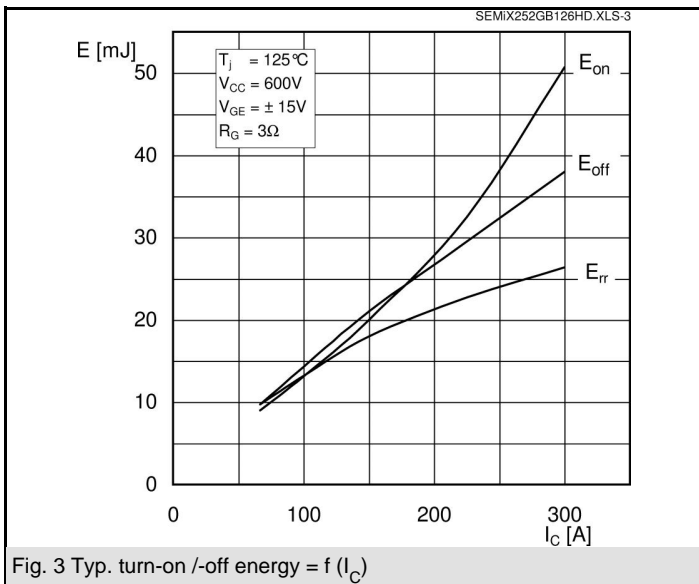
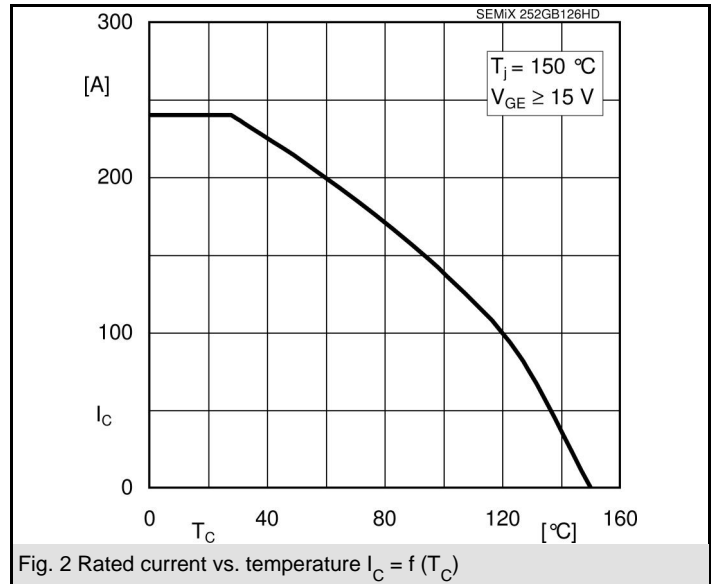
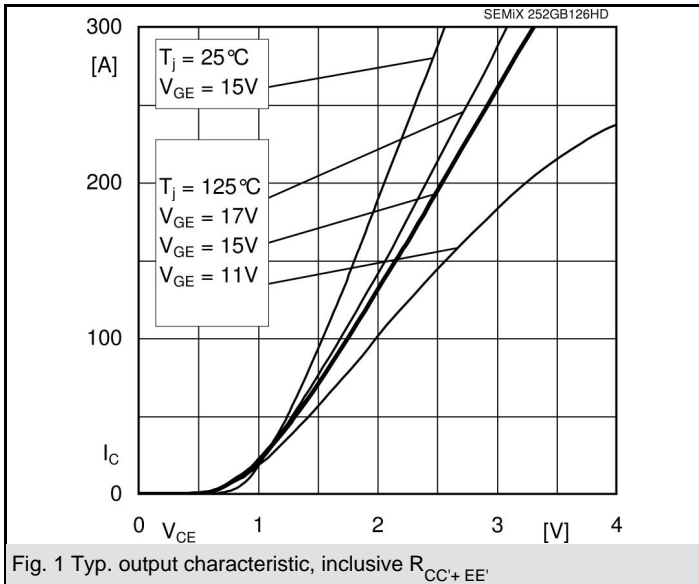

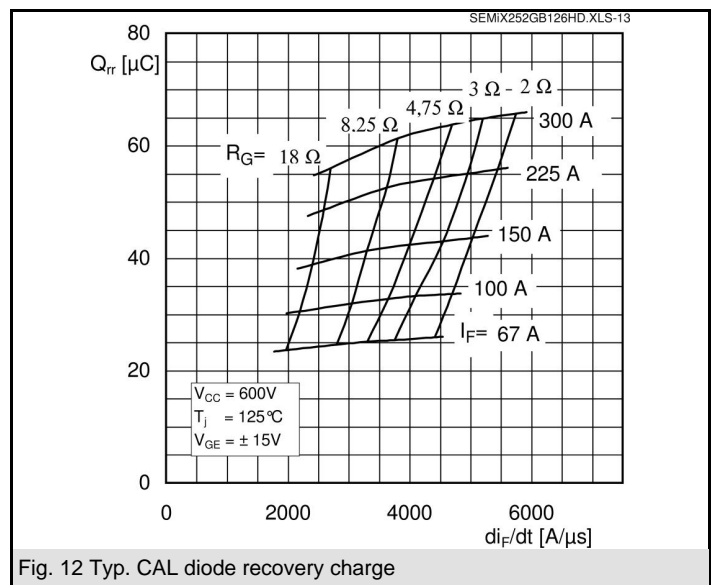
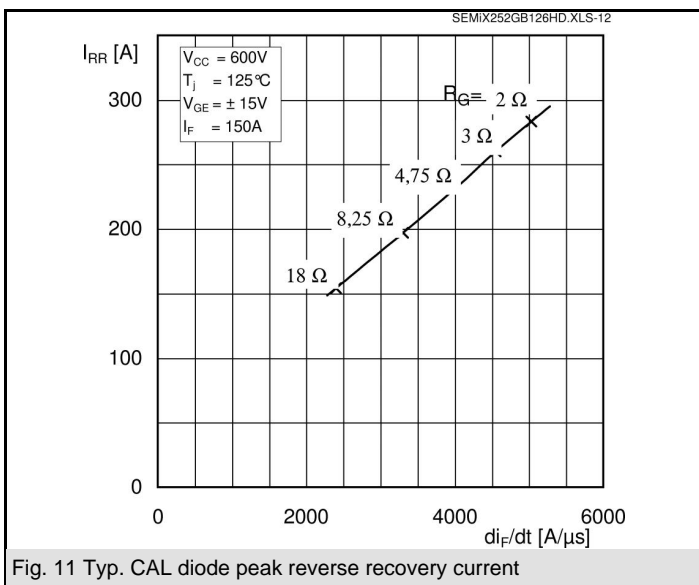
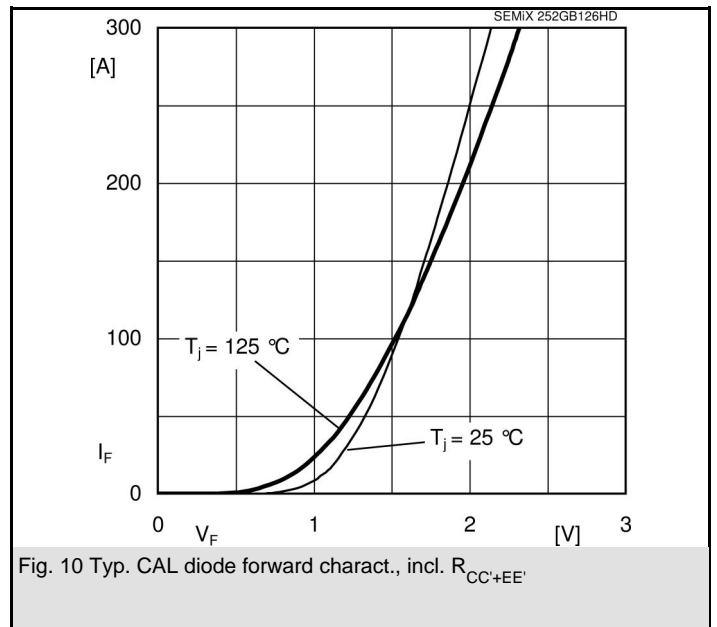
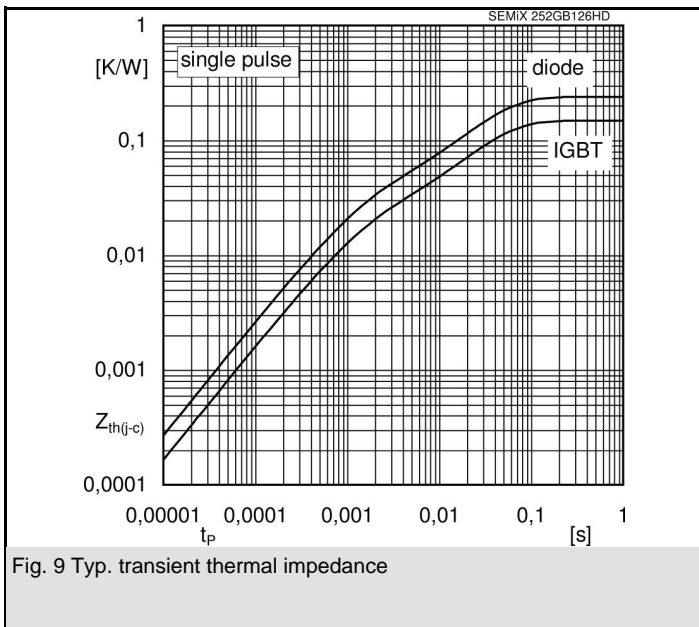
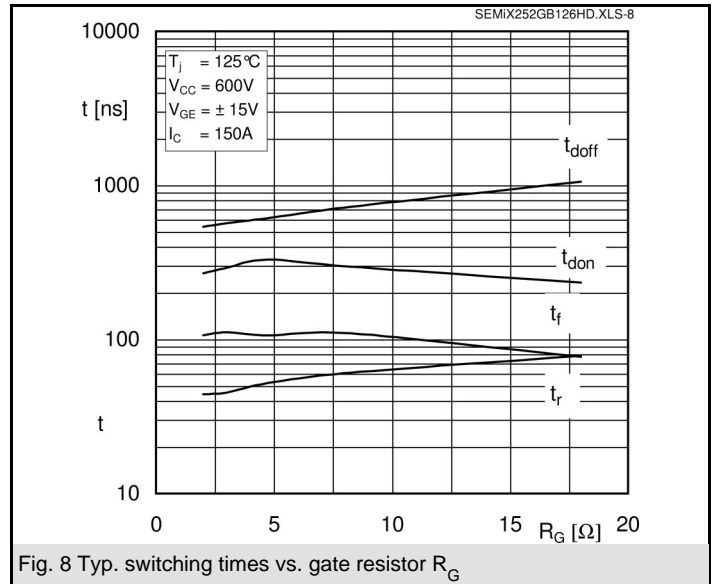
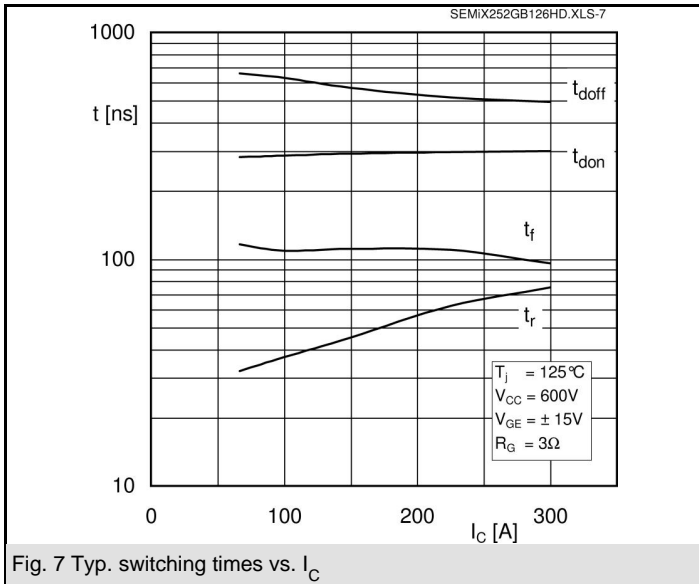

SEMiX 252GB126HD

case: SEMiX 2

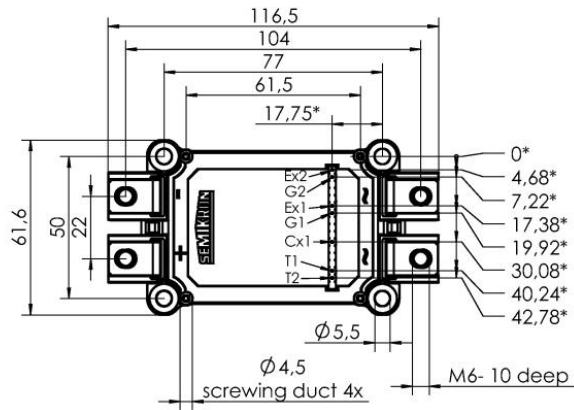
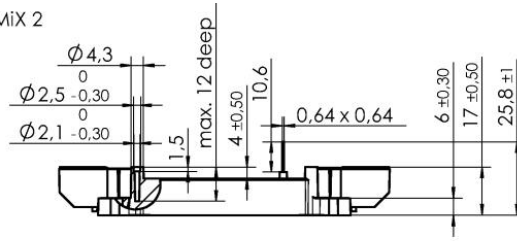

*= all measures with $\phi 0,5$

Case SEMiX 2

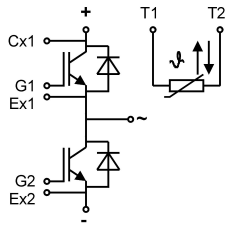

Pinout

GB