



**RIC7113**

**Total Ionizing Dose Test Report**

**May 2000**

Addendum to RIC7113 Total Ionizing Dose Test Report dated May 2000

December 28, 2001

Wafer traceability is not clear. The following table indicates the connection between the serial numbers and the wafers tested.

<b>Wafer Number</b>	<b>Serial Numbers</b>
2	1 thru 8
6	9 thru 18
8	19 thru 27
10	28 thru 37
14	38 thru 47
17	48 thru 56
20	57 thru 63
23	64 thru 73

The last table identifies where each serial number was used:

<b>Wafer Number</b>	<b>Dynamic Test</b>	<b>Static Test</b>	<b>500krad</b>	<b>Serial Numbers Not Used</b>
2	8	3, 4, 5, 6	2	1, 7
6	15	12, 16, 17, 18	11	9, 10, 13, 14
8	20, 25	21, 22, 26, 27	None	19, 23, 24
10	30, 33	34, 35, 36, 37	31	28, 29, 32
14	40, 41	44, 45, 46, 47	39, 43	38, 42
17	53	50, 51, 52, 54	48, 56	49, 55
20	63	58, 59, 60, 61	None	57, 62
23	65, 66	68, 69, 70, 73	71	64, 67, 72

The data above may be used to navigate thru the test report, which did not make consistent use of the serial numbers. The serial numbers are shown at the top row of each column in the test data (Appendix B and C). In some cases the serial number is shown alone and in other cases the wafer number is indicated as a dash number.

**INTERNATIONAL RECTIFIER  
EL SEGUNDO, CALIFORNIA**

**Radiation Testing**

The RIC7113 has been tested in accordance with MIL-STD-883 test method 1019, condition A. Raytheon Corp. in El Segundo, CA has been contracted to perform the irradiation and supply the device bias during irradiation. The Defense Supply Center Columbus (DSCC) has granted Raytheon test lab suitability for this test method performed at the El Segundo site. All other tests including burn-in, electrical performance and aging are performed at International Rectifier Corp. in El Segundo, CA. The test plan for conducting the radiation testing is included in Appendix A, herein.

Radiation testing is comprised of two electrical bias conditions – static and dynamic. Static bias is performed on a sample of assembled devices from all wafers considered for production. Dynamic bias is performed on a small sample of assembled devices as a one-time qualification test. Schematics of static and dynamic bias circuits are shown in Figures 1 and 2, respectively.

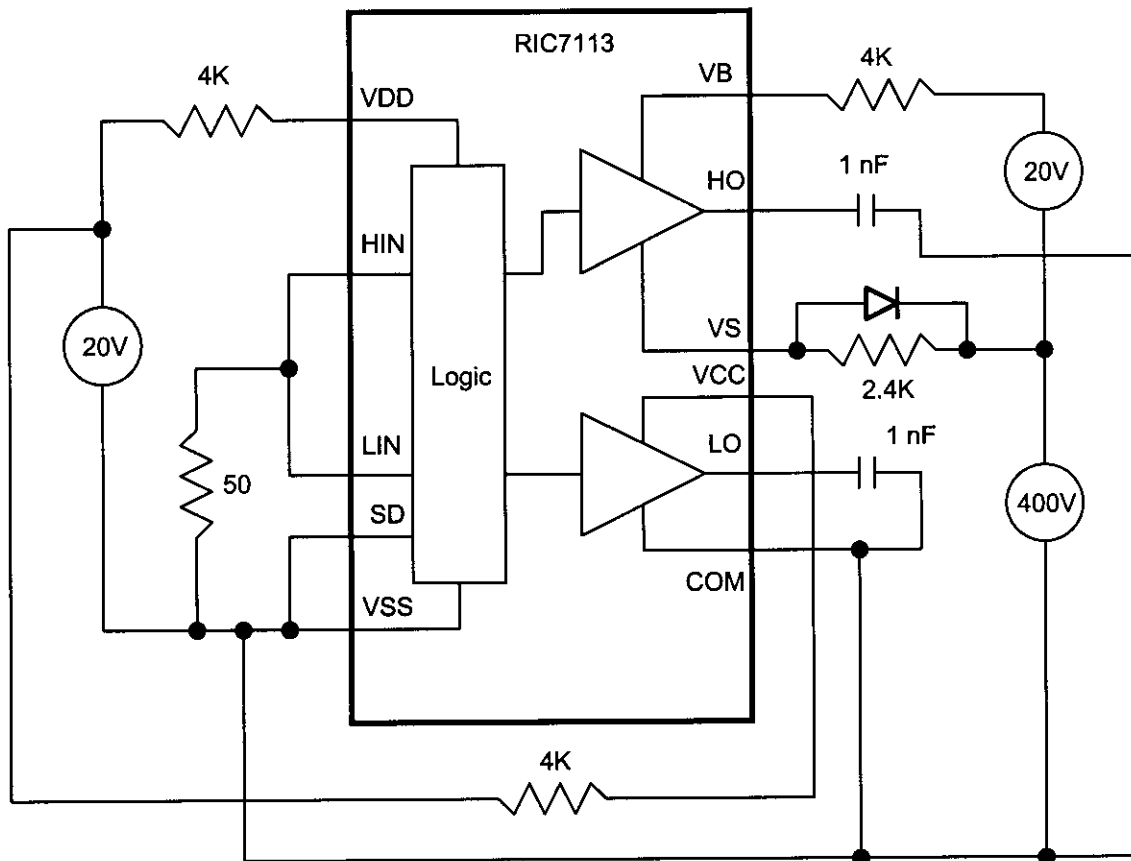

**Figure 1 – Static Bias Circuit**

INTERNATIONAL RECTIFIER  
EL SEGUNDO, CALIFORNIA

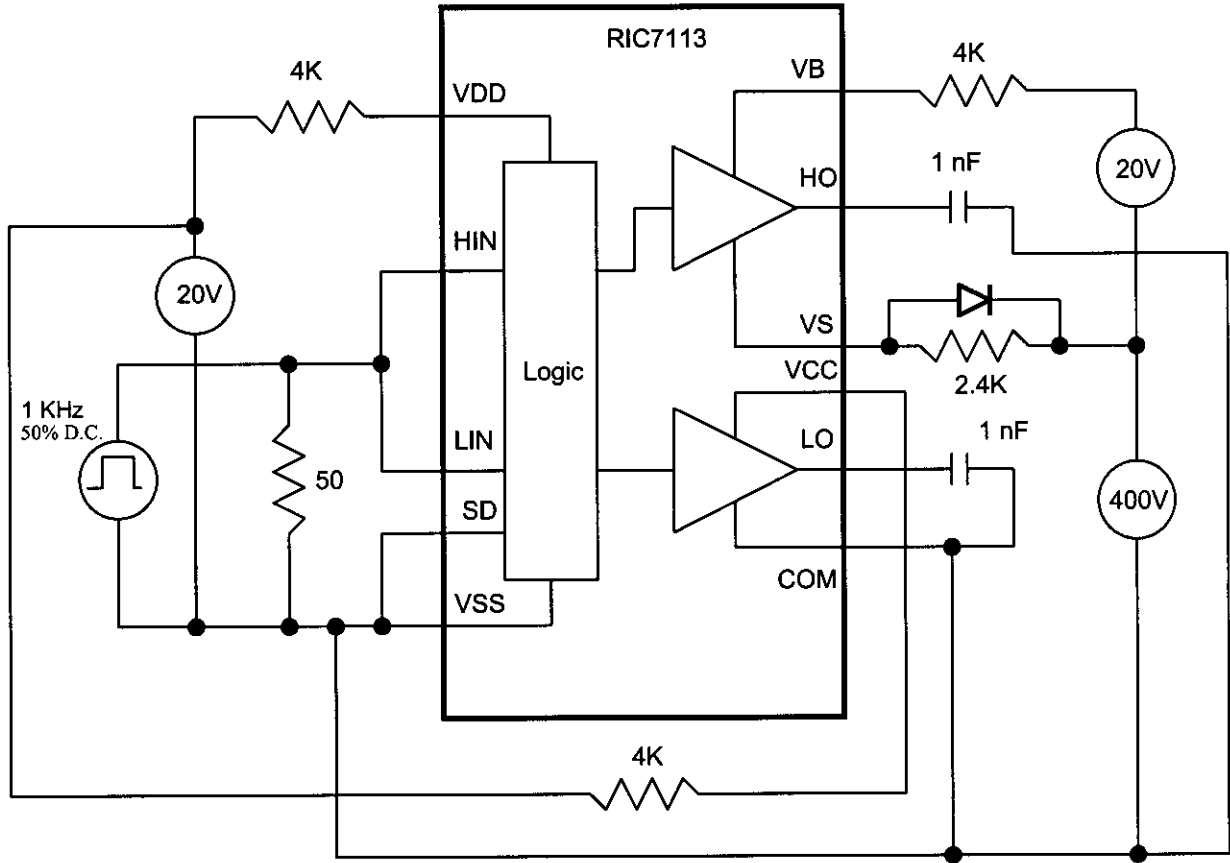

Figure 2 – Dynamic Bias Circuit

Test Results

The electrical test results are provided in Appendix B, herein. All devices tested were within specification limits immediately following the irradiation. Following the accelerated aging, again all devices tested were within specification limits. The mean values of key parameters are shown in Table 1 below for each test point. Much of this data is shown graphically in figures 3 thru 14 below. One device S/N 8, failed the initial electrical test but was not noticed until further testing was completed. Subsequent electrical testing of S/N 8 did not indicate any problem, thus it was concluded that the initial data was incorrect.

Eight additional devices were irradiated to a 500Krad (Si) level. Four of the devices (S/N's 2, 11, 31, 39) were dynamically biased and four (S/N's 43, 48, 56, 71) were statically biased. All eight devices failed. The four dynamically biased devices failed functionally. The four statically biased devices failed parametric limits only. The electrical data following the irradiation is shown in Appendix C.

**INTERNATIONAL RECTIFIER  
EL SEGUNDO, CALIFORNIA**

**Table 1 - Mean Parameters per Test Point**

Parameter	Initial	Post BI	Post 150K Dynamic Bias	Post 150K Static Bias	Post Aging Dynamic Bias	Post Aging Static Bias	Units
IQDD0	0.039	0.037	0.803	0.041	0.038	0.034	uA
IQCC0	94.47	94.35	90.03	90.08	86.04	85.86	uA
IQBS0	73.77	73.88	71.75	71.3	68.94	68.73	uA
IHIN0	0.013	0.013	0.013	0.013	0.013	0.013	uA
ILIN0	0.013	0.013	0.013	0.013	0.013	0.013	uA
ISD0	0.012	0.013	0.013	0.013	0.013	0.013	uA
IQDD1	0.058	0.065	0.698	0.054	0.137	0.047	uA
IQCC1	102.78	102.58	100.53	97.36	94.19	93.97	uA
IQBS1	57.36	57.5	54.78	54.67	52.38	52.35	uA
IHIN1	24.22	24.28	23.6	23.88	24.34	24.16	uA
ILIN1	24.56	24.56	23.73	24.15	24.53	24.45	uA
ISD1	24.22	24.27	23.48	23.89	24.27	24.16	uA
VTH+HS	8.43	8.39	7.95	8.13	7.93	8.13	V
VTH-HS	6.92	6.85	6.27	6.62	6.22	6.54	V
VTH+LS	8.37	8.36	7.94	8.13	7.91	8.13	V
VTH-LS	6.83	6.81	6.23	6.57	6.19	6.5	V
VTH+SD	8.38	8.36	8.27	8.13	8.33	8.13	V
VCCUV+PA	8.35	8.51	8.46	8.59	9.23	9.23	V
VCCUV-PA	8.11	8.26	8.19	8.32	8.94	8.96	V
VBSUV+PA	8.42	8.56	8.58	8.56	8.3	8.29	V
VBSUV-PA	8.17	8.29	8.3	8.28	8.05	8.04	V

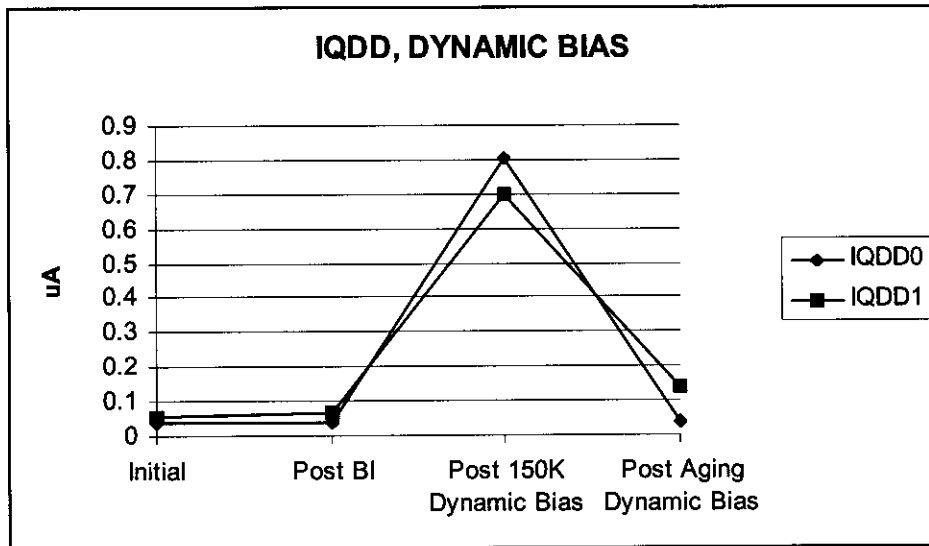

Figure 3

INTERNATIONAL RECTIFIER  
EL SEGUNDO, CALIFORNIA

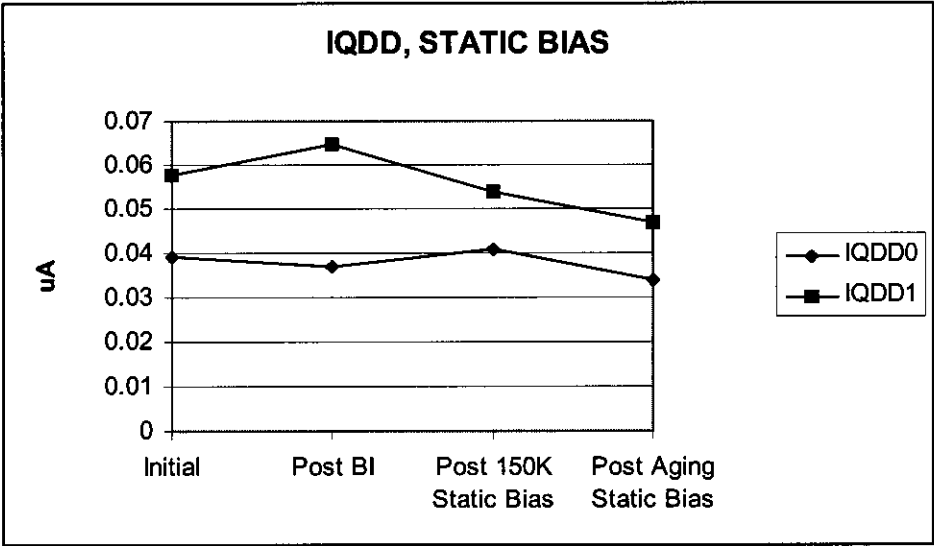

Figure 4

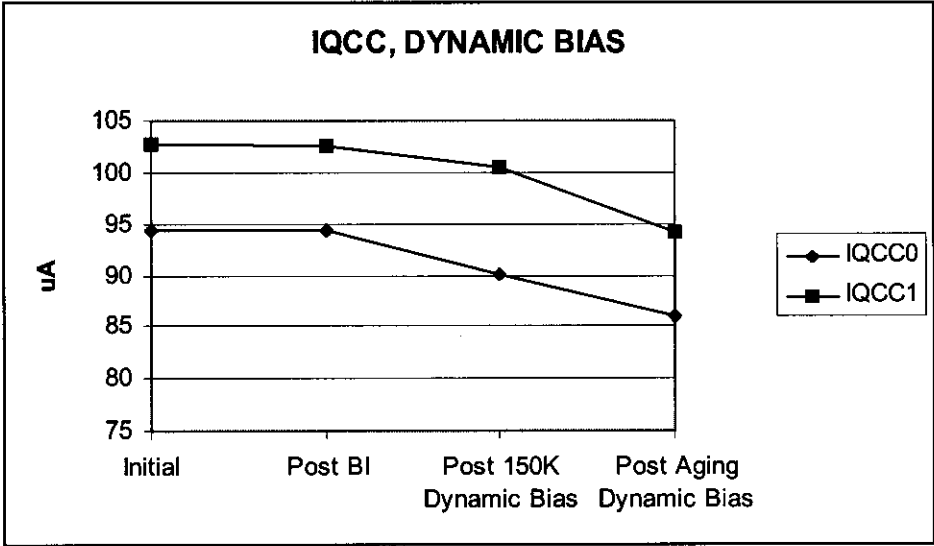

Figure 5

INTERNATIONAL RECTIFIER  
EL SEGUNDO, CALIFORNIA

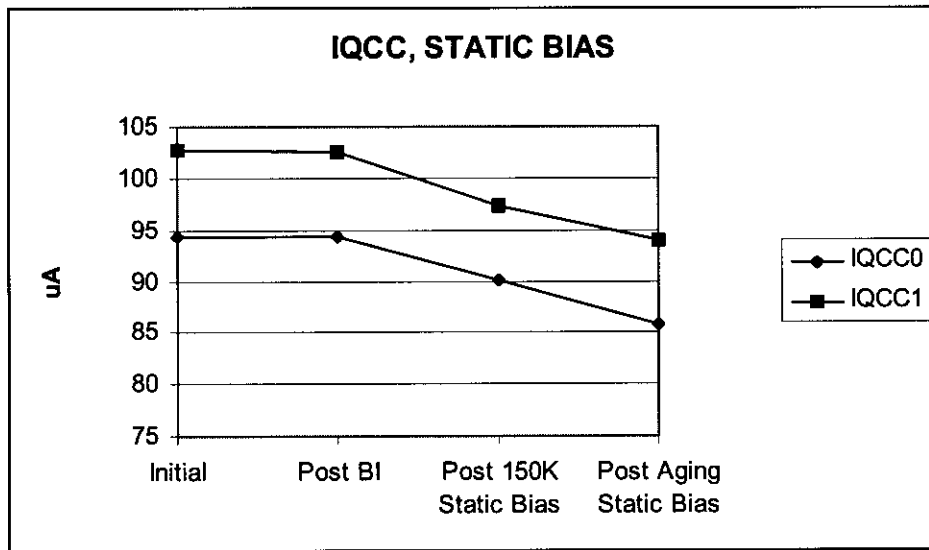

Figure 6

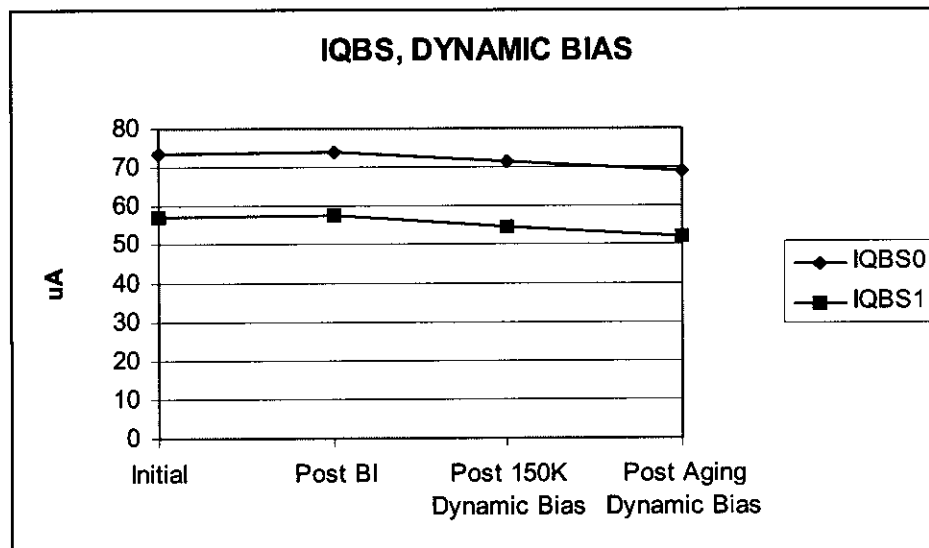

Figure 7

INTERNATIONAL RECTIFIER  
EL SEGUNDO, CALIFORNIA

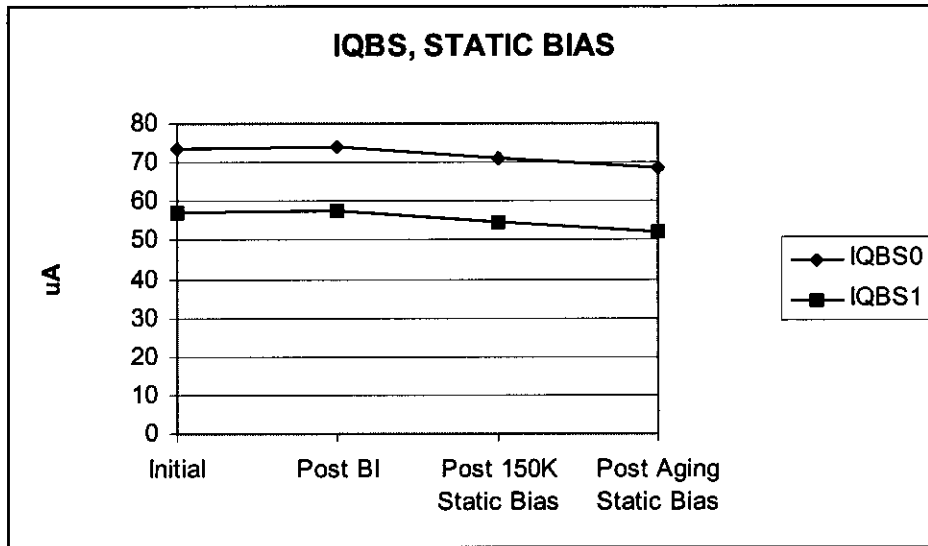

Figure 8

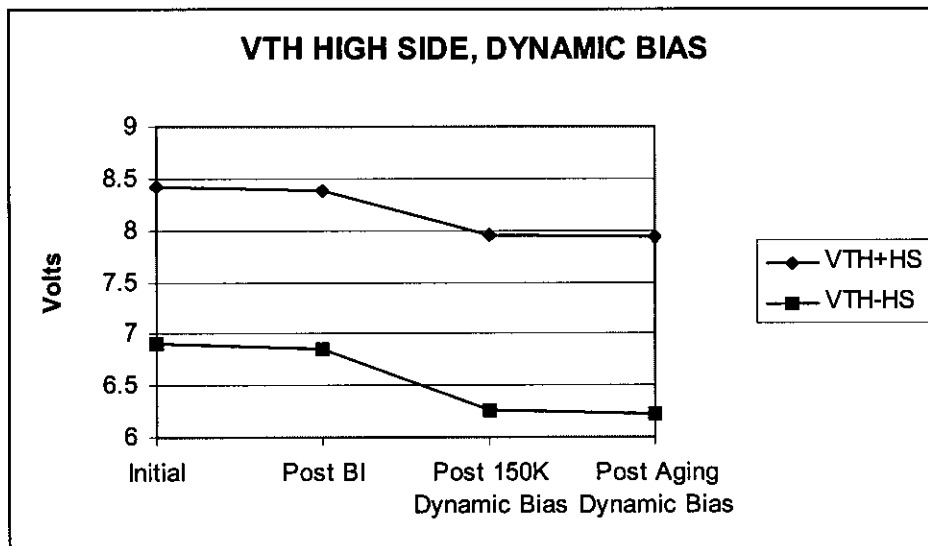

Figure 9



INTERNATIONAL RECTIFIER  
EL SEGUNDO, CALIFORNIA

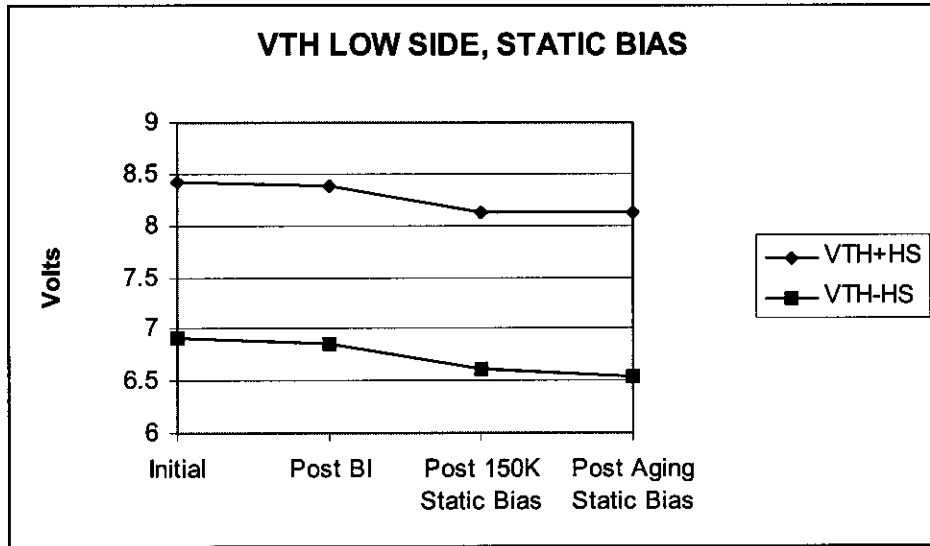

Figure 10

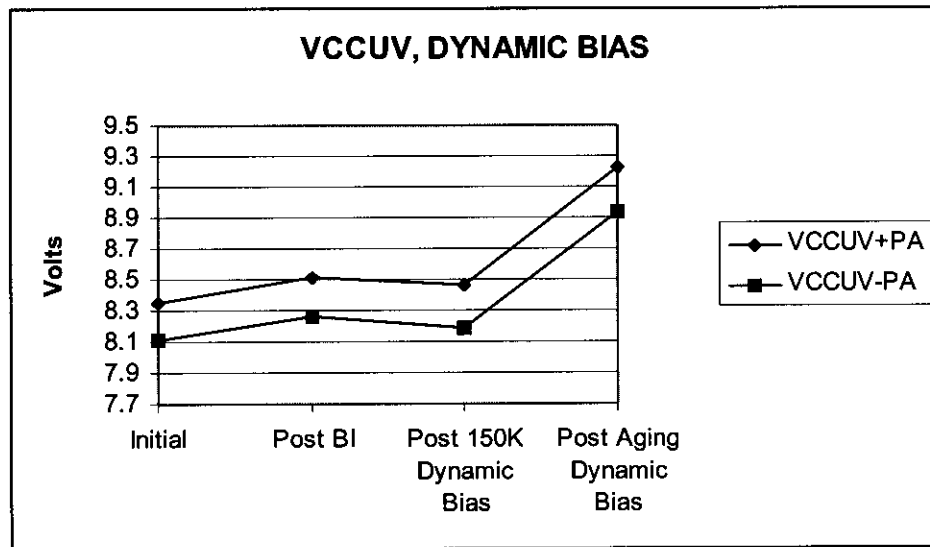

Figure 11

INTERNATIONAL RECTIFIER  
EL SEGUNDO, CALIFORNIA

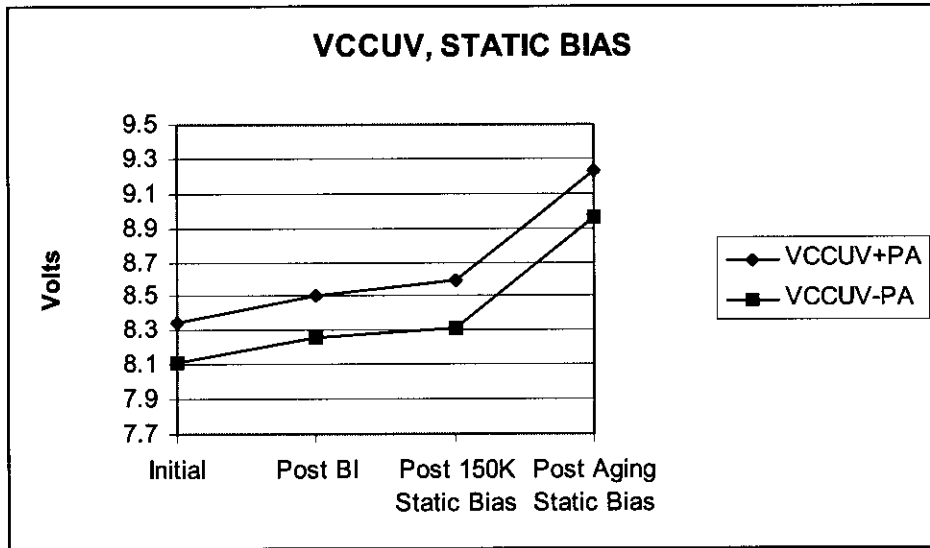

Figure 12

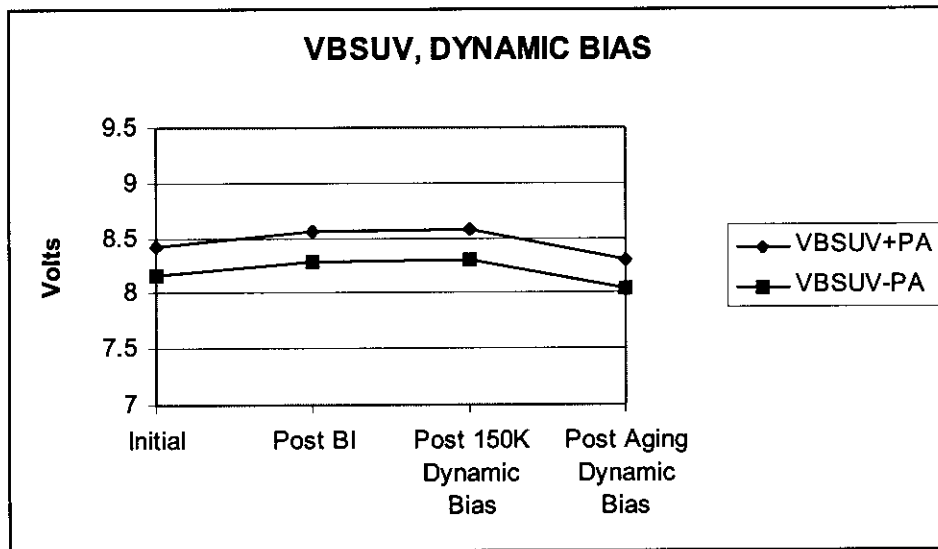

Figure 13

INTERNATIONAL RECTIFIER  
EL SEGUNDO, CALIFORNIA

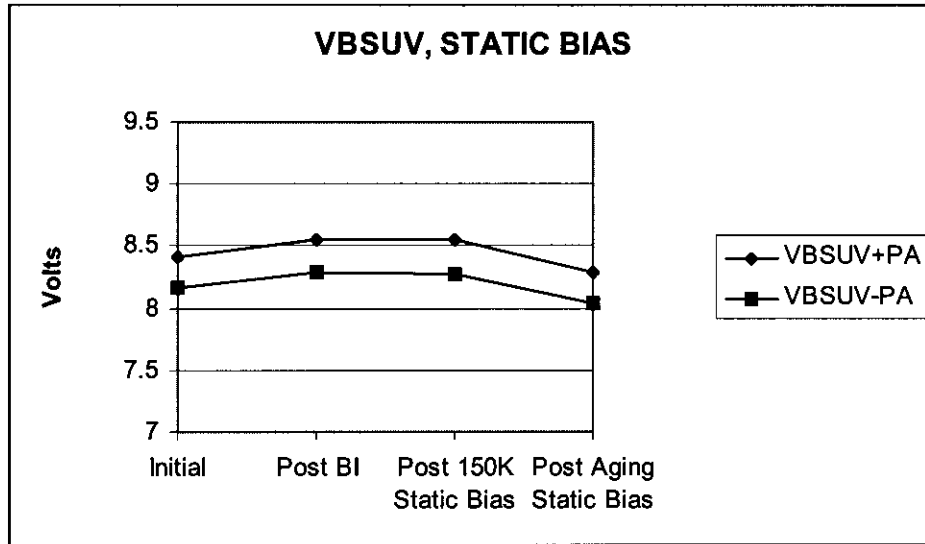

Figure 14

Conclusion

Wafer lot 800819 has demonstrated radiation hardness against ionizing radiation. The parametric stability of the device is excellent as measured in accordance with MIL-STD-883 test method 1019, condition A.

The post-irradiation limits may be set equal to the pre-irradiation limits, as very little variation was noted.

The device is not suitable for an irradiation environment in excess of 333Krad(Si) as determined by evaluation of 8 samples tested to 500Krad(Si) (1.5X). Further evaluation is needed to more fully characterize the performance versus irradiation.

INTERNATIONAL RECTIFIER  
EL SEGUNDO, CALIFORNIA

# Appendix A

## Test Plan

**INTERNATIONAL RECTIFIER  
EL SEGUNDO, CALIFORNIA**

TABLE 6

GROUP E INSPECTON  
SUBGROUP 2

TOTAL DOSE, STATIC BIAS, CONDITION B

PERFORM THIS SUBGROUP ON EACH WAFER IN EACH INSPECTION LOT

LOT SAMPLE = 4 DEVICES/WAFER (PLUS 2 CORRELATION SAMPLES)  
0 FAIL

	TEST AND METHOD	CONDITIONS AND NOTES
1.	PRE-IRRADIATION ELECTS 71-3539	SEE PRE RAD ELECTRICAL MEASUREMENTS USE TEST PROGRAM - 70-8371

TESTED:	6		TESTED BY:	SEE DATA
PASSED:	6		DATE:	SEE DATA
FAILED:	0		EQUIPMENT ID:	SEE DATA

2.	BURN-IN  71-9902 MIL-STD-883 TM1005, COND. A	VDD = VCC = VB = 20V      VS = 400V HIN = LIN = SD = VSS = COM = 0V ALL VOLTAGES SHALL BE WITHIN $\pm 10\%$ TA = 125°C $\pm$ 4°C t = 48 HOURS
----	---	---

TESTED:	4		TESTED BY:	SEE DATA
EQUIPMENT ID:	SEE DATA		DATE:	SEE DATA

3.	PRE-IRRADIATION ELECTS 71-3539	SEE PRE RAD ELECTRICAL MEASUREMENTS USE TEST PROGRAM - 70-8371
----	-----------------------------------	---

TESTED:	6		TESTED BY:	SEE DATA
PASSED:	6		DATE:	SEE DATA
FAILED:	0		EQUIPMENT ID:	SEE DATA

**INTERNATIONAL RECTIFIER  
EL SEGUNDO, CALIFORNIA**

TABLE 6  
GROUP E INSPECTON  
SUBGROUP 2  
(CONTINUED)

TOTAL DOSE, STATIC BIAS, CONDITION B  
PERFORM THIS SUBGROUP ON EACH WAFER IN EACH INSPECTION LOT  
LOT SAMPLE = 4 DEVICES/WAFER (PLUS 2 CORRELATION SAMPLES)  
0 FAIL

	TEST AND METHOD	CONDITIONS AND NOTES
4.	TOTAL DOSE IRRADIATION (COBALT 60 SOURCE)  71-3539 MIL-STD-883 TM1019, COND. B  STATIC BIAS  4 DEVICES PER WAFER	VDD = VCC = VB = 20V      VS = 400V HIN = LIN = SD = VSS = COM = 0V ALL VOLTAGES SHALL BE WITHIN $\pm 10\%$ TOTAL DOSE = 150K RAD(Si) 50 $\leq$ DOSE RATE (RAD(Si)/s) $\leq$ 300 DOSE RATE TOLERANCE IS $\pm 10\%$ REMOTE TESTING AT IR SHALL BE PERFORMED IN LIEU OF IN-FLUX TESTING. DEVICES SHALL BE TRANSPORTED TO AND FROM THE IRRADIATION SOURCE WITH THE LEADS SHORTED TO EACH OTHER.

TESTED:                    6

TESTED BY:            SEE DATA

EQUIPMENT ID: SEE DATA

DATE:                    SEE DATA

5.	ACCELERATED AGING  71-9902 MIL-STD-883 TM1019	VDD = VCC = VB = 20V      VS = 400V HIN = LIN = SD = VSS = COM = 0V ALL VOLTAGES SHALL BE WITHIN $\pm 10\%$ TA = 100°C $\pm$ 5°C t = 168 HOURS $\pm$ 12 HOURS
----	--	---

TESTED:                    4

TESTED BY:            SEE DATA

EQUIPMENT ID: SEE DATA

DATE:                    SEE DATA

6.	ELECTRICAL MEASUREMENTS 71-3539	SEE POST 150K RAD ELECTRICAL MEASUREMETS READ AND RECORD WITHIN 1 HOUR FOLLOWING ACCELERATED AGING. USE TEST PROGRAM - 70-8371
----	------------------------------------	---

TESTED:                    6

TESTED BY:            SEE DATA

PASSED:                    6

DATE:                    SEE DATA

FAILED:                    0

EQUIPMENT ID:        SEE DATA

**INTERNATIONAL RECTIFIER  
EL SEGUNDO, CALIFORNIA**

TABLE 6  
GROUP E INSPECTON  
SUBGROUP 2  
(CONTINUED)  
PRE RAD IRRADIATION TESTS AT 25°C

#	TEST NAME & SYMBOL	METHOD	CONDITION & NOTES	LIMITS		
				MIN	MAX	UNITS
1 .	INPUT VOLTAGE THRESH VIH(+ SLOPE) LO, HO VIL(- SLOPE) LO, HO  VIH (+ SLOPE) SD		5V ≤ HIN=LIN ≤15V  HIN=0V; LIN=15V 5V ≤ SD ≤15V	9.5	6.0	V
				9.5		
2 .	OUTPUT VOLTAGE LEVEL VOH LO, HO		HIN=LIN = VIH; VDD-VO IO = 0 A		1.2	
3 .	OUTPUT VOLTAGE LEVEL VOL LO, HO		HIN=LIN = VIL; VO IO = 0 A		0.1	
4 .	OFFSET SUPPLY LEAKAGE CURRENT ILK		VS = VB = HO = 400V		50	
5 .	QUIESCENT CURRENT IQBS IQCC IQDD		VIN=0V OR 15V;SD=15V		230	µA
					340	
					30	
6 .	INPUT CURRENT IIN+ HIN, LIN, SD IIN- HIN, LIN, SD		VIN=15V VIN=0V		70	
					1	
7 .	VBS UV LOCK OUT VBSUV+ HO VBSUV- HO		LIN = 0V; 5V ≤ VBS ≤15V HIN = 15V	7.5	9.7	V
				7.0	9.4	
8 .	VCC UV LOCK OUT VCCUV+ LO, HO VCCUV- LO, HO		LIN=HIN=15V; 5V ≤ VCC ≤15V	7.4	9.6	
				7.0	9.4	
9 .	OUTPUT SHORTED IO+ (0V) LO, HO IO- (15V) LO, HO		PW ≤ 10µS LIN=HIN=15V; HO=LO=0V LIN=HIN=0V; HO=LO=15V		2.0	A
					2.0	

UNLESS OTHERWISE SPECIFIED: VCC=VDD=VB=15V, VS=VSS=COM=0V, AND SD=0V

TESTED: 6  
PASSED: 6  
FAILED: 0

TESTED BY: SEE DATA  
DATE: SEE DATA  
EQUIPMENT ID: SEE DATA

**INTERNATIONAL RECTIFIER  
EL SEGUNDO, CALIFORNIA**

TABLE 6  
GROUP E INSPECTON  
SUBGROUP 2  
(CONTINUED)  
POST 150K RAD IRRADIATION TESTS AT 25°C

#	TEST NAME & SYMBOL	METHOD	CONDITION & NOTES	LIMITS		
				MIN	MAX	UNITS
1 .	INPUT VOLTAGE THRESH VIH(+ SLOPE) LO, HO		5V ≤ HIN=LIN ≤ 15V	9.5	6.0	V
	VIL(- SLOPE) LO, HO		HIN=0V; LIN=15V			
	VIH (+ SLOPE) SD		5V ≤ SD ≤ 15V	9.5		
2 .	OUTPUT VOLTAGE LEVEL VOH LO, HO		HIN=LIN = VIH; VDD-VO IO = 0 A		1.2	
3 .	OUTPUT VOLTAGE LEVEL VOL LO, HO		HIN=LIN = VIL; VO IO = 0 A		0.1	
4 .	OFFSET SUPPLY LEAKAGE CURRENT ILK		VS = VB = HO = 400V		50	
5 .	QUIESCENT CURRENT IQBS		VIN=0V OR 15V;SD=15V		1000	μA
	IQCC			1000		
	IQDD				100	
6 .	INPUT CURRENT IIN+ HIN, LIN, SD		VIN=15V		70	
	IIN- HIN, LIN, SD		VIN=0V		1	
7 .	VBS UV LOCK OUT VBSUV+ HO		LIN = 0V; 5V ≤ VBS ≤ 15V	7.5	9.7	V
	VBSUV- HO		HIN = 15V	7.0	9.4	
8 .	VCC UV LOCK OUT VCCUV+ LO, HO		LIN=HIN=15V; 5V ≤ VCC ≤ 15V	7.4	9.9	
	VCCUV- LO, HO			7.0	9.6	
9 .	OUTPUT SHORTED IO+ (0V) LO, HO		PW ≤ 10μs LIN=HIN=15V; HO=LO=0V	2.0		A
	IO- (15V) LO, HO		LIN=HIN=0V; HO=LO=15V	2.0		

UNLESS OTHERWISE SPECIFIED: VCC=VDD=VB=15V, VS=VSS=COM=0V, AND SD=0V

TESTED: 6  
PASSED: 6  
FAILED: 0

TESTED BY: SEE DATA  
DATE: SEE DATA  
EQUIPMENT ID: SEE DATA



**INTERNATIONAL RECTIFIER  
EL SEGUNDO, CALIFORNIA**

TABLE 6

GROUP E INSPECTON  
SUBGROUP 3  
PERFORM THIS SUBGROUP AS A QUALIFICATION TEST

TOTAL DOSE, DYNAMIC BIAS, CONDITION B

LOT SAMPLE = 12 DEVICES (PLUS 2 CORRELATION SAMPLES)  
0 FAIL

	TEST AND METHOD	CONDITIONS AND NOTES
1.	PRE-IRRADIATION ELECTS 71-3539	SEE PRE RAD ELECTRICAL MEASUREMENTS USE TEST PROGRAM - 70-8371

TESTED:	14	TESTED BY:	SEE DATA
PASSED:	14	DATE:	SEE DATA
FAILED:	0	EQUIPMENT ID:	SEE DATA

2.	BURN-IN  71-9902 MIL-STD-883 TM1005, COND. A	VDD = VCC = VB = 20V      VS = 400V HIN = LIN = SD = VSS = COM = 0V ALL VOLTAGES SHALL BE WITHIN ± 10% TA = 125°C ± 4°C t = 48 HOURS
----	---	--

TESTED:	12	TESTED BY:	SEE DATA
EQUIPMENT ID:	SEE DATA	DATE:	SEE DATA

3.	PRE-IRRADIATION ELECTS 71-3539	SEE PRE RAD ELECTRICAL MEASUREMENTS USE TEST PROGRAM - 70-8371
----	-----------------------------------	---

TESTED:	14	TESTED BY:	SEE DATA
PASSED:	14	DATE:	SEE DATA
FAILED:	0	EQUIPMENT ID:	SEE DATA

**INTERNATIONAL RECTIFIER  
EL SEGUNDO, CALIFORNIA**

TABLE 6  
GROUP E INSPECTON  
SUBGROUP 3  
(CONTINUED)

TOTAL DOSE, DYNAMIC BIAS, CONDITION B  
PERFORM THIS SUBGROUP AS A QUALIFICATION TEST  
LOT SAMPLE = 12 DEVICES (PLUS 2 CORRELATION SAMPLES)  
0 FAIL

	TEST AND METHOD	CONDITIONS AND NOTES
4.	TOTAL DOSE IRRADIATION (COBALT 60 SOURCE)  71-3539 MIL-STD-883 TM1019, COND. B  DYNAMIC BIAS  12 DEVICES	VDD = VCC = VB = 20V      VS = 400V HIN = LIN = 1 KHz SQUARE WAVE (20Vpk) LOAD AT HO AND LO = 1000pF SD = VSS = COM = 0V ALL VOLTAGES SHALL BE WITHIN $\pm 10\%$ TOTAL DOSE = 150K RAD(Si) $50 \leq \text{DOSE RATE (RAD(Si)/s)} \leq 300$ DOSE RATE TOLERANCE IS $\pm 10\%$ REMOTE TESTING AT IR SHALL BE PERFORMED IN LIEU OF IN-FLUX TESTING. DEVICES SHALL BE TRANSPORTED TO AND FROM THE IRRADIATION SOURCE WITH THE LEADS SHORTED TO EACH OTHER.

TESTED:                    12

TESTED BY:            SEE DATA

EQUIPMENT ID: SEE DATA

DATE:                    SEE DATA

5.	ACCELERATED AGING  71-9902 MIL-STD-883 TM1019	VDD = VCC = VB = 20V      VS = 400V HIN = LIN = SD = VSS = COM = 0V ALL VOLTAGES SHALL BE WITHIN $\pm 10\%$ TA = 100°C $\pm 5^\circ\text{C}$ t = 168 HOURS $\pm 12$ HOURS
----	--	---

TESTED:                    12

TESTED BY:            SEE DATA

EQUIPMENT ID: SEE DATA

DATE:                    SEE DATA

6.	ELECTRICAL MEASUREMENTS 71-3539	SEE POST 150K RAD ELECTRICAL MEASUREMENTS READ AND RECORD WITHIN 1 HOUR FOLLOWING IRRADIATION. USE TEST PROGRAM - 70-8371
----	------------------------------------	--

TESTED:                    14

TESTED BY:            SEE DATA

PASSED:                  14

DATE:                    SEE DATA

FAILED:                    0

EQUIPMENT ID:        SEE DATA

**INTERNATIONAL RECTIFIER  
EL SEGUNDO, CALIFORNIA**

TABLE 6  
GROUP E INSPECTON  
SUBGROUP 3  
(CONTINUED)

PRE RAD IRRADIATION TESTS AT 25°C

#	TEST NAME & SYMBOL	METHOD	CONDITION & NOTES	LIMITS		
				MIN	MAX	UNITS
1 .	INPUT VOLTAGE THRESH VIH(+ SLOPE) LO, HO VIL(- SLOPE) LO, HO  VIH (+ SLOPE) SD		5V ≤ HIN=LIN ≤15V  HIN=0V; LIN=15V 5V ≤ SD ≤15V	9.5	6.0	V
				9.5		
2 .	OUTPUT VOLTAGE LEVEL VOH LO, HO		HIN=LIN = VIH; VDD-VO IO = 0 A		1.2	
3 .	OUTPUT VOLTAGE LEVEL VOL LO, HO		HIN=LIN = VIL; VO IO = 0 A		0.1	
4 .	OFFSET SUPPLY LEAKAGE CURRENT ILK		VS = VB = HO = 400V		50	
5 .	QUIESCENT CURRENT IQBS IQCC IQDD		VIN=0V OR 15V; SD=15V		230	μA
					340	
					30	
6 .	INPUT CURRENT IIN+ HIN, LIN, SD IIN- HIN, LIN, SD		VIN=15V VIN=0V		70	
					1	
7 .	VBS UV LOCK OUT VBSUV+ HO VBSUV- HO		LIN = 0V; 5V ≤ VBS ≤15V HIN = 15V	7.5	9.7	V
				7.0	9.4	
8 .	VCC UV LOCK OUT VCCUV+ LO, HO VCCUV- LO, HO		LIN=HIN=15V; 5V ≤ VCC ≤15V	7.4	9.6	
				7.0	9.4	
9 .	OUTPUT SHORTED IO+ (0V) LO, HO IO- (15V) LO, HO		PW ≤ 10μs LIN=HIN=15V; HO=LO=0V LIN=HIN=0V; HO=LO=15V	2.0		A
				2.0		

UNLESS OTHERWISE SPECIFIED: VCC=VDD=VB=15V, VS=VSS=COM=0V, AND SD=0V

TESTED: 14  
PASSED: 14  
FAILED: 0

TESTED BY: SEE DATA  
DATE: SEE DATA  
EQUIPMENT ID: SEE DATA

**INTERNATIONAL RECTIFIER  
EL SEGUNDO, CALIFORNIA**

TABLE 6  
GROUP E INSPECTON  
SUBGROUP 3  
(CONTINUED)  
POST 150K RAD IRRADIATION TESTS AT 25°C

#	TEST NAME & SYMBOL	METHOD	CONDITION & NOTES	LIMITS		
				MIN	MAX	UNITS
1 .	INPUT VOLTAGE THRESH VIH(+ SLOPE) LO, HO VIL(- SLOPE) LO, HO		5V ≤ HIN=LIN ≤ 15V	9.5	6.0	V
	VIH (+ SLOPE) SD		HIN=0V; LIN=15V 5V ≤ SD ≤ 15V	9.5		
2 .	OUTPUT VOLTAGE LEVEL VOH LO, HO		HIN=LIN = VIH; VDD-VO IO = 0 A		1.2	
3 .	OUTPUT VOLTAGE LEVEL VOL LO, HO		HIN=LIN = VIL; VO IO = 0 A		0.1	
4 .	OFFSET SUPPLY LEAKAGE CURRENT ILK		VS = VB = HO = 400V		50	
5 .	QUIESCENT CURRENT IQBS		VIN=0V OR 15V; SD=15V		1000	µA
	IQCC			1000		
	IQDD				100	
6 .	INPUT CURRENT IIN+ HIN, LIN, SD		VIN=15V		70	
	IIN- HIN, LIN, SD		VIN=0V		1	
7 .	VBS UV LOCK OUT VBSUV+ HO		LIN = 0V; 5V ≤ VBS ≤ 15V	7.5	9.7	V
	VBSUV- HO		HIN = 15V	7.0	9.4	
8 .	VCC UV LOCK OUT VCCUV+ LO, HO		LIN=HIN=15V; 5V ≤ VCC ≤ 15V	7.4	9.9	
	VCCUV- LO, HO			7.0	9.6	
9 .	OUTPUT SHORTED IO+ (0V) LO, HO		PW ≤ 10µS LIN=HIN=15V; HO=LO=0V	2.0		A
	IO- (15V) LO, HO		LIN=HIN=0V; HO=LO=15V	2.0		

UNLESS OTHERWISE SPECIFIED: VCC=VDD=VB=15V, VS=VSS=COM=0V, AND SD=0V

TESTED: 14  
PASSED: 14  
FAILED: 0

TESTED BY: SEE DATA  
DATE: SEE DATA  
EQUIPMENT ID: SEE DATA

INTERNATIONAL RECTIFIER  
EL SEGUNDO, CALIFORNIA

# Appendix B

## Electrical Test Results

INTERNATIONAL RECTIFIER  
EL SEGUNDO, CALIFORNIA

## Appendix B1

Pre Burnin Electricals

**INTERNATIONAL RECTIFIER  
EL SEGUNDO, CALIFORNIA  
TEST SUMMARY**

CUSTOMER: IR  
 DEVICE : RIC7113L4  
 SPEC NO. : DOC:71-9837-17 REV:06 (c)SZ  
 JOB NO. : NA

L.D.C. : 800819  
 LOT NO: B7607  
 DATE : 01/13/2000  
 Location: PRE ELECTRICALS

<b>Total Units Tested: 73</b>	<b>Total units Passed: 72</b>	<b>Electrical Yield: %98.63</b>
-------------------------------	-------------------------------	---------------------------------

TESTS	Failed Qty	% Loss	Failed Serial Numbers
CONT_OPN			
DIOD_SHT			
V_MAX			
I_LEAK			
IQDD0			
IQCC0			
IQBS0			
IHIN0			
ILIN0			
ISD0			
IQDD1			
IQCC1			
IQBS1			
IHIN1			
ILIN1			
ISD1			
ILO+			
ILO-			
IHO+	1	%1.37	8
IHO-			
FN_15/15			
VOH_LS			
VOL_LS			
VOL_HS			
VOH_HS			
Vth+HS			
Vth-HS			
Vth+LS			
Vth-LS			
Vth+SD			
TON_LS			
TOFF_LS			
TR_LS			
TF_LS			
TON_HS			
TOFF_HS			
TR_HS			
TF_HS			
TSD_LS			
TSD_HS			
MT_ON			
MT_OFF			
VCCUV+pa			
VCCUV-pa			
VBSUV+pa			
VBSUV-pa			
IQDD1			
IQCC1			
IQBS1			
D_IQDD1			
D_IQCC1			
D_IQBS1			

**INTERNATIONAL RECTIFIER  
EL SEGUNDO, CALIFORNIA**

CUSTOMER: IR  
 DEVICE : RIC7113L4  
 SPEC NO. : DOC:71-9837-17 REV:06 (c)SZ  
 JOB NO. : NA

L.D.C. : 800819  
 LOT NO: B7607  
 DATE : 01/13/2000  
 Location: PRE ELECTRICALS

TESTS	LIMITS	1	2	3	4	5	6	7	8 [F]	9	10
CONT_OPN	0 to 0	0	0	0	0	0	0	0	0	0	0
DIOD_SHT	0 to 0	0	0	0	0	0	0	0	0	0	0
V_MAX	425 to 990 V	N/A	N/A	N/A	N/A	N/A	N/A	N/A	N/A	N/A	N/A
I_LEAK	-1 to 50 uA	1.8	1.7	1.6	1.4	1.2	1.9	1.6	1.1	1.3	1.3
IQDD0	0 to 30 uA	0.046	0.043	0.041	0.038	0.041	0.042	0.040	0.038	0.039	0.040
IQCC0	0 to 340 uA	90.6	90.4	90.9	92.1	113.4	90.6	90.8	90.3	94.2	95.1
IQBS0	0 to 230 uA	69.4	69.8	68.9	69.7	67.5	69.3	68.8	69.2	76.0	77.9
IHIN0	0 to 1 uA	0.016	0.012	0.013	0.013	0.013	0.012	0.012	0.012	0.013	0.013
ILIN0	0 to 1 uA	0.016	0.013	0.013	0.013	0.013	0.013	0.013	0.013	0.013	0.013
ISD0	0 to 1 uA	0.016	0.012	0.012	0.013	0.012	0.012	0.012	0.012	0.013	0.013
IQDD1	0 to 30 uA	0.053	0.051	0.054	0.051	0.048	0.051	0.050	0.050	0.049	0.050
IQCC1	0 to 340 uA	98.2	98.8	99.0	100.6	128.8	98.6	98.6	98.1	102.7	103.9
IQBS1	0 to 230 uA	53.5	54.1	52.8	53.4	51.2	53.5	52.8	53.4	59.1	60.8
IHIN1	0 to 40 uA	23.6	23.7	23.9	24.5	24.5	23.7	23.8	23.9	24.7	24.8
ILIN1	0 to 40 uA	23.9	24.1	24.4	24.9	24.7	24.2	24.1	24.1	25.0	25.2
ISD1	0 to 40 uA	23.7	23.8	24.0	24.6	24.3	23.8	23.8	23.9	24.7	24.8
ILO+	2 to 5 A	2.7	2.6	2.7	2.7	2.6	2.7	2.6	2.6	3.0	3.0
ILO-	2 to 5 A	3.1	3.2	3.1	3.1	3.0	3.2	3.1	3.1	3.4	3.4
IHO+	2 to 5 A	2.5	2.5	2.5	2.5	2.4	2.5	2.5	0 F	2.7	2.8
IHO-	2 to 5 A	3.4	3.4	3.4	3.3	3.3	3.4	3.4	0 F	3.6	3.7
FN_15/15	1 to 1	1	1	1	1	1	1	1	0 F	1	1
VOH_LS	0 to 1.2 V	0.489	0.491	0.495	0.480	0.499	0.490	0.492	0.492	0.463	0.461
VOL_LS	-0.01 to 0.1 V	0	0	0	0	0	0	0	0	0	0
VOL_HS	-0.01 to 0.1 V	0	0	0	0	0	0	0	0.077	0	0
VOH_HS	0 to 1.2 V	0.467	0.466	0.468	0.458	0.477	0.468	0.471	11.7 F	0.438	0.435
Vth+HS	6 to 9.5 V	8.3	8.3	8.3	8.3	8.3	8.3	8.3	11.1 F	8.4	8.4
Vth-HS	6 to 9.5 V	6.8	6.8	6.8	6.8	6.7	6.8	6.8	11.1 F	7.0	7.0
Vth+LS	6 to 9.5 V	8.3	8.3	8.3	8.3	8.3	8.3	8.3	8.3	8.4	8.4
Vth-LS	6 to 9.5 V	6.7	6.7	6.7	6.7	6.7	6.8	6.7	6.7	7.0	7.0
Vth+SD	6 to 9.5 V	8.3	8.3	8.3	8.3	8.3	8.3	8.3	8.3	8.4	8.4
TON_LS	50 to 200 ns	134.2	137.5	138.0	141.4	148.9	134.9	138.5	141.1	116.2	115.7
TOFF_LS	50 to 200 ns	122.9	124.8	125.2	127.8	132.3	123.6	126	126.3	108.6	107.3
TR_LS	2 to 35 ns	15.5	14.7	14.6	14.9	15.2	15.9	15.2	8.5	14.3	13.2
TF_LS	2 to 25 ns	7.1	7.0	7.6	7.5	7.5	7.0	7.5	6.3	6.6	6.8
TON_HS	50 to 200 ns	127.5	128.9	129.9	132.6	138.6	128.4	130.5	-100180	110.6	108.0
TOFF_HS	50 to 200 ns	116.2	117.4	117.3	119.9	125.1	116.2	118.3	-100180	101.8	99.9
TR_HS	2 to 35 ns	18.8	18.7	18.7	18.9	19.1	18.7	18.7	3.3	17.9	17.7
TF_HS	2 to 25 ns	15.0	14.4	14.7	14.8	15.3	14.6	14.4	3.3	14.2	13.6
TSD_LS	50 to 140 ns	122.3	124.4	126.1	128.0	133.0	123.5	126.2	126.4	108.3	107.8
TSD_HS	50 to 140 ns	122.0	123.8	124.8	127.6	133.1	122.6	124.7	-100170	106.1	103.9
MT_ON	0 to 20 ns	6.7	8.6	8.1	8.8	10.3	6.5	8.0	100319	5.7	7.7
MT_OFF	0 to 20 ns	6.7	7.4	7.8	8.0	7.2	7.4	7.7	100307	6.8	7.4
VCCUV+pa	7.4 to 9.6 V	8.4	8.5	8.4	8.5	8.5	8.4	8.5	2.9 F	8.4	8.5
VCCUV-pa	7 to 9.4 V	8.2	8.2	8.2	8.2	8.2	8.2	8.2	2.9 F	8.2	8.2
VBSUV+pa	7.5 to 9.7 V	8.5	8.5	8.4	8.4	8.5	8.5	8.6	2.9 F	8.5	8.5
VBSUV-pa	7 to 9.4 V	8.2	8.3	8.1	8.1	8.3	8.2	8.3	2.9 F	8.2	8.2
IQDD1	0 to 30 uA	0.051	0.050	0.049	0.051	0.049	0.052	0.049	0.051	0.049	0.049
IQCC1	0 to 340 uA	98.3	98.8	98.8	100.6	128.9	98.8	98.6	98.5	102.4	104.0
IQBS1	0 to 230 uA	53.4	54.0	52.8	53.4	51.1	53.5	52.6	53.1	59.1	61.0
D_IQDD1	0 to 3 uA	0.001	0.001	0.005	0	0	0	0	0	0	0.001
D_IQCC1	0 to 30 uA	0.125	0	0.188	0	0.125	0.125	0.063	0.375	0.250	0.063
D_IQBS1	0 to 20 uA	0.063	0.125	0	0.063	0.125	0	0.188	0.313	0.063	0.250



**INTERNATIONAL RECTIFIER  
EL SEGUNDO, CALIFORNIA**

CUSTOMER: IR  
 DEVICE : RIC7113L4  
 SPEC NO. : DOC:71-9837-17 REV:06 (c)SZ  
 JOB NO. : NA

L.D.C. : 800819  
 LOT NO: B7607  
 DATE : 01/13/2000  
 Location: PRE ELECTRICALS

TESTS	LIMITS	11	12	13	14	15	16	17	18	19	20
CONT_OPN	0 to 0	0	0	0	0	0	0	0	0	0	0
DIOD_SHT	0 to 0	0	0	0	0	0	0	0	0	0	0
V_MAX	425 to 990 V	N/A	N/A	N/A	N/A	N/A	N/A	N/A	N/A	N/A	N/A
I_LEAK	-1 to 50 uA	1.2	1.5	1.1	1.1	1.5	1.7	1.5	2.2	1.3	1.3
IQDD0	0 to 30 uA	0.039	0.041	0.039	0.038	0.038	0.041	0.040	0.040	0.041	0.038
IQCC0	0 to 340 uA	94.6	93.8	94.3	94.5	94.2	94.7	94.5	94.0	90.2	90.9
IQBS0	0 to 230 uA	77.4	77.6	76.6	78.2	76.6	79.1	77.8	78.0	67.0	69.3
IHIN0	0 to 1 uA	0.013	0.013	0.013	0.013	0.013	0.013	0.013	0.013	0.012	0.013
ILIN0	0 to 1 uA	0.013	0.013	0.013	0.013	0.013	0.013	0.013	0.013	0.012	0.013
ISD0	0 to 1 uA	0.013	0.012	0.013	0.013	0.013	0.013	0.013	0.012	0.012	0.012
IQDD1	0 to 30 uA	0.048	0.050	0.049	0.051	0.049	0.050	0.049	0.049	0.052	0.050
IQCC1	0 to 340 uA	103.0	102.6	102.6	102.9	102.8	103.8	103.0	103.0	98.0	99.3
IQBS1	0 to 230 uA	59.8	60.9	59.4	61.0	59.4	62.1	60.3	61.1	50.9	52.1
IHIN1	0 to 40 uA	24.8	24.6	24.9	24.7	24.7	24.9	24.8	24.6	23.7	24.4
ILIN1	0 to 40 uA	25.2	25.0	25.3	25.0	25.2	25.2	25.2	25.1	24.0	24.6
ISD1	0 to 40 uA	24.8	24.6	24.8	24.7	24.8	24.8	24.8	24.5	23.7	24.3
ILO+	2 to 5 A	3.0	3.0	2.8	2.9	2.9	3.0	3.0	3.0	2.6	2.5
ILO-	2 to 5 A	3.4	3.4	3.3	3.4	3.3	3.4	3.4	3.4	3.0	3.0
IHO+	2 to 5 A	2.8	2.8	2.7	2.8	2.7	2.8	2.8	2.8	2.4	2.4
IHO-	2 to 5 A	3.6	3.6	3.6	3.6	3.6	3.7	3.6	3.7	3.3	3.2
FN_15/15	1 to 1	1	1	1	1	1	1	1	1	1	1
VOH_LS	0 to 1.2 V	0.464	0.459	0.476	0.460	0.476	0.462	0.461	0.458	0.515	0.517
VOL_LS	-0.01 to 0.1 V	0	0	0	0	0	0	0	0	0	0
VOL_HS	-0.01 to 0.1 V	0	0	0	0	0	0	0	0	0	0
VOH_HS	0 to 1.2 V	0.441	0.438	0.451	0.438	0.453	0.436	0.440	0.436	0.494	0.493
Vth+HS	6 to 9.5 V	8.4	8.4	8.3	8.4	8.3	8.4	8.4	8.4	8.3	8.3
Vth-HS	6 to 9.5 V	7.0	7.0	6.9	7.0	6.9	7.0	7.0	7.0	6.7	6.7
Vth+LS	6 to 9.5 V	8.4	8.3	8.3	8.3	8.3	8.3	8.4	8.4	8.3	8.3
Vth-LS	6 to 9.5 V	7.0	7.0	6.8	6.9	6.8	7.0	7.0	7.0	6.7	6.7
Vth+SD	6 to 9.5 V	8.4	8.3	8.3	8.3	8.3	8.4	8.4	8.4	8.3	8.3
TON_LS	50 to 200 ns	117.7	116.0	121.9	114.4	121.5	114.8	115.6	115.7	135.4	136.1
TOFF_LS	50 to 200 ns	109.1	107.8	111.8	107.1	111.6	106.5	108.3	107.0	119.4	121.0
TR_LS	2 to 35 ns	13.7	13.3	15.3	14.6	15.4	14.3	14.3	13.3	15.9	15.2
TF_LS	2 to 25 ns	7.0	6.7	6.7	6.7	6.7	6.6	6.7	6.9	6.9	6.6
TON_HS	50 to 200 ns	110.4	108.1	115.3	107.7	115.2	107.3	109.5	107.6	132.3	133.7
TOFF_HS	50 to 200 ns	101.8	99.6	105.3	99.5	105.3	98.9	100.7	99.2	117.8	119.4
TR_HS	2 to 35 ns	17.6	17.6	18.5	17.7	18.4	17.7	17.9	17.5	18.8	18.6
TF_HS	2 to 25 ns	13.9	13.5	14.8	12.9	15.2	13.6	13.8	13.5	13.7	14.1
TSD_LS	50 to 140 ns	108.9	106.9	111.3	106.8	110.8	106.1	108.0	107.4	120.2	120.8
TSD_HS	50 to 140 ns	106.1	103.6	110.1	104.3	109.9	102.7	105.1	103.2	125.7	126.8
MT_ON	0 to 20 ns	7.4	7.9	6.6	6.7	6.3	7.5	6.2	8.1	3.1	2.4
MT_OFF	0 to 20 ns	7.4	8.1	6.5	7.7	6.2	7.6	7.5	7.8	1.7	1.7
VCCUV+pa	7.4 to 9.6 V	8.4	8.5	8.5	8.4	8.4	8.4	8.5	8.5	8.4	8.4
VCCUV-pa	7 to 9.4 V	8.2	8.2	8.2	8.2	8.2	8.2	8.2	8.2	8.2	8.2
VBSUV+pa	7.5 to 9.7 V	8.5	8.5	8.5	8.5	8.5	8.5	8.5	8.5	8.5	8.5
VBSUV-pa	7 to 9.4 V	8.3	8.3	8.3	8.2	8.3	8.3	8.3	8.3	8.2	8.2
IQDD1	0 to 30 uA	0.051	0.052	0.050	0.050	0.048	0.051	0.049	0.051	0.051	0.050
IQCC1	0 to 340 uA	102.9	102.9	102.6	102.9	102.9	103.9	103.3	102.9	97.9	99.1
IQBS1	0 to 230 uA	59.8	60.6	59.6	61.2	59.3	62.3	60.4	61.1	50.7	52.5
D_IQDD1	0 to 3 uA	0.003	0.002	0	0	0.001	0.001	0	0.002	0.001	0
D_IQCC1	0 to 30 uA	0.063	0.313	0	0.063	0.125	0.125	0.250	0.063	0.063	0.125
D_IQBS1	0 to 20 uA	0	0.250	0.188	0.188	0.063	0.188	0.063	0	0.188	0.375

**INTERNATIONAL RECTIFIER  
EL SEGUNDO, CALIFORNIA**

CUSTOMER: IR  
 DEVICE : RIC7113L4  
 SPEC NO. : DOC:71-9837-17 REV:06 (c)SZ  
 JOB NO. : NA

L.D.C. : 800819  
 LOT NO: B7607  
 DATE : 01/13/2000  
 Location: PRE ELECTRICALS

TESTS	LIMITS	21	22	23	24	25	26	27	28	29	30
CONT_OPN	0 to 0	0	0	0	0	0	0	0	0	0	0
DIOD_SHT	0 to 0	0	0	0	0	0	0	0	0	0	0
V_MAX	425 to 990 V	N/A	N/A	N/A	N/A	N/A	N/A	N/A	N/A	N/A	N/A
I_LEAK	-1 to 50 uA	1.2	1.4	1.6	1.9	1.2	1.4	1.4	0.993	1.7	1.2
IQDD0	0 to 30 uA	0.040	0.041	0.038	0.038	0.039	0.040	0.043	0.040	0.041	0.041
IQCC0	0 to 340 uA	90.9	89.9	89.4	91.4	91.4	91.3	89.5	92.1	92.4	91.7
IQBS0	0 to 230 uA	69.0	67.4	67.0	69.1	69.0	68.8	67.3	73.1	73.6	71.9
IHIN0	0 to 1 uA	0.013	0.012	0.012	0.013	0.013	0.013	0.012	0.013	0.012	0.012
ILIN0	0 to 1 uA	0.013	0.012	0.012	0.013	0.013	0.013	0.012	0.013	0.013	0.013
ISD0	0 to 1 uA	0.012	0.012	0.012	0.012	0.012	0.012	0.012	0.012	0.012	0.012
IQDD1	0 to 30 uA	0.051	0.048	0.051	0.050	0.053	0.050	0.052	0.049	0.051	0.051
IQCC1	0 to 340 uA	99.8	98.4	97.9	100.6	99.7	100.0	97.8	100.4	100.5	99.8
IQBS1	0 to 230 uA	51.9	51.4	51.0	52.4	52.1	51.4	50.9	56.9	57.6	56.0
IHIN1	0 to 40 uA	24.3	23.7	23.7	24.4	24.1	24.4	23.7	24.2	23.8	23.9
ILIN1	0 to 40 uA	24.7	24.0	24.0	25.0	24.6	24.8	24.0	24.6	24.4	24.4
ISD1	0 to 40 uA	24.2	23.8	23.7	24.6	24.2	24.4	23.6	24.3	23.9	24.0
ILO+	2 to 5 A	2.5	2.6	2.6	2.5	2.5	2.6	2.5	2.8	2.9	2.8
ILO-	2 to 5 A	3.0	3.0	3.0	3.0	3.0	3.0	2.9	3.2	3.3	3.3
IHO+	2 to 5 A	2.3	2.4	2.4	2.3	2.3	2.4	2.4	2.6	2.7	2.6
IHO-	2 to 5 A	3.2	3.3	3.3	3.2	3.2	3.3	3.3	3.5	3.6	3.5
FN_15/15	1 to 1	1	1	1	1	1	1	1	1	1	1
VOH_LS	0 to 1.2 V	0.514	0.515	0.517	0.517	0.519	0.512	0.517	0.495	0.490	0.500
VOL_LS	-0.01 to 0.1 V	0	0	0	0	0	0	0	0	0	0
VOL_HS	-0.01 to 0.1 V	0	0	0	0	0	0	0	0	0	0
VOH_HS	0 to 1.2 V	0.493	0.493	0.494	0.493	0.499	0.490	0.492	0.473	0.468	0.474
Vth+HS	6 to 9.5 V	8.3	8.3	8.3	8.3	8.3	8.3	8.3	8.4	8.4	8.3
Vth-HS	6 to 9.5 V	6.7	6.7	6.7	6.7	6.7	6.7	6.7	6.9	6.9	6.9
Vth+LS	6 to 9.5 V	8.3	8.3	8.3	8.3	8.3	8.3	8.3	8.3	8.4	8.3
Vth-LS	6 to 9.5 V	6.7	6.7	6.7	6.7	6.7	6.7	6.7	6.8	6.9	6.8
Vth+SD	6 to 9.5 V	8.3	8.3	8.3	8.3	8.3	8.3	8.3	8.3	8.4	8.3
TON_LS	50 to 200 ns	135.2	133.8	136.3	135.5	133.5	136.2	135.4	119.9	113.8	119.7
TOFF_LS	50 to 200 ns	117.7	118.9	120.5	119.6	117.7	119.9	120.1	107.7	103.2	107.6
TR_LS	2 to 35 ns	15.3	15.9	15.9	15.3	14.9	14.8	15.9	15.7	16.0	16.1
TF_LS	2 to 25 ns	6.6	6.5	6.6	6.8	6.8	7.0	6.4	6.7	6.6	6.5
TON_HS	50 to 200 ns	132.8	130.1	132.3	132.4	131.4	133.6	131.7	115.8	110.3	115.7
TOFF_HS	50 to 200 ns	118.0	116.2	118.4	118.5	117.0	119.2	117.8	104.1	99.4	103.8
TR_HS	2 to 35 ns	18.7	18.9	19.2	18.7	17.8	18.4	19.0	18.3	18.3	18.2
TF_HS	2 to 25 ns	12.1	13.8	14.1	12.6	10.3	11.4	14.1	12.4	12.0	12.7
TSD_LS	50 to 140 ns	119.4	118.8	120.6	120.0	118.0	121.5	120.0	106.8	102.3	106.9
TSD_HS	50 to 140 ns	126.9	123.9	125.9	126.6	125.2	127.8	125.1	109.1	104.3	108.9
MT_ON	0 to 20 ns	2.4	3.7	4.0	3.1	2.1	2.6	3.6	4.2	3.5	4.0
MT_OFF	0 to 20 ns	0.300	2.7	2.1	1.1	0.770	0.710	2.3	3.6	3.8	3.8
VCCUV+pa	7.4 to 9.6 V	8.4	8.4	8.4	8.4	8.4	8.4	8.4	8.4	8.4	8.4
VCCUV-pa	7 to 9.4 V	8.2	8.2	8.2	8.1	8.1	8.2	8.2	8.1	8.2	8.1
VBSUV+pa	7.5 to 9.7 V	8.5	8.5	8.5	8.5	8.5	8.4	8.5	8.5	8.5	8.5
VBSUV-pa	7 to 9.4 V	8.2	8.2	8.2	8.2	8.2	8.2	8.2	8.2	8.2	8.2
IQDD1	0 to 30 uA	0.051	0.052	0.049	0.049	0.049	0.050	0.052	0.050	0.048	0.049
IQCC1	0 to 340 uA	99.8	98.5	97.7	100.3	99.5	100.1	98.2	100.1	100.5	100.0
IQBS1	0 to 230 uA	52.2	51.4	50.7	52.1	52.1	51.2	50.9	56.9	57.9	56.3
D_IQDD1	0 to 3 uA	0	0.004	0.002	0.001	0.004	0	0	0	0.003	0.002
D_IQCC1	0 to 30 uA	0.063	0.125	0.250	0.250	0.188	0.125	0.438	0.313	0	0.250
D_IQBS1	0 to 20 uA	0.313	0.063	0.313	0.250	0	0.250	0	0.063	0.250	0.250

**INTERNATIONAL RECTIFIER  
EL SEGUNDO, CALIFORNIA**

CUSTOMER: IR  
 DEVICE : RIC7113L4  
 SPEC NO. : DOC:71-9837-17 REV:06 (c)SZ  
 JOB NO. : NA

L.D.C. : 800819  
 LOT NO: B7607  
 DATE : 01/13/2000  
 Location: PRE ELECTRICALS

TESTS	LIMITS	31	32	33	34	35	36	37	38	39	40
CONT_OPN	0 to 0	0	0	0	0	0	0	0	0	0	0
DIOD_SHT	0 to 0	0	0	0	0	0	0	0	0	0	0
V_MAX	425 to 990 V	N/A	N/A	N/A	N/A	N/A	N/A	N/A	N/A	N/A	N/A
I_LEAK	-1 to 50 uA	1.0	2.1	1.9	1.1	1.5	1.7	1.4	1.6	1.8	1.4
IQDD0	0 to 30 uA	0.040	0.041	0.038	0.036	0.042	0.037	0.036	0.037	0.039	0.037
IQCC0	0 to 340 uA	91.2	91.8	91.5	92.1	91.2	91.1	91.7	96.6	97.3	96.3
IQBS0	0 to 230 uA	73.2	73.5	72.3	73.0	72.3	72.9	72.4	72.7	73.6	73.5
IHIN0	0 to 1 uA	0.013	0.013	0.012	0.012	0.012	0.013	0.013	0.013	0.013	0.013
ILIN0	0 to 1 uA	0.013	0.013	0.013	0.013	0.013	0.013	0.013	0.013	0.013	0.013
ISD0	0 to 1 uA	0.012	0.012	0.012	0.012	0.012	0.012	0.012	0.012	0.013	0.013
IQDD1	0 to 30 uA	0.053	0.048	0.053	0.051	0.050	0.053	0.049	0.051	0.050	0.050
IQCC1	0 to 340 uA	99.6	100.1	99.8	100.3	99.4	99.5	100.1	105.4	105.8	104.8
IQBS1	0 to 230 uA	56.9	57.4	55.9	56.4	55.9	56.4	56.8	55.6	56.7	55.9
IHIN1	0 to 40 uA	23.9	24.2	23.9	24.0	23.8	24.1	24.1	24.6	24.8	24.7
ILIN1	0 to 40 uA	24.4	24.5	24.3	24.5	24.1	24.4	24.5	25.0	25.2	25.2
ISD1	0 to 40 uA	24.0	24.2	24.0	24.1	23.8	24.1	24.2	24.6	24.8	24.7
ILO+	2 to 5 A	2.8	2.7	2.8	2.8	2.8	2.8	2.8	2.5	2.4	2.5
ILO-	2 to 5 A	3.3	3.3	3.2	3.2	3.3	3.2	3.3	2.9	2.9	2.9
IHO+	2 to 5 A	2.7	2.6	2.6	2.6	2.6	2.6	2.6	2.3	2.3	2.3
IHO-	2 to 5 A	3.5	3.5	3.5	3.5	3.5	3.5	3.5	3.2	3.1	3.2
FN_15/15	1 to 1	1	1	1	1	1	1	1	1	1	1
VOH_LS	0 to 1.2 V	0.498	0.499	0.497	0.497	0.500	0.496	0.495	0.618	0.612	0.609
VOL_LS	-0.01 to 0.1 V	0	0	0	0	0	0	0	0	0	0
VOL_HS	-0.01 to 0.1 V	0	0	0	0	0	0	0	0	0	0
VOH_HS	0 to 1.2 V	0.475	0.473	0.476	0.476	0.475	0.474	0.475	0.597	0.583	0.591
Vth+HS	6 to 9.5 V	8.4	8.4	8.3	8.3	8.3	8.4	8.3	8.4	8.5	8.4
Vth-HS	6 to 9.5 V	6.9	6.9	6.8	6.8	6.9	6.9	6.9	6.8	6.8	6.8
Vth+LS	6 to 9.5 V	8.4	8.3	8.3	8.3	8.3	8.3	8.3	8.4	8.4	8.4
Vth-LS	6 to 9.5 V	6.9	6.8	6.8	6.8	6.8	6.8	6.8	6.8	6.8	6.8
Vth+SD	6 to 9.5 V	8.4	8.3	8.3	8.3	8.3	8.3	8.3	8.5	8.4	8.5
TON_LS	50 to 200 ns	118.5	116.8	119.0	119.6	119.0	119.3	118.7	145.6	145.1	147.8
TOFF_LS	50 to 200 ns	106.9	105.2	107.2	106.3	107.5	107.0	106.4	129.4	129.6	130.6
TR_LS	2 to 35 ns	15.5	15.5	15.8	15.8	15.8	15.7	16.1	15.2	15.2	15.5
TF_LS	2 to 25 ns	7.1	6.7	6.6	6.9	6.6	6.6	6.6	6.6	6.5	6.7
TON_HS	50 to 200 ns	114.9	113.8	115.5	115.7	115.7	115.4	114.6	140.3	140.6	141.4
TOFF_HS	50 to 200 ns	103.6	102.5	104.3	103.9	104.8	104.1	103.7	126.5	127	127.1
TR_HS	2 to 35 ns	18.3	18.1	18.0	18.2	18.4	18.2	18.4	19.2	19.1	19.1
TF_HS	2 to 25 ns	12.4	12.8	12.8	13.1	12.9	12.4	12.9	13.1	13.2	13.6
TSD_LS	50 to 140 ns	106.3	104.8	107.7	105.9	106.9	106.4	106.3	129.8	129.6	130.3
TSD_HS	50 to 140 ns	108.4	108.0	110.4	109.0	109.7	108.7	108.9	132.5	135.3	135.1
MT_ON	0 to 20 ns	3.5	3.0	3.6	3.9	3.4	3.9	4.1	5.3	4.5	6.4
MT_OFF	0 to 20 ns	3.3	2.7	3.0	2.4	2.7	3.0	2.7	2.9	2.5	3.5
VCCUV+pa	7.4 to 9.6 V	8.4	8.4	8.4	8.4	8.4	8.4	8.4	8.4	8.4	8.4
VCCUV-pa	7 to 9.4 V	8.2	8.2	8.2	8.2	8.2	8.2	8.2	8.1	8.2	8.2
VBSUV+pa	7.5 to 9.7 V	8.5	8.5	8.5	8.5	8.5	8.4	8.5	8.5	8.5	8.5
VBSUV-pa	7 to 9.4 V	8.3	8.2	8.3	8.2	8.3	8.2	8.2	8.2	8.3	8.2
IQDD1	0 to 30 uA	0.050	0.048	0.047	0.049	0.047	0.050	0.051	0.051	0.053	0.049
IQCC1	0 to 340 uA	99.4	100.3	99.7	100.3	99.6	99.5	100.2	105.5	105.7	105.2
IQBS1	0 to 230 uA	57.1	57.4	56.1	56.3	56.0	56.1	56.7	55.8	56.8	56.1
D_IQDD1	0 to 3 uA	0.003	0	0.006	0.002	0.003	0.003	0.001	0	0.003	0.001
D_IQCC1	0 to 30 uA	0.125	0.125	0.125	0.063	0.125	0	0.063	0.063	0.125	0.375
D_IQBS1	0 to 20 uA	0.188	0	0.188	0.188	0.063	0.313	0.063	0.188	0.063	0.125

**INTERNATIONAL RECTIFIER  
EL SEGUNDO, CALIFORNIA**

CUSTOMER: IR  
 DEVICE : RIC7113L4  
 SPEC NO. : DOC:71-9837-17 REV:06 (c)SZ  
 JOB NO. : NA

L.D.C. : 800819  
 LOT NO: B7607  
 DATE : 01/13/2000  
 Location: PRE ELECTRICALS

TESTS	LIMITS	41	42	43	44	45	46	47	48	49	50
CONT_OPN	0 to 0	0	0	0	0	0	0	0	0	0	0
DIOD_SHT	0 to 0	0	0	0	0	0	0	0	0	0	0
V_MAX	425 to 990 V	N/A	N/A	N/A	N/A	N/A	N/A	N/A	N/A	N/A	N/A
I_LEAK	-1 to 50 uA	1.6	1.4	1.7	1.4	2.2	1.4	1.8	1.7	1.5	1.3
IQDD0	0 to 30 uA	0.038	0.039	0.038	0.040	0.039	0.039	0.039	0.040	0.038	0.040
IQCC0	0 to 340 uA	95.8	97.3	96.3	96.9	95.9	95.2	98.1	96.1	102.4	94.6
IQBS0	0 to 230 uA	73.1	72.8	72.7	71.8	72.6	71.7	73.4	79.6	77.9	77.9
IHINO	0 to 1 uA	0.013	0.013	0.013	0.013	0.013	0.013	0.013	0.013	0.013	0.012
ILINO	0 to 1 uA	0.013	0.013	0.013	0.013	0.013	0.013	0.013	0.013	0.013	0.012
ISD0	0 to 1 uA	0.012	0.013	0.012	0.013	0.012	0.012	0.013	0.012	0.012	0.012
IQDD1	0 to 30 uA	0.050	0.053	0.049	0.047	0.048	0.049	0.051	0.050	0.051	0.052
IQCC1	0 to 340 uA	104.4	105.6	105.0	105.2	104.6	103.5	106.9	104.9	112.8	102.2
IQBS1	0 to 230 uA	56.8	55.6	55.8	54.9	56.0	55.3	56.1	63.0	61.4	62.1
IHIN1	0 to 40 uA	24.4	24.8	24.6	24.6	24.4	24.2	25.1	24.4	24.2	23.8
ILIN1	0 to 40 uA	24.9	25.1	25.0	25.1	24.8	24.6	25.5	24.6	24.5	23.8
ISD1	0 to 40 uA	24.5	24.7	24.6	24.7	24.4	24.2	25.1	24.3	24.1	23.6
ILO+	2 to 5 A	2.5	2.4	2.5	2.5	2.5	2.5	2.5	2.7	2.7	2.9
ILO-	2 to 5 A	3.0	2.9	2.9	2.9	2.9	2.9	2.9	3.1	3.2	3.2
IHO+	2 to 5 A	2.4	2.3	2.3	2.3	2.3	2.3	2.3	2.6	2.6	2.7
IHO-	2 to 5 A	3.2	3.1	3.1	3.1	3.2	3.1	3.1	3.4	3.4	3.4
FN_15/15	1 to 1	1	1	1	1	1	1	1	1	1	1
VOH_LS	0 to 1.2 V	0.613	0.617	0.613	0.620	0.613	0.610	0.618	0.579	0.586	0.578
VOL_LS	-0.01 to 0.1 V	0	0	0	0	0	0	0	0	0	0
VOL_HS	-0.01 to 0.1 V	0	0	0	0	0	0	0	0	0	0
VOH_HS	0 to 1.2 V	0.590	0.595	0.590	0.595	0.591	0.590	0.599	0.559	0.565	0.558
Vth+HS	6 to 9.5 V	8.5	8.4	8.4	8.5	8.4	8.5	8.5	8.5	8.4	8.5
Vth-HS	6 to 9.5 V	6.8	6.8	6.8	6.8	6.8	6.8	6.8	7.0	6.9	7.0
Vth+LS	6 to 9.5 V	8.4	8.4	8.4	8.4	8.4	8.4	8.4	8.5	8.4	8.5
Vth-LS	6 to 9.5 V	6.8	6.7	6.8	6.7	6.8	6.8	6.8	6.9	6.9	7.0
Vth+SD	6 to 9.5 V	8.4	8.4	8.5	8.4	8.4	8.4	8.5	8.4	8.4	8.5
TON_LS	50 to 200 ns	144.1	149.8	148.1	149.5	145.3	148.6	147.8	124.5	125.9	120.9
TOFF_LS	50 to 200 ns	128.3	132.6	130.2	132.9	129	132.8	131.4	111.5	113.9	108.5
TR_LS	2 to 35 ns	15.5	15.6	15.5	15.2	15.5	15.3	15.7	15.7	15.4	15.1
TF_LS	2 to 25 ns	6.8	6.9	6.8	6.8	6.7	6.7	6.7	7.0	7.2	6.3
TON_HS	50 to 200 ns	138.6	143.7	141.2	144.3	140.6	143.9	143.5	118.8	120.1	116.0
TOFF_HS	50 to 200 ns	124.6	129.3	127	130.1	127	130.4	129.1	107.9	109.2	106.2
TR_HS	2 to 35 ns	19.2	19.2	19.1	19.3	19.2	19.1	19.2	18.6	18.9	18.4
TF_HS	2 to 25 ns	13.8	13.6	12.8	13.4	13.9	14.0	13.7	12.5	13.4	13.1
TSD_LS	50 to 140 ns	129.2	132.2	130.3	133.7	129.6	132.8	131.4	111.1	112.9	108.2
TSD_HS	50 to 140 ns	133.5	138.0	135.7	138.9	136.0	138.7	137.7	113.6	114.4	112.0
MT_ON	0 to 20 ns	5.5	6.1	6.9	5.3	4.7	4.7	4.3	5.7	5.8	4.9
MT_OFF	0 to 20 ns	3.7	3.3	3.2	2.8	2.0	2.4	2.3	3.6	4.6	2.2
VCCUV+pa	7.4 to 9.6 V	8.4	8.4	8.4	8.4	8.4	8.4	8.4	8.4	8.5	8.4
VCCUV-pa	7 to 9.4 V	8.2	8.2	8.2	8.2	8.2	8.2	8.2	8.2	8.2	8.2
VBSUV+pa	7.5 to 9.7 V	8.5	8.5	8.5	8.5	8.5	8.5	8.5	8.5	8.5	8.5
VBSUV-pa	7 to 9.4 V	8.2	8.2	8.2	8.2	8.2	8.2	8.2	8.3	8.3	8.3
IQDD1	0 to 30 uA	0.049	0.048	0.052	0.049	0.046	0.051	0.049	0.049	0.049	0.053
IQCC1	0 to 340 uA	104.3	105.6	104.9	105.2	104.6	103.4	106.9	104.9	112.5	102.3
IQBS1	0 to 230 uA	56.4	55.7	55.8	55.1	56.4	55.0	56.1	63.0	61.6	62.1
D_IQDD1	0 to 3 uA	0.001	0.004	0.003	0.003	0.001	0.002	0.002	0	0.001	0
D_IQCC1	0 to 30 uA	0.125	0	0.063	0	0	0.125	0.063	0	0.313	0.125
D_IQBS1	0 to 20 uA	0.375	0.125	0	0.125	0.438	0.250	0.063	0	0.188	0.063

**INTERNATIONAL RECTIFIER  
EL SEGUNDO, CALIFORNIA**

CUSTOMER: IR  
 DEVICE : RIC7113L4  
 SPEC NO. : DOC:71-9837-17 REV:06 (c)SZ  
 JOB NO. : NA

L.D.C. : 800819  
 LOT NO: B7607  
 DATE : 01/13/2000  
 Location: PRE ELECTRICALS

TESTS	LIMITS	51	52	53	54	55	56	57	58	59	60
CONT_OPN	0 to 0	0	0	0	0	0	0	0	0	0	0
DIOD_SHT	0 to 0	0	0	0	0	0	0	0	0	0	0
V_MAX	425 to 990 V	N/A	N/A	N/A	N/A	N/A	N/A	N/A	N/A	N/A	N/A
I_LEAK	-1 to 50 uA	1.3	1.7	1.4	1.3	1.7	1.5	1.2	1.4	1.6	1.7
IQDD0	0 to 30 uA	0.038	0.035	0.039	0.041	0.041	0.039	0.040	0.041	0.039	0.039
IQCC0	0 to 340 uA	100.1	101.1	98.4	95.5	95.5	101.9	92.3	91.3	91.0	92.3
IQBS0	0 to 230 uA	77.4	77.4	78.2	77.6	77.6	78.9	69.9	69.6	70.1	68.7
IHIN0	0 to 1 uA	0.013	0.013	0.013	0.013	0.013	0.013	0.012	0.012	0.012	0.012
ILIN0	0 to 1 uA	0.013	0.013	0.013	0.013	0.013	0.013	0.012	0.012	0.012	0.012
ISD0	0 to 1 uA	0.012	0.012	0.012	0.012	0.012	0.012	0.012	0.012	0.012	0.012
IQDD1	0 to 30 uA	0.049	0.051	0.575	0.052	0.048	0.050	0.051	0.049	0.050	0.049
IQCC1	0 to 340 uA	105.1	105.8	106.4	103.7	103.4	106.5	100.3	98.9	98.7	100.1
IQBS1	0 to 230 uA	61.1	61.2	61.8	61.6	61.7	63.8	54.9	54.3	54.9	53.9
IHIN1	0 to 40 uA	24.2	24.2	24.5	24.0	24.1	24.4	23.3	23.2	23.0	23.1
ILIN1	0 to 40 uA	24.5	24.4	24.8	24.3	24.3	24.7	23.5	23.5	23.3	23.5
ISD1	0 to 40 uA	24.3	24.2	24.4	24.0	24.1	24.4	23.3	23.2	22.9	23.2
ILO+	2 to 5 A	2.8	2.7	2.7	2.8	2.8	2.7	2.6	2.6	2.5	2.6
ILO-	2 to 5 A	3.2	3.1	3.1	3.2	3.2	3.1	3.0	3.0	3.0	3.0
IHO+	2 to 5 A	2.6	2.6	2.5	2.6	2.6	2.5	2.3	2.4	2.4	2.4
IHO-	2 to 5 A	3.4	3.4	3.4	3.4	3.4	3.3	3.2	3.2	3.3	3.3
FN_15/15	1 to 1	1	1	1	1	1	1	1	1	1	1
VOH_LS	0 to 1.2 V	0.591	0.585	0.592	0.580	0.581	0.593	0.590	0.592	0.594	0.595
VOL_LS	-0.01 to 0.1 V	0	0	0	0	0	0	0	0	0	0
VOL_HS	-0.01 to 0.1 V	0	0	0	0	0	0	0	0	0	0
VOH_HS	0 to 1.2 V	0.572	0.564	0.567	0.561	0.554	0.571	0.567	0.568	0.570	0.572
Vth+HS	6 to 9.5 V	8.4	8.4	8.4	8.5	8.5	8.5	8.4	8.4	8.4	8.4
Vth-HS	6 to 9.5 V	6.9	6.9	6.9	7.0	7.0	6.9	6.8	6.8	6.8	6.8
Vth+LS	6 to 9.5 V	8.4	8.4	8.4	8.4	8.5	8.4	8.4	8.4	8.4	8.4
Vth-LS	6 to 9.5 V	6.9	6.9	6.9	7.0	6.9	6.9	6.8	6.8	6.8	6.8
Vth+SD	6 to 9.5 V	8.4	8.4	8.4	8.4	8.4	8.4	8.4	8.4	8.4	8.4
TON_LS	50 to 200 ns	126.8	126.5	127.0	124.1	124.7	126.2	138.8	138.5	137.7	138.0
TOFF_LS	50 to 200 ns	113.7	114.0	113.7	111.2	111.3	113.4	120.0	120.5	120.0	119.9
TR_LS	2 to 35 ns	15.0	15.3	15.3	15.3	15.0	15.1	15.5	15.4	15.5	15.6
TF_LS	2 to 25 ns	6.9	7.0	7.0	6.8	6.7	7.1	7.4	7.1	7.5	7.3
TON_HS	50 to 200 ns	120.1	120.5	120.3	117.0	117.9	120.4	135.3	135.4	134.9	134.1
TOFF_HS	50 to 200 ns	109.2	108.9	108.8	107.2	107.5	109.2	121.0	120.9	120.6	120.3
TR_HS	2 to 35 ns	18.5	18.6	18.5	18.4	18.4	18.9	18.8	18.7	18.6	18.8
TF_HS	2 to 25 ns	13.2	13.2	13.2	12.1	12.2	12.4	8.0	8.4	8.5	9.1
TSD_LS	50 to 140 ns	112.9	113.0	113.0	110.6	111.6	112.8	121.0	121.1	121.2	120.5
TSD_HS	50 to 140 ns	114.4	114.5	114.7	112.0	112.9	115.7	130.8	129.6	129.8	129.0
MT_ON	0 to 20 ns	6.7	5.9	6.7	7.1	6.9	5.8	3.5	3.1	2.7	3.9
MT_OFF	0 to 20 ns	4.5	5.0	4.8	4.0	3.8	4.2	1.0	0.390	0.600	0.380
VCCUV+pa	7.4 to 9.6 V	8.4	8.4	8.5	8.5	8.4	8.5	8.4	8.4	8.4	8.4
VCCUV-pa	7 to 9.4 V	8.2	8.2	8.2	8.2	8.2	8.2	8.1	8.2	8.1	8.2
VBSUV+pa	7.5 to 9.7 V	8.5	8.5	8.5	8.5	8.6	8.5	8.5	8.4	8.5	8.5
VBSUV-pa	7 to 9.4 V	8.3	8.3	8.3	8.3	8.3	8.3	8.2	8.2	8.2	8.2
IQDD1	0 to 30 uA	0.049	0.051	0.463	0.051	0.049	0.050	0.051	0.051	0.051	0.051
IQCC1	0 to 340 uA	105.0	105.7	106.4	103.8	103.6	106.5	100.5	99.2	98.8	100.1
IQBS1	0 to 230 uA	61.0	61.4	61.8	61.8	61.4	63.9	54.8	54.1	54.9	54.0
D_IQDD1	0 to 3 uA	0	0	0.112	0.001	0.001	0	0	0.002	0	0.003
D_IQCC1	0 to 30 uA	0.125	0.125	0.063	0.063	0.188	0	0.188	0.250	0.063	0.063
D_IQBS1	0 to 20 uA	0.063	0.188	0.063	0.250	0.313	0.063	0.125	0.188	0.063	0.125

**INTERNATIONAL RECTIFIER  
EL SEGUNDO, CALIFORNIA**

CUSTOMER: IR  
 DEVICE : RIC7113L4  
 SPEC NO. : DOC:71-9837-17 REV:06 (c)SZ  
 JOB NO. : NA

L.D.C. : 800819  
 LOT NO: B7607  
 DATE : 01/13/2000  
 Location: PRE ELECTRICALS

TESTS	LIMITS	61	62	63	64	65	66	67	68	69	70
CONT_OPN	0 to 0	0	0	0	0	0	0	0	0	0	0
DIOD_SHT	0 to 0	0	0	0	0	0	0	0	0	0	0
V_MAX	425 to 990 V	N/A	N/A	N/A	N/A	N/A	N/A	N/A	N/A	N/A	N/A
I_LEAK	-1 to 50 uA	1.0	1.4	1.5	1.8	0.993	1.3	1.3	1.7	1.7	1.2
IQDD0	0 to 30 uA	0.038	0.039	0.038	0.039	0.039	0.039	0.039	0.039	0.038	0.039
IQCC0	0 to 340 uA	91.7	92.1	92.0	98.1	99.1	97.6	98.2	97.0	97.1	96.5
IQBS0	0 to 230 uA	69.1	69.7	70.1	81.1	81.4	79.6	80.0	80.6	79.9	78.4
IHIN0	0 to 1 uA	0.012	0.012	0.012	0.013	0.013	0.013	0.013	0.013	0.013	0.013
ILIN0	0 to 1 uA	0.012	0.012	0.012	0.013	0.013	0.013	0.013	0.013	0.013	0.013
ISD0	0 to 1 uA	0.012	0.012	0.012	0.013	0.013	0.012	0.012	0.012	0.012	0.012
IQDD1	0 to 30 uA	0.050	0.051	0.050	0.051	0.051	0.052	0.051	0.050	0.052	0.049
IQCC1	0 to 340 uA	99.4	100.1	99.6	106.7	107.6	106.3	106.2	105.4	105.5	105.0
IQBS1	0 to 230 uA	53.9	54.3	54.9	64.0	64.1	62.9	63.0	63.6	63.5	62.4
IHIN1	0 to 40 uA	23.1	23.2	23.3	24.9	25.2	24.6	24.4	24.5	24.5	24.3
ILIN1	0 to 40 uA	23.4	23.4	23.5	25.0	25.5	25.0	24.7	24.8	24.7	24.6
ISD1	0 to 40 uA	23.1	23.2	23.3	24.8	25.2	24.6	24.4	24.5	24.4	24.3
ILO+	2 to 5 A	2.5	2.5	2.6	2.8	2.8	2.8	2.8	2.9	2.9	2.9
ILO-	2 to 5 A	3.0	3.0	3.0	3.2	3.2	3.3	3.2	3.2	3.3	3.2
IHO+	2 to 5 A	2.3	2.3	2.3	2.6	2.6	2.6	2.6	2.6	2.6	2.6
IHO-	2 to 5 A	3.2	3.2	3.2	3.4	3.4	3.5	3.5	3.4	3.5	3.5
FN_15/15	1 to 1	1	1	1	1	1	1	1	1	1	1
VOH_LS	0 to 1.2 V	0.593	0.592	0.595	0.579	0.576	0.576	0.584	0.582	0.576	0.578
VOL_LS	-0.01 to 0.1 V	0	0	0	0	0	0	0	0	0	0
VOL_HS	-0.01 to 0.1 V	0	0	0	0	0	0	0	0	0	0
VOH_HS	0 to 1.2 V	0.573	0.570	0.573	0.557	0.552	0.554	0.561	0.561	0.553	0.553
Vth+HS	6 to 9.5 V	8.4	8.4	8.5	8.4	8.5	8.5	8.5	8.5	8.5	8.5
Vth-HS	6 to 9.5 V	6.8	6.8	6.8	6.9	7.0	7.0	7.0	7.0	7.0	7.0
Vth+LS	6 to 9.5 V	8.4	8.4	8.4	8.4	8.4	8.4	8.4	8.4	8.5	8.5
Vth-LS	6 to 9.5 V	6.8	6.7	6.8	6.9	6.9	6.9	6.9	6.9	6.9	7.0
Vth+SD	6 to 9.5 V	8.4	8.4	8.4	8.4	8.5	8.5	8.5	8.5	8.5	8.5
TON_LS	50 to 200 ns	138.0	137.6	138.6	117.1	117.9	116.7	114.1	118.0	116.7	117.7
TOFF_LS	50 to 200 ns	119.6	119.6	120.3	103.3	103.4	102.6	100.5	103.5	102.7	103.4
TR_LS	2 to 35 ns	15.5	15.5	15.3	15.4	15.7	15.4	15.4	15.8	15.9	15.7
TF_LS	2 to 25 ns	7.4	7.3	7.0	6.9	6.7	6.9	6.6	6.7	7.2	6.5
TON_HS	50 to 200 ns	135.1	134.5	136.0	114.0	113.4	113.6	111.1	113.7	112.7	113.5
TOFF_HS	50 to 200 ns	120.3	120.0	120.9	103.0	102.8	103.0	101.1	103.1	102.6	103.2
TR_HS	2 to 35 ns	18.8	18.9	18.5	18.0	18.2	17.9	17.8	18.5	18.2	18.4
TF_HS	2 to 25 ns	8.3	8.4	8.8	11.1	12.8	10.2	9.6	11.2	11.1	12.1
TSD_LS	50 to 140 ns	120.9	120.2	121.2	103.2	103.9	102.7	100.7	103.5	102.5	105.0
TSD_HS	50 to 140 ns	129.6	128.9	129.2	108.9	108.5	108.8	107.3	109.4	109.5	109.9
MT_ON	0 to 20 ns	2.9	3.1	2.6	3.2	4.6	3.1	3.0	4.3	4.0	4.3
MT_OFF	0 to 20 ns	0.660	0.480	0.610	0.270	0.600	0.410	0.620	0.420	0.080	0.200
VCCUV+pa	7.4 to 9.6 V	8.4	8.4	8.4	8.5	8.4	8.5	8.4	8.4	8.5	8.5
VCCUV-pa	7 to 9.4 V	8.1	8.2	8.1	8.2	8.2	8.2	8.2	8.2	8.2	8.2
VBSUV+pa	7.5 to 9.7 V	8.4	8.5	8.5	8.5	8.6	8.5	8.5	8.5	8.6	8.6
VBSUV-pa	7 to 9.4 V	8.2	8.2	8.2	8.3	8.3	8.3	8.3	8.3	8.3	8.3
IQDD1	0 to 30 uA	0.050	0.051	0.049	0.046	0.049	0.049	0.049	0.051	0.051	0.048
IQCC1	0 to 340 uA	99.5	100.4	99.5	106.8	107.6	106.3	106.0	105.4	105.4	105.0
IQBS1	0 to 230 uA	53.8	54.3	55.0	64.1	63.9	63.0	63.3	63.6	63.4	62.2
D_IQDD1	0 to 3 uA	0	0	0.001	0.005	0.002	0.003	0.001	0	0.001	0.001
D_IQCC1	0 to 30 uA	0.125	0.250	0.125	0.063	0.063	0	0.188	0	0.125	0
D_IQBS1	0 to 20 uA	0.063	0.063	0.063	0.125	0.125	0.125	0.250	0	0.063	0.188

**INTERNATIONAL RECTIFIER  
EL SEGUNDO, CALIFORNIA**

CUSTOMER: IR  
 DEVICE : RIC7113L4  
 SPEC NO. : DOC:71-9837-17 REV:06 (c)SZ  
 JOB NO. : NA

L.D.C. : 800819  
 LOT NO: B7607  
 DATE : 01/13/2000  
 Location: PRE ELECTRICALS

TESTS	LIMITS	71	72	73					
CONT_OPN	0 to 0	0	0	0					
DIOD_SHT	0 to 0	0	0	0					
V_MAX	425 to 990 V	N/A	N/A	N/A					
I_LEAK	-1 to 50 uA	1.9	1.6	1.1					
IQDD0	0 to 30 uA	0.039	0.038	0.041					
IQCC0	0 to 340 uA	98.9	97.6	97.6					
IQBS0	0 to 230 uA	79.3	79.0	78.5					
IHIN0	0 to 1 uA	0.013	0.013	0.013					
ILIN0	0 to 1 uA	0.013	0.013	0.013					
ISD0	0 to 1 uA	0.013	0.012	0.012					
IQDD1	0 to 30 uA	0.052	0.049	0.051					
IQCC1	0 to 340 uA	107.2	105.6	106.4					
IQBS1	0 to 230 uA	62.9	62.6	61.9					
IHIN1	0 to 40 uA	24.7	24.6	24.5					
ILIN1	0 to 40 uA	25.2	24.8	24.9					
ISD1	0 to 40 uA	24.9	24.5	24.5					
ILO+	2 to 5 A	2.9	2.7	2.8					
ILO-	2 to 5 A	3.2	3.2	3.2					
IHO+	2 to 5 A	2.6	2.6	2.6					
IHO-	2 to 5 A	3.5	3.4	3.4					
FN_15/15	1 to 1	1	1	1					
VOH_LS	0 to 1.2 V	0.576	0.575	0.578					
VOL_LS	-0.01 to 0.1 V	0	0	0					
VOL_HS	-0.01 to 0.1 V	0	0	0					
VOH_HS	0 to 1.2 V	0.553	0.553	0.556					
Vth+HS	6 to 9.5 V	8.5	8.5	8.5					
Vth-HS	6 to 9.5 V	7.0	7.0	7.0					
Vth+LS	6 to 9.5 V	8.5	8.5	8.5					
Vth-LS	6 to 9.5 V	6.9	6.9	6.9					
Vth+SD	6 to 9.5 V	8.4	8.4	8.4					
TON_LS	50 to 200 ns	117.2	121.1	117.4					
TOFF_LS	50 to 200 ns	102.9	106.6	103.2					
TR_LS	2 to 35 ns	15.6	15.2	15.4					
TF_LS	2 to 25 ns	7.0	6.8	6.9					
TON_HS	50 to 200 ns	113.4	117.9	113.9					
TOFF_HS	50 to 200 ns	102.5	105.9	103.1					
TR_HS	2 to 35 ns	17.9	17.8	18.1					
TF_HS	2 to 25 ns	11.5	11.3	10.4					
TSD_LS	50 to 140 ns	102.9	106.7	103.0					
TSD_HS	50 to 140 ns	108.6	112.3	108.7					
MT_ON	0 to 20 ns	3.8	3.2	3.5					
MT_OFF	0 to 20 ns	0.390	0.710	0.050					
VCCUV+pa	7.4 to 9.6 V	8.4	8.3	8.5					
VCCUV-pa	7 to 9.4 V	8.1	8.0	8.2					
VBSUV+pa	7.5 to 9.7 V	8.6	8.5	8.5					
VBSUV-pa	7 to 9.4 V	8.3	8.3	8.3					
IQDD1	0 to 30 uA	0.048	0.049	0.049					
IQCC1	0 to 340 uA	107.2	105.8	106.5					
IQBS1	0 to 230 uA	62.6	62.2	62.1					
D_IQDD1	0 to 3 uA	0.004	0	0.001					
D_IQCC1	0 to 30 uA	0	0.188	0.125					
D_IQBS1	0 to 20 uA	0.313	0.438	0.250					

INTERNATIONAL RECTIFIER  
EL SEGUNDO, CALIFORNIA

## Appendix B2

### Post Burnin / Pre Irradiation Electricals



**INTERNATIONAL RECTIFIER  
EL SEGUNDO, CALIFORNIA  
TEST SUMMARY**

CUSTOMER: IR  
 DEVICE : RIC7113L4  
 SPEC NO. : DOC:71-9837-17 REV:06 (c)SZ  
 JOB NO. : NA

L.D.C. : 0002  
 LOT NO: B7607R  
 DATE : 2/14/00  
 Location: PRE IRRADIATION

<b>Total Units Tested: 72</b>	<b>Total units Passed: 72</b>	<b>Electrical Yield: %100.00</b>
-------------------------------	-------------------------------	----------------------------------

TESTS	Failed Qty	% Loss	Failed Serial Numbers
CONT_OPN			
DIOD_SHT			
V_MAX			
I_LEAK			
IQDD0			
IQCC0			
IQBS0			
IHIN0			
ILIN0			
ISD0			
IQDD1			
IQCC1			
IQBS1			
IHIN1			
ILIN1			
ISD1			
ILO+			
ILO-			
IHO+			
IHO-			
FN_15/15			
VOH_LS			
VOL_LS			
VOL_HS			
VOH_HS			
Vth+HS			
Vth+LS			
Vth+SD			
TON_LS			
TOFF_LS			
TR_LS			
TF_LS			
TON_HS			
TOFF_HS			
TR_HS			
TF_HS			
TSD_LS			
TSD_HS			
MT_ON			
MT_OFF			
VCCUV+pa			
VCCUV-pa			
VBSUV+pa			
VBSUV-pa			
IQDD1			
IQCC1			
IQBS1			
D_IQDD1			
D_IQCC1			
D_IQBS1			

**INTERNATIONAL RECTIFIER  
EL SEGUNDO, CALIFORNIA**

CUSTOMER: IR  
 DEVICE : RIC7113L4  
 SPEC NO. : DOC:71-9837-17 REV:06 (c)SZ  
 JOB NO. : NA

L.D.C. : 0002  
 LOT NO: B7607R  
 DATE : 2/14/00  
 Location: PRE IRRADIATION

TESTS	LIMITS	1	2	3	4	5	6	7	8	9	10
CONT_OPN	0 to 0	0	0	0	0	0	0	0	0	0	0
DIOD_SHT	0 to 0	0	0	0	0	0	0	0	0	0	0
V_MAX	425 to 990 V	N/A	N/A	N/A	N/A	N/A	N/A	N/A	N/A	N/A	N/A
I_LEAK	-1 to 50 uA	1.5	1.8	2.0	1.8	2.0	1.6	1.4	2.0	1.4	1.7
IQDD0	0 to 150 uA	0.044	0.038	0.036	0.039	0.036	0.038	0.038	0.039	0.036	0.039
IQCC0	0 to 1000 uA	90.9	89.9	90.1	90.6	116.9	90.3	90.3	89.8	93.4	94.3
IQBS0	0 to 230 uA	69.6	69.7	68.3	68.4	68.0	69.1	68.9	68.8	76.0	77.6
IHIN0	0 to 1 uA	0.016	0.012	0.013	0.013	0.013	0.012	0.012	0.013	0.013	0.013
ILIN0	0 to 1 uA	0.016	0.012	0.013	0.013	0.013	0.013	0.012	0.013	0.013	0.013
ISD0	0 to 1 uA	0.016	0.012	0.012	0.012	0.013	0.012	0.012	0.012	0.013	0.013
IQDD1	0 to 150 uA	0.052	0.051	0.050	0.051	0.050	0.052	0.051	0.051	0.051	0.049
IQCC1	0 to 1000 uA	98.8	97.7	97.9	98.5	129.0	98.2	98.4	97.8	101.8	103.0
IQBS1	0 to 230 uA	53.5	53.6	52.8	52.8	51.6	53.4	52.8	53.1	59.4	60.9
IHIN1	0 to 40 uA	23.8	23.7	23.9	23.7	24.5	23.7	23.7	23.8	24.7	24.6
ILIN1	0 to 40 uA	24.0	24.0	24.2	24.1	24.7	24.0	24.0	23.9	25.0	25.0
ISD1	0 to 40 uA	23.9	23.7	23.9	23.8	24.3	23.7	23.7	23.8	24.7	24.7
ILO+	2 to 5 A	2.8	2.8	2.7	2.7	2.7	2.8	2.7	2.7	3.1	3.1
ILO-	2 to 5 A	3.2	3.2	3.2	3.2	3.1	3.3	3.2	3.2	3.5	3.5
IHO+	2 to 5 A	2.5	2.5	2.5	2.5	2.4	2.6	2.5	2.5	2.9	2.9
IHO-	2 to 5 A	3.5	3.5	3.5	3.4	3.3	3.5	3.5	3.4	3.7	3.8
FN_15/15	1 to 1	1	1	1	1	1	1	1	1	1	1
VOH_LS	0 to 1.2 V	0.490	0.495	0.497	0.502	0.503	0.497	0.500	0.498	0.462	0.463
VOL_LS	-0.01 to 0.1 V	0	0	0	0	0	0	0	0	0	0
VOL_HS	-0.01 to 0.1 V	0	0	0	0	0	0	0	0	0	0
VOH_HS	0 to 1.2 V	0.467	0.474	0.473	0.476	0.481	0.475	0.477	0.476	0.445	0.442
Vth+HS	6 to 9.5 V	8.3	8.3	8.3	8.3	8.3	8.3	8.3	8.3	8.4	8.4
Vth-HS	6 to 9.5 V	6.8	6.7	6.7	6.7	6.7	6.7	6.7	6.7	7.0	7.0
Vth+LS	6 to 9.5 V	8.2	8.2	8.3	8.3	8.3	8.3	8.3	8.3	8.4	8.4
Vth-LS	6 to 9.5 V	6.7	6.7	6.7	6.7	6.7	6.7	6.7	6.7	7.0	7.0
Vth+SD	6 to 9.5 V	8.3	8.2	8.3	8.3	8.3	8.3	8.3	8.3	8.4	8.4
TON_LS	50 to 200 ns	132.0	133.7	134.2	135.6	144.9	131.7	134.5	134.8	114.0	111.3
TOFF_LS	50 to 200 ns	120.3	121.6	122.3	122.8	129	120.3	122.7	122.7	106.7	105.1
TR_LS	2 to 35 ns	7.7	8.0	8.2	8.4	7.9	7.7	7.7	8.1	8.2	8.7
TF_LS	2 to 25 ns	6.0	5.8	5.8	5.8	6.4	6.1	6.0	5.8	6.2	5.7
TON_HS	50 to 200 ns	125.2	126.0	127.0	127.6	135.7	125.0	127.4	127.4	107.2	104.3
TOFF_HS	50 to 200 ns	111.7	112.5	112.6	113.5	120.5	111.1	113.7	113.1	98.4	95.5
TR_HS	2 to 35 ns	10.4	10.4	10.1	10.3	10.1	10.4	10.5	10.3	10.9	10.7
TF_HS	2 to 25 ns	10.8	10.7	10.4	10.5	9.4	10.5	11.0	10.8	10.2	10.4
TSD_LS	50 to 140 ns	120.0	121.5	122.1	122.4	128.6	120.0	122.5	122.3	106.3	104.5
TSD_HS	50 to 140 ns	115.1	115.5	116.4	117.0	124.2	114.9	116.6	116.4	101.2	98.5
MT_ON	0 to 20 ns	6.8	7.7	7.2	8.0	9.3	6.6	7.1	7.4	6.8	7.0
MT_OFF	0 to 20 ns	8.7	9.1	9.7	9.4	8.6	9.1	9.0	9.6	8.3	9.6
VCCUV+pa	7.4 to 9.6 V	8.5	8.6	8.5	8.5	8.5	8.5	8.5	8.6	8.5	8.6
VCCUV-pa	7 to 9.4 V	8.3	8.3	8.3	8.3	8.3	8.2	8.3	8.3	8.3	8.3
VBSUV+pa	7.5 to 9.7 V	8.6	8.6	8.4	8.4	8.6	8.5	8.6	8.6	8.6	8.6
VBSUV-pa	7 to 9.4 V	8.3	8.3	8.2	8.2	8.3	8.3	8.3	8.3	8.3	8.3
IQDD1	0 to 30 uA	0.048	0.051	0.049	0.049	0.049	0.050	0.052	0.051	0.049	0.050
IQCC1	0 to 340 uA	98.6	98.3	98.4	98.6	129.0	98.3	97.9	97.8	101.9	102.9
IQBS1	0 to 230 uA	53.8	53.9	52.5	52.8	51.8	53.5	53.3	53.1	59.1	60.6
D_IQDD1	0 to 3 uA	0.004	0	0	0.003	0.001	0.002	0	0	0.002	0
D_IQCC1	0 to 30 uA	0.250	0.625	0.500	0.125	0	0.125	0.500	0.063	0.125	0.063
D_IQBS1	0 to 20 uA	0.250	0.375	0.250	0	0.125	0.125	0.438	0	0.250	0.250

**INTERNATIONAL RECTIFIER  
EL SEGUNDO, CALIFORNIA**

CUSTOMER: IR  
 DEVICE : RIC7113L4  
 SPEC NO. : DOC:71-9837-17 REV:06 (c)SZ  
 JOB NO. : NA

L.D.C. : 0002  
 LOT NO: B7607R  
 DATE : 2/14/00  
 Location: PRE IRRADIATION

TESTS	LIMITS	11	12	13	14	15	16	17	18	19	20
CONT_OPN	0 to 0	0	0	0	0	0	0	0	0	0	0
DIOD_SHT	0 to 0	0	0	0	0	0	0	0	0	0	0
V_MAX	425 to 990 V	N/A	N/A	N/A	N/A	N/A	N/A	N/A	N/A	N/A	N/A
I_LEAK	-1 to 50 uA	2.2	1.7	1.8	1.9	1.4	2.0	1.7	1.9	1.8	1.7
IQDD0	0 to 150 uA	0.036	0.036	0.038	0.036	0.037	0.037	0.036	0.037	0.039	0.038
IQCC0	0 to 1000 uA	93.4	92.7	93.3	93.9	93.8	94.1	93.8	93.4	89.7	90.1
IQBS0	0 to 230 uA	76.7	77.6	76.6	78.0	76.4	79.0	77.3	78.3	67.0	69.3
IHIN0	0 to 1 uA	0.013	0.013	0.013	0.013	0.013	0.013	0.013	0.013	0.013	0.013
ILIN0	0 to 1 uA	0.013	0.013	0.013	0.013	0.014	0.013	0.013	0.013	0.013	0.013
ISD0	0 to 1 uA	0.013	0.012	0.013	0.013	0.013	0.013	0.013	0.012	0.012	0.013
IQDD1	0 to 150 uA	0.053	0.051	0.050	0.053	0.051	0.050	0.051	0.052	0.051	0.053
IQCC1	0 to 1000 uA	101.8	101.4	101.8	102.6	102.3	102.9	102.6	101.8	98.2	98.8
IQBS1	0 to 230 uA	59.4	60.6	59.5	61.1	59.4	62.1	60.4	60.8	50.9	52.5
IHIN1	0 to 40 uA	24.7	24.5	24.9	24.6	24.7	24.8	24.8	24.5	23.7	24.4
ILIN1	0 to 40 uA	25.0	24.8	25.2	24.9	25.1	25.1	25.1	25.0	24.0	24.6
ISD1	0 to 40 uA	24.7	24.4	24.8	24.6	24.8	24.8	24.7	24.5	23.7	24.3
ILO+	2 to 5 A	3.1	3.1	3.0	3.1	3.0	3.1	3.1	3.1	2.6	2.6
ILO-	2 to 5 A	3.5	3.5	3.4	3.5	3.4	3.5	3.5	3.5	3.1	3.1
IHO+	2 to 5 A	2.8	2.9	2.8	2.9	2.8	2.9	2.9	2.9	2.4	2.4
IHO-	2 to 5 A	3.7	3.8	3.6	3.7	3.7	3.8	3.7	3.8	3.3	3.3
FN_15/15	1 to 1	1	1	1	1	1	1	1	1	1	1
VOH_LS	0 to 1.2 V	0.468	0.467	0.477	0.466	0.479	0.463	0.467	0.463	0.520	0.518
VOL_LS	-0.01 to 0.1 V	0	0	0	0	0	0	0	0	0	0
VOL_HS	-0.01 to 0.1 V	0	0	0	0	0	0	0	0	0	0
VOH_HS	0 to 1.2 V	0.449	0.445	0.456	0.443	0.458	0.443	0.445	0.446	0.495	0.499
Vth+HS	6 to 9.5 V	8.4	8.3	8.3	8.4	8.3	8.4	8.4	8.3	8.3	8.3
Vth-HS	6 to 9.5 V	7.0	7.0	6.9	7.0	6.9	7.0	7.0	7.0	6.7	6.7
Vth+LS	6 to 9.5 V	8.4	8.3	8.3	8.3	8.3	8.3	8.4	8.3	8.3	8.3
Vth-LS	6 to 9.5 V	6.9	6.9	6.8	6.9	6.8	6.9	6.9	6.9	6.7	6.7
Vth+SD	6 to 9.5 V	8.4	8.3	8.3	8.3	8.3	8.4	8.4	8.3	8.3	8.3
TON_LS	50 to 200 ns	113.5	111.5	118.7	110.5	118.6	110.2	112.4	111.3	133.8	134.4
TOFF_LS	50 to 200 ns	106.9	105.1	109.7	105.2	109.5	104.7	105.8	104.9	116.3	117.4
TR_LS	2 to 35 ns	8.4	8.6	8.1	8.3	8.0	8.3	7.9	8.7	7.3	8.0
TF_LS	2 to 25 ns	6.1	5.9	6.1	5.4	6.4	5.8	6.0	5.9	6.4	6.1
TON_HS	50 to 200 ns	106.8	104.0	112.3	104.0	112.0	103.3	105.6	104.1	128.8	130.1
TOFF_HS	50 to 200 ns	97.9	96.0	101.5	95.7	101.9	94.9	97.1	95.2	113.6	115.0
TR_HS	2 to 35 ns	10.8	11.0	10.6	10.9	10.5	10.9	10.8	10.7	10.6	10.9
TF_HS	2 to 25 ns	10.1	10.4	10.2	10.2	10.3	10.2	10.3	10.3	8.5	8.5
TSD_LS	50 to 140 ns	106.7	104.3	109.0	104.7	108.7	103.8	105.7	104.6	116.2	117.3
TSD_HS	50 to 140 ns	101.1	97.8	104.7	98.0	104.9	97.5	99.4	98.3	117.6	118.5
MT_ON	0 to 20 ns	6.7	7.5	6.5	6.5	6.6	6.9	6.7	7.2	5.0	4.3
MT_OFF	0 to 20 ns	9.0	9.1	8.2	9.6	7.6	9.8	8.7	9.7	2.8	2.4
VCCUV+pa	7.4 to 9.6 V	8.5	8.5	8.5	8.5	8.5	8.5	8.5	8.5	8.5	8.5
VCCUV-pa	7 to 9.4 V	8.3	8.3	8.3	8.3	8.3	8.2	8.3	8.3	8.2	8.3
VBSUV+pa	7.5 to 9.7 V	8.6	8.6	8.6	8.5	8.6	8.6	8.6	8.6	8.6	8.5
VBSUV-pa	7 to 9.4 V	8.3	8.3	8.3	8.2	8.3	8.3	8.3	8.3	8.3	8.3
IQDD1	0 to 30 uA	0.049	0.052	0.049	0.051	0.048	0.051	0.050	0.049	0.049	0.049
IQCC1	0 to 340 uA	102.2	101.1	101.5	102.4	101.9	102.9	102.3	102.0	97.9	98.7
IQBS1	0 to 230 uA	59.6	60.6	59.3	61.3	59.3	61.9	60.3	60.5	51.1	52.5
D_IQDD1	0 to 3 uA	0.004	0.001	0.001	0.001	0.003	0.001	0	0.003	0.001	0.004
D_IQCC1	0 to 30 uA	0.438	0.313	0.313	0.188	0.438	0.063	0.375	0.188	0.250	0.125
D_IQBS1	0 to 20 uA	0.250	0.063	0.188	0.188	0.125	0.250	0.188	0.250	0.188	0

**INTERNATIONAL RECTIFIER  
EL SEGUNDO, CALIFORNIA**

CUSTOMER: IR  
 DEVICE : RIC7113L4  
 SPEC NO. : DOC:71-9837-17 REV:06 (c)SZ  
 JOB NO. : NA

L.D.C. : 0002  
 LOT NO: B7607R  
 DATE : 2/14/00  
 Location: PRE IRRADIATION

TESTS	LIMITS	21	22	23	25	26	27	28	29	30	31
CONT_OPN	0 to 0	0	0	0	0	0	0	0	0	0	0
DIOD_SHT	0 to 0	0	0	0	0	0	0	0	0	0	0
V_MAX	425 to 990 V	N/A	N/A	N/A	N/A	N/A	N/A	N/A	N/A	N/A	N/A
I_LEAK	-1 to 50 uA	1.8	1.5	1.9	1.8	1.4	1.8	1.6	1.6	1.7	1.6
IQDD0	0 to 150 uA	0.041	0.036	0.036	0.038	0.036	0.038	0.037	0.036	0.037	0.039
IQCC0	0 to 1000 uA	90.7	89.8	89.3	91.2	91.0	89.6	91.8	91.9	91.6	90.9
IQBS0	0 to 230 uA	68.8	67.4	67.3	69.3	68.4	67.4	72.9	73.8	72.7	73.1
IHIN0	0 to 1 uA	0.013	0.012	0.013	0.013	0.013	0.013	0.013	0.013	0.013	0.013
ILIN0	0 to 1 uA	0.013	0.013	0.013	0.013	0.013	0.013	0.013	0.013	0.013	0.013
ISD0	0 to 1 uA	0.012	0.012	0.012	0.013	0.013	0.012	0.013	0.012	0.012	0.012
IQDD1	0 to 150 uA	0.049	0.049	0.049	0.050	0.050	0.050	0.049	0.051	0.049	0.051
IQCC1	0 to 1000 uA	99.3	97.9	97.8	99.5	99.4	97.9	100.1	100.1	99.9	99.1
IQBS1	0 to 230 uA	52.3	51.4	51.0	52.0	51.4	51.3	56.9	57.8	56.3	57.0
IHIN1	0 to 40 uA	24.4	23.7	23.9	24.3	24.4	23.8	24.2	23.9	24.0	24.0
ILIN1	0 to 40 uA	24.7	24.0	24.0	24.7	24.7	24.0	24.6	24.4	24.4	24.5
ISD1	0 to 40 uA	24.3	23.8	23.9	24.4	24.4	23.8	24.3	24.0	24.1	24.1
ILO+	2 to 5 A	2.6	2.6	2.6	2.6	2.7	2.6	2.9	3.0	2.9	2.9
ILO-	2 to 5 A	3.1	3.1	3.1	3.1	3.1	3.1	3.3	3.4	3.3	3.3
IHO+	2 to 5 A	2.4	2.4	2.4	2.4	2.5	2.4	2.7	2.7	2.7	2.7
IHO-	2 to 5 A	3.3	3.3	3.3	3.3	3.3	3.3	3.5	3.6	3.5	3.6
FN_15/15	1 to 1	1	1	1	1	1	1	1	1	1	1
VOH_LS	0 to 1.2 V	0.515	0.519	0.520	0.520	0.516	0.521	0.504	0.491	0.498	0.499
VOL_LS	-0.01 to 0.1 V	0	0	0	0	0	0	0	0	0	0
VOL_HS	-0.01 to 0.1 V	0	0	0	0	0	0	0	0	0	0
VOH_HS	0 to 1.2 V	0.497	0.495	0.495	0.499	0.496	0.496	0.477	0.471	0.475	0.474
Vth+HS	6 to 9.5 V	8.3	8.3	8.3	8.3	8.3	8.3	8.3	8.4	8.3	8.4
Vth-HS	6 to 9.5 V	6.7	6.7	6.7	6.7	6.7	6.7	6.9	6.9	6.8	6.9
Vth+LS	6 to 9.5 V	8.3	8.3	8.3	8.3	8.3	8.3	8.3	8.3	8.3	8.4
Vth-LS	6 to 9.5 V	6.7	6.7	6.7	6.7	6.7	6.7	6.8	6.9	6.8	6.9
Vth+SD	6 to 9.5 V	8.3	8.3	8.3	8.3	8.3	8.3	8.3	8.4	8.3	8.4
TON_LS	50 to 200 ns	133.0	132.6	135.0	131.4	133.6	134.3	118.1	112.2	118.3	117.6
TOFF_LS	50 to 200 ns	115.9	114.8	117.4	114.5	116.5	116.7	105.3	101.1	105.2	104.5
TR_LS	2 to 35 ns	7.5	7.4	7.0	7.9	7.8	7.6	7.3	7.1	7.4	7.4
TF_LS	2 to 25 ns	6.4	6.3	6.3	6.5	6.3	6.4	6.3	6.5	6.5	6.4
TON_HS	50 to 200 ns	129.1	127.0	129.7	128.1	130.3	128.8	113.2	107.3	113.1	112.5
TOFF_HS	50 to 200 ns	114.4	111.8	114.2	113.2	115.5	113.7	101.4	96.7	100.6	100.2
TR_HS	2 to 35 ns	10.7	10.5	10.8	10.7	10.9	10.5	10.8	10.9	10.9	11.0
TF_HS	2 to 25 ns	8.3	8.7	8.9	8.2	8.3	8.6	8.4	8.1	8.5	8.5
TSD_LS	50 to 140 ns	115.3	114.6	116.8	113.8	115.6	115.9	104.1	100.0	104.5	103.4
TSD_HS	50 to 140 ns	117.1	116.4	118.1	116.3	118.5	116.8	104.2	99.3	104.0	103.3
MT_ON	0 to 20 ns	3.9	5.6	5.3	3.2	3.3	5.5	5.0	4.9	5.1	5.1
MT_OFF	0 to 20 ns	1.4	2.9	3.2	1.3	0.960	3.0	4.0	4.4	4.7	4.4
VCCUV+pa	7.4 to 9.6 V	8.5	8.5	8.5	8.5	8.5	8.5	8.5	8.5	8.4	8.5
VCCUV-pa	7 to 9.4 V	8.3	8.2	8.3	8.2	8.3	8.3	8.2	8.2	8.2	8.2
VBSUV+pa	7.5 to 9.7 V	8.5	8.5	8.5	8.6	8.5	8.5	8.5	8.5	8.5	8.6
VBSUV-pa	7 to 9.4 V	8.3	8.3	8.3	8.3	8.2	8.3	8.3	8.3	8.3	8.3
IQDD1	0 to 30 uA	0.049	0.051	0.052	0.049	0.052	0.050	0.052	0.053	0.053	0.050
IQCC1	0 to 340 uA	99.2	98.3	97.8	99.4	99.4	97.4	100.3	100.1	99.9	99.2
IQBS1	0 to 230 uA	52.2	51.3	51.1	52.2	51.7	51.2	56.6	57.8	56.2	57.2
D_IQDD1	0 to 3 uA	0	0.001	0.003	0	0.002	0	0.003	0.002	0.003	0.001
D_IQCC1	0 to 30 uA	0.063	0.438	0	0.125	0	0.438	0.188	0.063	0.063	0.125
D_IQBS1	0 to 20 uA	0.125	0.125	0.125	0.188	0.250	0.063	0.313	0	0.063	0.188

**INTERNATIONAL RECTIFIER  
EL SEGUNDO, CALIFORNIA**

CUSTOMER: IR  
 DEVICE : RIC7113L4  
 SPEC NO. : DOC:71-9837-17 REV:06 (c)SZ  
 JOB NO. : NA

L.D.C. : 0002  
 LOT NO: B7607R  
 DATE : 2/14/00  
 Location: PRE IRRADIATION

TESTS	LIMITS	32	33	34	35	36	37	38	39	40	41
CONT_OPN	0 to 0	0	0	0	0	0	0	0	0	0	0
DIOD_SHT	0 to 0	0	0	0	0	0	0	0	0	0	0
V_MAX	425 to 990 V	N/A	N/A	N/A	N/A	N/A	N/A	N/A	N/A	N/A	N/A
I_LEAK	-1 to 50 uA	2.1	1.8	1.5	1.6	2.0	1.5	1.9	2.0	1.7	1.7
IQDD0	0 to 150 uA	0.036	0.036	0.038	0.038	0.036	0.036	0.038	0.038	0.036	0.037
IQCC0	0 to 1000 uA	91.6	91.2	91.8	91.1	91.1	91.6	96.8	96.6	96.9	96.0
IQBS0	0 to 230 uA	73.5	72.4	73.0	72.2	72.9	73.0	72.9	73.3	74.0	73.4
IHINO	0 to 1 uA	0.013	0.013	0.013	0.013	0.013	0.013	0.013	0.013	0.013	0.013
ILINO	0 to 1 uA	0.013	0.013	0.013	0.013	0.013	0.013	0.013	0.013	0.013	0.013
ISD0	0 to 1 uA	0.012	0.012	0.013	0.012	0.013	0.013	0.013	0.013	0.013	0.013
IQDD1	0 to 150 uA	0.049	0.052	0.053	0.049	0.051	0.049	0.049	0.051	0.051	0.049
IQCC1	0 to 1000 uA	100.1	99.5	100.2	99.1	99.2	99.9	105.2	105.4	105.4	104.8
IQBS1	0 to 230 uA	57.4	55.9	56.8	56.2	56.4	56.9	56.0	56.0	56.5	56.9
IHIN1	0 to 40 uA	24.2	24.1	24.1	23.9	24.1	24.3	24.8	24.8	24.9	24.7
ILIN1	0 to 40 uA	24.5	24.4	24.5	24.2	24.4	24.6	25.0	25.1	25.3	25.2
ISD1	0 to 40 uA	24.2	24.1	24.2	24.0	24.2	24.3	24.7	24.7	24.9	24.8
ILO+	2 to 5 A	2.9	2.9	2.9	2.9	2.9	2.9	2.6	2.6	2.6	2.6
ILO-	2 to 5 A	3.3	3.3	3.3	3.3	3.3	3.4	3.0	3.0	3.0	3.0
IHO+	2 to 5 A	2.7	2.7	2.6	2.7	2.7	2.7	2.4	2.4	2.4	2.4
IHO-	2 to 5 A	3.5	3.5	3.5	3.5	3.5	3.5	3.2	3.2	3.2	3.2
FN_15/15	1 to 1	1	1	1	1	1	1	1	1	1	1
VOH_LS	0 to 1.2 V	0.497	0.499	0.498	0.499	0.499	0.498	0.619	0.616	0.609	0.611
VOL_LS	-0.01 to 0.1 V	0	0	0	0	0	0	0	0	0	0
VOL_HS	-0.01 to 0.1 V	0	0	0	0	0	0	0	0	0	0
VOH_HS	0 to 1.2 V	0.478	0.477	0.480	0.476	0.479	0.477	0.599	0.590	0.592	0.587
Vth+HS	6 to 9.5 V	8.4	8.3	8.3	8.3	8.4	8.3	8.4	8.5	8.4	8.5
Vth-HS	6 to 9.5 V	6.9	6.8	6.8	6.9	6.9	6.8	6.8	6.8	6.8	6.8
Vth+LS	6 to 9.5 V	8.3	8.3	8.3	8.3	8.3	8.3	8.4	8.4	8.4	8.4
Vth-LS	6 to 9.5 V	6.8	6.8	6.8	6.8	6.8	6.8	6.8	6.8	6.7	6.8
Vth+SD	6 to 9.5 V	8.3	8.3	8.3	8.3	8.3	8.3	8.4	8.4	8.4	8.4
TON_LS	50 to 200 ns	115.1	117.3	118.0	117.5	117.2	117.3	144.0	143.1	145.6	143.2
TOFF_LS	50 to 200 ns	102.6	105.0	103.9	105.4	104.3	104.3	125.9	125.6	126.5	125.3
TR_LS	2 to 35 ns	7.5	7.5	7.3	7.0	7.3	7.5	7.8	7.5	7.7	7.8
TF_LS	2 to 25 ns	6.2	6.3	6.2	6.2	6.3	6.0	6.3	6.5	6.8	6.5
TON_HS	50 to 200 ns	110.5	112.8	112.9	113.0	112.5	112.6	137.4	136.9	138.6	136.5
TOFF_HS	50 to 200 ns	98.8	101.2	100.9	101.4	100.8	100.7	122.3	122.0	122.4	121.1
TR_HS	2 to 35 ns	11.0	11.0	11.0	10.9	11.1	10.9	10.6	10.6	10.3	10.6
TF_HS	2 to 25 ns	8.4	8.4	8.1	8.5	8.0	8.4	9.3	8.8	9.2	9.1
TSD_LS	50 to 140 ns	102.1	103.9	103.2	104.1	103.3	103.2	125.3	125.0	127.1	124.4
TSD_HS	50 to 140 ns	102.6	104.2	104.3	104.7	103.9	104.0	126.5	126.4	127.5	125.5
MT_ON	0 to 20 ns	4.6	4.6	5.1	4.5	4.8	4.8	6.6	6.3	7.0	6.7
MT_OFF	0 to 20 ns	3.8	3.8	3.0	4.0	3.5	3.6	3.6	3.6	4.1	4.2
VCCUV+pa	7.4 to 9.6 V	8.5	8.5	8.5	8.5	8.5	8.5	8.5	8.5	8.5	8.5
VCCUV-pa	7 to 9.4 V	8.2	8.3	8.2	8.3	8.3	8.2	8.2	8.3	8.3	8.2
VBSUV+pa	7.5 to 9.7 V	8.6	8.6	8.5	8.6	8.5	8.5	8.6	8.6	8.6	8.6
VBSUV-pa	7 to 9.4 V	8.3	8.3	8.2	8.3	8.2	8.3	8.3	8.3	8.3	8.3
IQDD1	0 to 30 uA	0.051	0.049	0.049	0.051	0.050	0.053	0.048	0.049	0.049	0.051
IQCC1	0 to 340 uA	100.1	99.4	100.1	99.3	99.5	100.1	105.4	105.2	105.3	104.6
IQBS1	0 to 230 uA	57.1	56.1	56.2	56.1	56.0	56.8	55.8	56.4	56.9	56.8
D_IQDD1	0 to 3 uA	0.002	0.003	0.004	0.002	0.001	0.003	0.001	0.002	0.001	0.002
D_IQCC1	0 to 30 uA	0	0.063	0.063	0.250	0.313	0.125	0.188	0.188	0.188	0.250
D_IQBS1	0 to 20 uA	0.313	0.188	0.563	0.063	0.438	0.125	0.188	0.438	0.375	0.188

**INTERNATIONAL RECTIFIER  
EL SEGUNDO, CALIFORNIA**

CUSTOMER: IR  
 DEVICE : RIC7113L4  
 SPEC NO. : DOC:71-9837-17 REV:06 (c)SZ  
 JOB NO. : NA

L.D.C. : 0002  
 LOT NO: B7607R  
 DATE : 2/14/00  
 Location: PRE IRRADIATION

TESTS	LIMITS	42	43	44	45	46	47	48	49	50	51
CONT_OPN	0 to 0	0	0	0	0	0	0	0	0	0	0
DIOD_SHT	0 to 0	0	0	0	0	0	0	0	0	0	0
V_MAX	425 to 990 V	N/A	N/A	N/A	N/A	N/A	N/A	N/A	N/A	N/A	N/A
I_LEAK	-1 to 50 uA	2.0	1.6	2.2	1.7	1.6	1.7	1.9	1.4	1.3	1.7
IQDD0	0 to 150 uA	0.033	0.040	0.038	0.038	0.039	0.038	0.039	0.037	0.039	0.038
IQCC0	0 to 1000 uA	97.6	96.5	96.8	96.5	95.1	98.1	96.5	101.4	94.3	100.4
IQBS0	0 to 230 uA	73.1	72.9	72.1	73.1	71.6	73.5	79.4	77.8	77.9	77.6
IHIN0	0 to 1 uA	0.013	0.013	0.013	0.013	0.013	0.013	0.013	0.013	0.013	0.013
ILIN0	0 to 1 uA	0.013	0.013	0.013	0.013	0.013	0.013	0.013	0.013	0.013	0.013
ISD0	0 to 1 uA	0.013	0.013	0.013	0.013	0.012	0.013	0.013	0.013	0.012	0.012
IQDD1	0 to 150 uA	0.050	0.049	0.051	0.051	0.048	0.048	0.052	0.051	0.051	0.053
IQCC1	0 to 1000 uA	105.9	104.9	105.6	104.8	103.1	106.6	104.4	112.4	101.6	105.1
IQBS1	0 to 230 uA	55.9	56.3	55.4	56.7	55.1	56.5	63.0	61.6	62.0	61.4
IHIN1	0 to 40 uA	25.0	24.7	24.8	24.7	24.2	25.2	24.5	24.3	23.8	24.3
ILIN1	0 to 40 uA	25.2	25.0	25.3	24.9	24.6	25.5	24.7	24.6	23.8	24.5
ISD1	0 to 40 uA	24.9	24.7	24.9	24.6	24.3	25.1	24.4	24.2	23.6	24.3
ILO+	2 to 5 A	2.5	2.6	2.5	2.6	2.6	2.5	2.9	2.9	2.9	2.9
ILO-	2 to 5 A	3.0	3.0	2.9	3.0	3.0	2.9	3.3	3.3	3.4	3.3
IHO+	2 to 5 A	2.3	2.4	2.3	2.4	2.4	2.3	2.7	2.6	2.7	2.6
IHO-	2 to 5 A	3.2	3.2	3.1	3.2	3.2	3.2	3.5	3.5	3.5	3.5
FN_15/15	1 to 1	1	1	1	1	1	1	1	1	1	1
VOH_LS	0 to 1.2 V	0.618	0.616	0.616	0.615	0.611	0.622	0.581	0.589	0.582	0.595
VOL_LS	-0.01 to 0.1 V	0	0	0	0	0	0	0	0	0	0
VOL_HS	-0.01 to 0.1 V	0	0	0	0	0	0	0	0	0	0
VOH_HS	0 to 1.2 V	0.597	0.593	0.595	0.590	0.593	0.603	0.560	0.567	0.561	0.573
Vth+HS	6 to 9.5 V	8.4	8.4	8.5	8.4	8.4	8.5	8.5	8.4	8.5	8.4
Vth-HS	6 to 9.5 V	6.8	6.8	6.8	6.8	6.8	6.8	7.0	6.9	7.0	6.9
Vth+LS	6 to 9.5 V	8.4	8.4	8.4	8.4	8.4	8.4	8.5	8.4	8.5	8.4
Vth-LS	6 to 9.5 V	6.7	6.8	6.7	6.8	6.7	6.7	6.9	6.9	7.0	6.9
Vth+SD	6 to 9.5 V	8.4	8.4	8.4	8.4	8.4	8.4	8.4	8.4	8.5	8.4
TON_LS	50 to 200 ns	147.9	145.3	148.2	144.1	147.2	145.9	122.0	123.9	118.9	123.7
TOFF_LS	50 to 200 ns	128.5	126.8	129.7	126.2	128.8	127	109.7	111.7	106.0	111.0
TR_LS	2 to 35 ns	7.4	7.6	7.7	7.9	7.6	7.3	7.9	7.9	7.5	7.5
TF_LS	2 to 25 ns	6.4	7.1	6.7	6.5	6.2	6.5	6.4	6.7	6.1	6.9
TON_HS	50 to 200 ns	140.8	138.0	141.5	137.8	140.9	139.7	115.9	117.4	112.9	117.0
TOFF_HS	50 to 200 ns	125.3	122.2	125.7	122.6	125.4	124.0	105.6	106.0	104.0	106.0
TR_HS	2 to 35 ns	10.3	10.5	10.3	10.4	10.5	10.4	10.6	10.5	10.9	10.3
TF_HS	2 to 25 ns	8.9	9.0	9.4	9.3	9.0	9.1	8.8	9.6	8.2	9.4
TSD_LS	50 to 140 ns	127.9	126.6	128.8	126.3	128.5	126.7	108.8	110.9	104.9	110.4
TSD_HS	50 to 140 ns	129.2	127.1	129.8	127.4	130.0	128.6	109.0	109.2	107.2	109.4
MT_ON	0 to 20 ns	7.1	7.3	6.7	6.4	6.3	6.2	6.1	6.5	6.0	6.7
MT_OFF	0 to 20 ns	3.2	4.7	4.0	3.6	3.4	3.1	4.1	5.6	2.0	5.0
VCCUV+pa	7.4 to 9.6 V	8.5	8.5	8.5	8.5	8.5	8.5	8.5	8.5	8.5	8.5
VCCUV-pa	7 to 9.4 V	8.3	8.2	8.2	8.3	8.2	8.2	8.3	8.3	8.3	8.3
VBSUV+pa	7.5 to 9.7 V	8.5	8.5	8.6	8.6	8.6	8.6	8.6	8.6	8.6	8.6
VBSUV-pa	7 to 9.4 V	8.3	8.3	8.3	8.3	8.3	8.3	8.3	8.3	8.3	8.3
IQDD1	0 to 30 uA	0.048	0.051	0.049	0.049	0.049	0.051	0.050	0.050	0.053	0.049
IQCC1	0 to 340 uA	105.8	104.8	105.5	104.9	103.4	106.4	104.6	112.7	101.9	105.0
IQBS1	0 to 230 uA	55.6	55.6	55.3	56.3	55.1	56.0	63.2	61.6	61.8	61.3
D_IQDD1	0 to 3 uA	0.002	0.001	0.002	0.001	0	0.003	0.002	0	0.002	0.003
D_IQCC1	0 to 30 uA	0.125	0.188	0.063	0.188	0.313	0.250	0.188	0.313	0.313	0.125
D_IQBS1	0 to 20 uA	0.250	0.688	0.063	0.438	0.063	0.500	0.188	0	0.250	0.063

**INTERNATIONAL RECTIFIER  
EL SEGUNDO, CALIFORNIA**

CUSTOMER: IR  
 DEVICE : RIC7113L4  
 SPEC NO. : DOC:71-9837-17 REV:06 (c)SZ  
 JOB NO. : NA

L.D.C. : 0002  
 LOT NO: B7607R  
 DATE : 2/14/00  
 Location: PRE IRRADIATION

TESTS	LIMITS	52	53	54	55	56	57	58	59	60	61
CONT_OPN	0 to 0	0	0	0	0	0	0	0	0	0	0
DIOD_SHT	0 to 0	0	0	0	0	0	0	0	0	0	0
V_MAX	425 to 990 V	N/A	N/A	N/A	N/A	N/A	N/A	N/A	N/A	N/A	N/A
I_LEAK	-1 to 50 uA	1.9	1.7	1.7	1.5	2.1	1.8	1.7	1.6	1.8	1.7
IQDD0	0 to 150 uA	0.038	0.037	0.039	0.039	0.038	0.036	0.036	0.034	0.037	0.040
IQCC0	0 to 1000 uA	100.2	98.0	95.4	95.3	102.1	92.5	91.4	91.1	92.5	92.0
IQBS0	0 to 230 uA	77.5	77.6	77.6	77.8	79.0	69.9	69.5	70.4	68.9	69.3
IHIN0	0 to 1 uA	0.013	0.013	0.013	0.013	0.013	0.013	0.013	0.012	0.012	0.012
ILIN0	0 to 1 uA	0.013	0.013	0.013	0.013	0.013	0.013	0.013	0.012	0.012	0.012
ISD0	0 to 1 uA	0.013	0.013	0.012	0.012	0.013	0.012	0.012	0.012	0.012	0.012
IQDD1	0 to 150 uA	0.050	1.1	0.052	0.050	0.049	0.049	0.050	0.051	0.052	0.048
IQCC1	0 to 1000 uA	106.4	105.6	103.4	103.3	106.8	100.6	99.3	98.9	100.4	100.0
IQBS1	0 to 230 uA	61.4	61.7	61.7	61.7	64.1	54.7	54.3	54.9	53.8	54.5
IHIN1	0 to 40 uA	24.3	24.4	24.0	24.1	24.5	23.4	23.4	23.2	23.3	23.3
ILIN1	0 to 40 uA	24.4	24.7	24.4	24.3	24.7	23.6	23.5	23.5	23.6	23.6
ISD1	0 to 40 uA	24.3	24.4	24.1	24.1	24.5	23.4	23.3	23.1	23.4	23.3
ILO+	2 to 5 A	2.9	2.9	2.9	2.9	2.8	2.7	2.7	2.6	2.6	2.7
ILO-	2 to 5 A	3.3	3.3	3.3	3.3	3.3	3.1	3.1	3.1	3.1	3.1
IHO+	2 to 5 A	2.6	2.6	2.7	2.7	2.6	2.4	2.4	2.5	2.4	2.5
IHO-	2 to 5 A	3.5	3.5	3.5	3.5	3.5	3.3	3.3	3.3	3.3	3.3
FN_15/15	1 to 1	1	1	1	1	1	1	1	1	1	1
VOH_LS	0 to 1.2 V	0.585	0.596	0.582	0.581	0.593	0.593	0.593	0.593	0.596	0.595
VOL_LS	-0.01 to 0.1 V	0	0	0	0	0	0	0	0	0	0
VOL_HS	-0.01 to 0.1 V	0	0	0	0	0	0	0	0	0	0
VOH_HS	0 to 1.2 V	0.566	0.571	0.563	0.560	0.572	0.571	0.570	0.572	0.571	0.571
Vth+HS	6 to 9.5 V	8.4	8.4	8.5	8.5	8.5	8.4	8.4	8.4	8.4	8.4
Vth-HS	6 to 9.5 V	6.9	6.9	7.0	7.0	6.9	6.8	6.8	6.8	6.8	6.8
Vth+LS	6 to 9.5 V	8.4	8.4	8.4	8.5	8.4	8.4	8.4	8.4	8.4	8.4
Vth-LS	6 to 9.5 V	6.9	6.9	6.9	6.9	6.9	6.8	6.7	6.8	6.7	6.7
Vth+SD	6 to 9.5 V	8.4	8.4	8.4	8.4	8.4	8.4	8.4	8.4	8.4	8.4
TON_LS	50 to 200 ns	124.0	123.5	121.2	121.8	124.0	137.1	137.3	136.4	137.1	136.8
TOFF_LS	50 to 200 ns	111.3	110.8	109.1	109.2	111.2	116.9	117.1	116.5	116.5	116.7
TR_LS	2 to 35 ns	8.2	7.9	7.7	7.9	8.2	7.4	7.3	7.5	7.2	7.4
TF_LS	2 to 25 ns	6.7	6.9	6.7	7.0	7.0	6.6	6.2	6.7	6.6	6.7
TON_HS	50 to 200 ns	117.4	116.7	114.4	115.0	117.9	132.5	132.5	132.2	131.5	132.2
TOFF_HS	50 to 200 ns	106.1	105.7	104.6	104.9	106.6	117.4	117.3	117.3	117.1	116.8
TR_HS	2 to 35 ns	10.4	10.5	10.8	10.6	10.4	10.7	10.8	10.6	10.9	10.7
TF_HS	2 to 25 ns	9.2	9.2	8.9	8.6	8.6	8.1	8.2	8.0	8.0	8.2
TSD_LS	50 to 140 ns	110.2	110.3	108.5	108.7	110.2	117.3	117.0	116.8	117.2	116.7
TSD_HS	50 to 140 ns	109.1	109.2	108.1	108.5	109.4	121.6	121.2	120.9	121.1	120.7
MT_ON	0 to 20 ns	6.6	6.8	6.9	6.8	6.1	4.6	4.7	4.2	5.6	4.6
MT_OFF	0 to 20 ns	5.2	5.0	4.6	4.3	4.6	0.530	0.190	0.850	0.530	0.100
VCCUV+pa	7.4 to 9.6 V	8.5	8.5	8.6	8.5	8.5	8.5	8.5	8.5	8.5	8.5
VCCUV-pa	7 to 9.4 V	8.3	8.3	8.3	8.2	8.3	8.2	8.2	8.2	8.2	8.2
VBSUV+pa	7.5 to 9.7 V	8.6	8.6	8.6	8.6	8.6	8.5	8.5	8.5	8.6	8.5
VBSUV-pa	7 to 9.4 V	8.3	8.3	8.3	8.3	8.3	8.2	8.2	8.3	8.3	8.2
IQDD1	0 to 30 uA	0.051	1.1	0.051	0.050	0.049	0.050	0.049	0.049	0.049	0.050
IQCC1	0 to 340 uA	106.6	105.6	103.6	103.2	106.9	100.3	99.1	98.9	100.3	99.9
IQBS1	0 to 230 uA	61.5	61.7	61.6	61.3	64.4	54.8	54.4	54.9	54.1	54.0
D_IQDD1	0 to 3 uA	0	0.001	0	0	0	0.001	0	0.003	0.003	0.002
D_IQCC1	0 to 30 uA	0.250	0.063	0.250	0.063	0.125	0.250	0.250	0.063	0.063	0.063
D_IQBS1	0 to 20 uA	0.063	0	0.063	0.375	0.375	0.125	0.188	0	0.375	0.500

**INTERNATIONAL RECTIFIER  
EL SEGUNDO, CALIFORNIA**

CUSTOMER: IR  
 DEVICE : RIC7113L4  
 SPEC NO. : DOC:71-9837-17 REV:06 (c)SZ  
 JOB NO. : NA

L.D.C. : 0002  
 LOT NO: B7607R  
 DATE : 2/14/00  
 Location: PRE IRRADIATION

TESTS	LIMITS	62	63	64	65	66	67	68	69	70	71
CONT_OPN	0 to 0	0	0	0	0	0	0	0	0	0	0
DIOD_SHT	0 to 0	0	0	0	0	0	0	0	0	0	0
V_MAX	425 to 990 V	N/A	N/A	N/A	N/A	N/A	N/A	N/A	N/A	N/A	N/A
I_LEAK	-1 to 50 uA	1.9	1.8	1.7	1.9	1.2	1.7	1.6	1.6	1.5	1.4
IQDD0	0 to 150 uA	0.035	0.038	0.036	0.038	0.037	0.036	0.038	0.036	0.036	0.038
IQCC0	0 to 1000 uA	92.6	92.2	98.2	98.2	97.8	98.3	97.1	97.4	96.8	98.6
IQBS0	0 to 230 uA	70.2	70.2	81.3	80.8	79.8	80.1	81.1	80.4	78.9	79.4
IHIN0	0 to 1 uA	0.013	0.012	0.013	0.013	0.013	0.013	0.013	0.013	0.013	0.013
ILIN0	0 to 1 uA	0.013	0.012	0.013	0.013	0.013	0.013	0.013	0.013	0.013	0.013
ISD0	0 to 1 uA	0.012	0.012	0.013	0.013	0.013	0.013	0.013	0.013	0.013	0.013
IQDD1	0 to 150 uA	0.051	0.053	0.051	0.051	0.049	0.053	0.050	0.052	0.051	0.051
IQCC1	0 to 1000 uA	100.4	100.1	106.3	106.7	106.3	106.2	105.4	105.8	105.1	107.4
IQBS1	0 to 230 uA	54.9	55.1	63.8	63.6	63.0	63.3	63.8	63.6	62.5	62.6
IHIN1	0 to 40 uA	23.5	23.5	24.9	24.9	24.8	24.6	24.6	24.7	24.5	24.9
ILIN1	0 to 40 uA	23.6	23.7	25.0	25.1	25.1	24.8	24.9	24.9	24.8	25.3
ISD1	0 to 40 uA	23.4	23.5	24.9	24.9	24.7	24.5	24.7	24.6	24.5	25.0
ILO+	2 to 5 A	2.7	2.6	2.9	2.9	2.9	2.9	2.9	2.9	2.9	2.9
ILO-	2 to 5 A	3.1	3.1	3.3	3.3	3.3	3.3	3.3	3.3	3.3	3.3
IHO+	2 to 5 A	2.4	2.4	2.7	2.7	2.7	2.7	2.7	2.7	2.7	2.7
IHO-	2 to 5 A	3.3	3.3	3.5	3.5	3.5	3.5	3.5	3.5	3.5	3.5
FN_15/15	1 to 1	1	1	1	1	1	1	1	1	1	1
VOH_LS	0 to 1.2 V	0.592	0.594	0.580	0.583	0.578	0.583	0.584	0.574	0.577	0.574
VOL_LS	-0.01 to 0.1 V	0	0	0	0	0	0	0	0	0	0
VOL_HS	-0.01 to 0.1 V	0	0	0	0	0	0	0	0	0	0
VOH_HS	0 to 1.2 V	0.571	0.574	0.562	0.564	0.555	0.564	0.563	0.553	0.554	0.556
Vth+HS	6 to 9.5 V	8.4	8.5	8.4	8.5	8.5	8.5	8.5	8.5	8.5	8.5
Vth-HS	6 to 9.5 V	6.8	6.8	6.9	7.0	6.9	7.0	7.0	7.0	7.0	7.0
Vth+LS	6 to 9.5 V	8.4	8.4	8.4	8.4	8.4	8.4	8.4	8.5	8.5	8.4
Vth-LS	6 to 9.5 V	6.7	6.8	6.9	6.9	6.9	6.9	6.9	6.9	6.9	6.9
Vth+SD	6 to 9.5 V	8.4	8.4	8.4	8.4	8.4	8.5	8.4	8.5	8.5	8.4
TON_LS	50 to 200 ns	136.5	137.4	115.6	115.2	115.9	112.9	116.4	115.4	116.4	115.7
TOFF_LS	50 to 200 ns	116.8	117.7	100.8	100.7	100.8	98.5	101.5	101.0	102.0	101.0
TR_LS	2 to 35 ns	7.4	7.4	7.7	7.2	7.5	7.6	7.3	7.2	7.1	7.5
TF_LS	2 to 25 ns	6.3	6.5	6.0	5.9	6.3	6.4	6.2	6.2	6.2	5.9
TON_HS	50 to 200 ns	131.7	133.4	110.8	109.9	111.4	108.7	111.0	110.0	110.7	110.7
TOFF_HS	50 to 200 ns	117.1	118.0	100.3	99.7	100.3	98.5	100.6	100.4	100.8	100.8
TR_HS	2 to 35 ns	10.8	10.9	10.9	11.0	10.9	11.1	11.0	11.1	11.0	11.0
TF_HS	2 to 25 ns	8.1	8.3	7.6	7.8	7.6	7.5	7.7	7.7	7.7	7.4
TSD_LS	50 to 140 ns	116.7	117.6	100.0	99.8	100.1	97.5	100.8	100.2	100.9	100.6
TSD_HS	50 to 140 ns	120.6	121.6	103.1	102.2	103.3	101.1	103.9	103.1	103.5	102.9
MT_ON	0 to 20 ns	4.8	4.0	4.8	5.3	4.6	4.3	5.4	5.4	5.6	5.0
MT_OFF	0 to 20 ns	0.270	0.290	0.480	0.950	0.520	0.020	0.910	0.610	1.2	0.190
VCCUV+pa	7.4 to 9.6 V	8.5	8.5	8.6	8.5	8.5	8.5	8.5	8.6	8.6	8.5
VCCUV-pa	7 to 9.4 V	8.2	8.2	8.3	8.3	8.3	8.3	8.3	8.3	8.3	8.2
VBSUV+pa	7.5 to 9.7 V	8.5	8.5	8.6	8.6	8.6	8.6	8.6	8.6	8.6	8.6
VBSUV-pa	7 to 9.4 V	8.3	8.3	8.3	8.3	8.3	8.3	8.3	8.3	8.4	8.3
IQDD1	0 to 30 uA	0.048	0.049	0.051	0.053	0.050	0.049	0.051	0.051	0.049	0.051
IQCC1	0 to 340 uA	100.6	99.5	106.6	106.8	106.1	106.5	105.8	105.8	105.4	107.3
IQBS1	0 to 230 uA	55.0	55.0	64.0	63.7	62.9	63.1	63.9	63.6	62.1	62.8
D_IQDD1	0 to 3 uA	0.003	0.003	0	0.002	0.001	0.003	0	0.001	0.002	0
D_IQCC1	0 to 30 uA	0.125	0.563	0.313	0.125	0.188	0.313	0.375	0.063	0.313	0.063
D_IQBS1	0 to 20 uA	0.125	0.125	0.188	0.125	0.125	0.125	0.188	0	0.375	0.250





INTERNATIONAL RECTIFIER  
EL SEGUNDO, CALIFORNIA

# Appendix B3

## Post 150Krad, Dynamic Bias Electricals

**INTERNATIONAL RECTIFIER  
EL SEGUNDO, CALIFORNIA  
TEST SUMMARY**

CUSTOMER: NA  
 DEVICE : RIC7113L4  
 SPEC NO. : DOC:71-9837-17 REV:06 (c)SZ  
 JOB NO. : NA

L.D.C. : 800819  
 LOT NO: B7607  
 DATE : 25C  
 Location: POST 150K, DYNAMIC

<b>Total Units Tested: 12</b>	<b>Total units Passed: 12</b>	<b>Electrical Yield: %100.00</b>
-------------------------------	-------------------------------	----------------------------------

TESTS	Failed Qty	% Loss	Failed Serial Numbers
CONT_OPN			
DIOD_SHT			
V_MAX			
I_LEAK			
IQDD0			
IQCC0			
IQBS0			
IHIN0			
ILIN0			
ISD0			
IQDD1			
IQCC1			
IQBS1			
IHIN1			
ILIN1			
ISD1			
ILO+			
ILO-			
IHO+			
IHO-			
FN_15/15			
VOH_LS			
VOL_LS			
VOL_HS			
VOH_HS			
Vth+HS			
Vth-HS			
Vth+LS			
Vth-LS			
Vth+SD			
TON_LS			
TOFF_LS			
TR_LS			
TF_LS			
TON_HS			
TOFF_HS			
TR_HS			
TF_HS			
TSD_LS			
TSD_HS			
MT_ON			
MT_OFF			
VCCUV+pa			
VCCUV-pa			
VBSUV+pa			
VBSUV-pa			
IQDD1			
IQCC1			
IQBS1			
D_IQDD1			
D_IQCC1			
D_IQBS1			

**INTERNATIONAL RECTIFIER  
EL SEGUNDO, CALIFORNIA**

CUSTOMER: NA  
 DEVICE : RIC7113L4  
 SPEC NO. : DOC:71-9837-17 REV:06 (c)SZ  
 JOB NO. : NA

L.D.C. : 800819  
 LOT NO: B7607  
 DATE : 25C  
 Location: POST 150K, DYNAMIC

TESTS	LIMITS	8-2	15-6	20-8	25-8	30-10	33-10	40-14	41-14	53-17	63-20
CONT_OPN	0 to 0	0	0	0	0	0	0	0	0	0	0
DIOD_SHT	0 to 0	0	0	0	0	0	0	0	0	0	0
V_MAX	425 to 990 V	N/A	N/A	N/A	N/A	N/A	N/A	N/A	N/A	N/A	N/A
I_LEAK	-1 to 50 uA	2.2	1.7	1.8	1.5	1.6	1.6	1.7	1.6	2.0	1.6
IQDD0	0 to 30 uA	1.1	0.975	1.8	0.863	1.7	0.871	0.433	0.287	0.336	0.458
IQCC0	0 to 340 uA	86.9	92.0	86.6	87.1	89.3	87.8	91.7	91.3	92.8	87.4
IQBS0	0 to 230 uA	68.6	76.9	67.9	67.1	72.1	71.1	70.3	70.1	74.8	67.4
IHIN0	0 to 1 uA	0.016	0.013	0.013	0.013	0.013	0.012	0.013	0.013	0.013	0.012
ILIN0	0 to 1 uA	0.016	0.013	0.013	0.013	0.013	0.013	0.013	0.013	0.013	0.012
ISD0	0 to 1 uA	0.016	0.013	0.013	0.012	0.012	0.012	0.012	0.013	0.012	0.012
IQDD1	0 to 30 uA	0.959	0.757	1.4	0.696	1.5	0.649	0.386	0.258	0.664	0.415
IQCC1	0 to 340 uA	97.4	103.5	99.8	98.6	100.9	97.3	102.1	101.0	101.8	96.1
IQBS1	0 to 230 uA	51.1	58.2	50.4	50.5	55.0	54.3	53.3	53.5	58.1	52.4
IHIN1	0 to 40 uA	23.0	24.0	23.6	23.4	23.3	23.2	24.1	23.9	23.7	22.8
ILIN1	0 to 40 uA	23.1	24.2	23.6	23.6	23.5	23.3	24.4	24.2	23.8	22.8
ISD1	0 to 40 uA	22.9	23.9	23.4	23.4	23.2	23.1	24.0	23.8	23.5	22.6
ILO+	2 to 5 A	2.7	3.0	2.6	2.6	2.9	2.9	2.6	2.6	2.8	2.6
ILO-	2 to 5 A	3.1	3.2	3.0	3.0	3.1	3.1	2.9	2.9	3.0	2.9
IHO+	2 to 5 A	2.5	2.7	2.4	2.4	2.7	2.6	2.4	2.4	2.6	2.4
IHO-	2 to 5 A	3.3	3.4	3.1	3.1	3.3	3.3	3.0	3.1	3.2	3.1
FN_15/15	1 to 1	1	1	1	1	1	1	1	1	1	1
VOH_LS	0 to 1.2 V	0.077	0.077	0.082	0.082	0.076	0.085	0.111	0.119	0.113	0.123
VOL_LS	-0.01 to 0.1 V	0	0	0	0	0	0	0	0	0	0
VOL_HS	-0.01 to 0.1 V	0	0	0	0	0	0	0	0	0	0
VOH_HS	0 to 1.2 V	0.047	0.048	0.050	0.054	0.049	0.052	0.070	0.081	0.075	0.092
Vth+HS	6 to 9.5 V	7.8	7.9	7.9	7.9	7.9	7.9	8.0	8.0	8.0	8.1
Vth-HS	6 to 9.5 V	6.2	6.3	6.1	6.1	6.3	6.3	6.2	6.2	6.4	6.3
Vth+LS	6 to 9.5 V	7.8	7.9	7.9	7.9	7.9	7.9	8.0	8.0	8.0	8.0
Vth-LS	6 to 9.5 V	6.2	6.3	6.1	6.1	6.2	6.2	6.2	6.2	6.3	6.2
Vth+SD	6 to 9.5 V	8.2	8.2	8.2	8.2	8.2	8.2	8.3	8.3	8.3	8.3
TON_LS	50 to 200 ns	135.2	118.5	133.9	131.7	118.1	117.4	146.4	143.1	123.8	137.7
TOFF_LS	50 to 200 ns	125.7	112.1	121.1	117.7	108.1	107.9	130.6	128.8	114.2	120.6
TR_LS	2 to 35 ns	7.9	8.3	8.1	8.3	7.4	7.4	7.2	7.6	8.2	8.1
TF_LS	2 to 25 ns	5.6	5.7	6.6	6.1	6.5	6.5	6.3	6.8	6.3	6.3
TON_HS	50 to 150 ns	127.9	112.4	131.1	129.5	113.6	113.5	139.2	137.4	117.5	134.5
TOFF_HS	50 to 125 ns	114.3	101.5	115.4	113.2	100.7	101.1	122.8	121.6	105.5	118.0
TR_HS	2 to 35 ns	10.7	10.7	10.8	10.6	11.1	10.9	10.5	10.5	10.4	11.3
TF_HS	2 to 25 ns	10.0	10.2	9.5	8.8	10.2	10.0	11.0	10.4	10.9	8.6
TSD_LS	50 to 140 ns	125.5	111.7	119.7	116.3	107.4	106.9	130.9	128.6	113.1	120.0
TSD_HS	50 to 140 ns	117.3	104.4	118.0	116.6	103.2	103.7	126.9	124.2	108.2	121.3
MT_ON	0 to 20 ns	7.3	6.1	2.8	2.2	4.5	3.9	7.2	5.7	6.3	3.2
MT_OFF	0 to 20 ns	11.4	10.6	5.7	4.5	7.5	6.8	7.8	7.1	8.7	2.6
VCCUV+pa	7.4 to 9.6 V	8.5	8.5	8.5	8.4	8.4	8.5	8.4	8.4	8.5	8.4
VCCUV-pa	7 to 9.4 V	8.3	8.2	8.2	8.1	8.1	8.2	8.2	8.2	8.2	8.2
VBSUV+pa	7.5 to 9.7 V	8.6	8.6	8.5	8.6	8.5	8.6	8.6	8.6	8.6	8.5
VBSUV-pa	7 to 9.4 V	8.3	8.3	8.3	8.3	8.3	8.3	8.3	8.3	8.3	8.3
IQDD1	0 to 30 uA	0.921	0.732	1.4	0.684	1.5	0.632	0.373	0.251	0.431	0.398
IQCC1	0 to 340 uA	96.8	102.6	99.5	98.4	100.5	96.2	101.6	100.8	101.6	96.3
IQBS1	0 to 230 uA	50.6	57.8	50.3	49.9	54.4	53.6	52.9	53.2	58.2	51.9
D_IQDD1	0 to 3 uA	0.038	0.025	0.035	0.012	0.013	0.017	0.013	0.007	0.233	0.017
D_IQCC1	0 to 30 uA	0.688	0.875	0.250	0.125	0.438	1.1	0.500	0.250	0.188	0.250
D_IQBS1	0 to 20 uA	0.500	0.438	0.188	0.563	0.625	0.625	0.438	0.313	0.063	0.438



INTERNATIONAL RECTIFIER  
EL SEGUNDO, CALIFORNIA

## Appendix B4

### Post 150Krad, Static Bias Electricals

**INTERNATIONAL RECTIFIER  
EL SEGUNDO, CALIFORNIA  
TEST SUMMARY**

CUSTOMER: NA  
 DEVICE : RIC7113L4  
 SPEC NO. : DOC:71-9837-17 REV:06 (c)SZ  
 JOB NO. : NA

L.D.C. : 800819  
 LOT NO: B7607  
 DATE : 25C  
 Location: POST 150K, STATIC

<b>Total Units Tested: 32</b>	<b>Total units Passed: 32</b>	<b>Electrical Yield: %100.00</b>
-------------------------------	-------------------------------	----------------------------------

TESTS	Failed Qty	% Loss	Failed Serial Numbers
CONT_OPN			
DIOD_SHT			
V_MAX			
I_LEAK			
IQDD0			
IQCC0			
IQBS0			
IHIN0			
ILIN0			
ISD0			
IQDD1			
IQCC1			
IQBS1			
IHIN1			
ILIN1			
ISD1			
ILO+			
ILO-			
IHO+			
IHO-			
FN_15/15			
VOH_LS			
VOL_LS			
VOL_HS			
VOH_HS			
Vth+HS			
Vth-HS			
Vth+LS			
Vth-LS			
Vth+SD			
TON_LS			
TOFF_LS			
TR_LS			
TF_LS			
TON_HS			
TOFF_HS			
TR_HS			
TF_HS			
TSD_LS			
TSD_HS			
MT_ON			
MT_OFF			
VCCUV+pa			
VCCUV-pa			
VBSUV+pa			
VBSUV-pa			
IQDD1			
IQCC1			
IQBS1			
D_IQDD1			
D_IQCC1			
D_IQBS1			

**INTERNATIONAL RECTIFIER  
EL SEGUNDO, CALIFORNIA**

CUSTOMER: NA  
 DEVICE : RIC7113L4  
 SPEC NO. : DOC:71-9837-17 REV:06 (c)SZ  
 JOB NO. : NA

L.D.C. : 800819  
 LOT NO: B7607  
 DATE : 25C  
 Location: POST 150K, STATIC

TESTS	LIMITS	3-2	4-2	5-2	6-2	12-6	16-6	17-6	18-6	21-8	22-8
CONT_OPN	0 to 0	0	0	0	0	0	0	0	0	0	0
DIOD_SHT	0 to 0	0	0	0	0	0	0	0	0	0	0
V_MAX	425 to 990 V	N/A	N/A	N/A	N/A	N/A	N/A	N/A	N/A	N/A	N/A
I_LEAK	-1 to 50 uA	1.7	1.5	1.3	1.8	1.6	1.8	1.8	1.7	1.9	1.7
IQDD0	0 to 30 uA	0.041	0.044	0.042	0.044	0.043	0.043	0.044	0.044	0.041	0.042
IQCC0	0 to 340 uA	85.9	86.3	109.5	86.6	90.2	91.1	90.9	90.9	86.2	85.0
IQBS0	0 to 230 uA	67.0	67.0	66.1	67.9	76.9	78.3	76.7	77.7	66.6	65.6
IHIN0	0 to 1 uA	0.013	0.013	0.013	0.013	0.013	0.013	0.013	0.013	0.013	0.013
ILIN0	0 to 1 uA	0.013	0.013	0.013	0.013	0.013	0.013	0.013	0.013	0.013	0.013
ISD0	0 to 1 uA	0.012	0.012	0.013	0.012	0.013	0.013	0.013	0.013	0.012	0.012
IQDD1	0 to 30 uA	0.054	0.057	0.054	0.056	0.056	0.058	0.056	0.059	0.054	0.056
IQCC1	0 to 340 uA	93.0	93.3	120.3	93.5	97.1	98.4	98.3	97.7	93.6	92.1
IQBS1	0 to 230 uA	50.4	50.9	49.3	51.4	59.1	60.1	59.0	59.6	49.8	49.3
IHIN1	0 to 40 uA	23.6	23.4	24.0	23.3	24.3	24.4	24.4	24.2	23.9	23.3
ILIN1	0 to 40 uA	23.9	23.8	24.2	23.7	24.6	24.7	24.8	24.6	24.2	23.6
ISD1	0 to 40 uA	23.6	23.5	23.9	23.4	24.3	24.4	24.4	24.1	23.9	23.4
ILO+	2 to 5 A	2.7	2.7	2.7	2.8	3.1	3.1	3.1	3.1	2.7	2.6
ILO-	2 to 5 A	3.1	3.1	3.0	3.1	3.3	3.3	3.3	3.3	3.0	3.0
IHO+	2 to 5 A	2.5	2.5	2.5	2.6	2.8	2.8	2.8	2.8	2.4	2.4
IHO-	2 to 5 A	3.3	3.3	3.2	3.3	3.5	3.5	3.5	3.5	3.2	3.2
FN_15/15	1 to 1	1	1	1	1	1	1	1	1	1	1
VOH_LS	0 to 1.2 V	0.082	0.086	0.087	0.076	0.082	0.077	0.077	0.072	0.090	0.090
VOL_LS	-0.01 to 0.1 V	0	0	0	0	0	0	0	0	0	0
VOL_HS	-0.01 to 0.1 V	0	0	0	0	0	0	0	0	0	0
VOH_HS	0 to 1.2 V	0.059	0.063	0.063	0.055	0.057	0.055	0.055	0.050	0.072	0.068
Vth+HS	6 to 9.5 V	8.0	8.0	8.0	8.0	8.1	8.1	8.2	8.1	8.0	8.0
Vth-HS	6 to 9.5 V	6.5	6.5	6.5	6.5	6.7	6.8	6.8	6.7	6.5	6.5
Vth+LS	6 to 9.5 V	8.0	8.0	8.0	8.0	8.1	8.1	8.1	8.1	8.0	8.0
Vth-LS	6 to 9.5 V	6.5	6.5	6.4	6.5	6.7	6.7	6.7	6.7	6.4	6.5
Vth+SD	6 to 9.5 V	8.0	8.0	8.0	8.0	8.1	8.1	8.1	8.1	8.0	8.0
TON_LS	50 to 200 ns	135.8	136.3	146.0	133.1	112.4	110.5	113.0	111.2	134.4	133.9
TOFF_LS	50 to 200 ns	127.2	127.7	133.7	124.8	108.1	107.6	109.0	107.8	121.6	121.2
TR_LS	2 to 35 ns	7.8	7.6	7.8	7.9	8.2	8.1	7.8	8.2	8.5	8.0
TF_LS	2 to 25 ns	6.2	6.5	5.8	6.2	6.8	7.6	5.9	7.1	6.6	6.4
TON_HS	50 to 200 ns	129.1	129.7	138.4	126.9	106.1	104.4	107.0	104.9	132.5	130.1
TOFF_HS	50 to 200 ns	114.6	115.7	121.8	112.8	97.4	96.5	97.9	96.6	115.4	113.7
TR_HS	2 to 35 ns	10.4	10.6	10.5	10.6	10.8	11.0	10.7	10.9	10.6	10.9
TF_HS	2 to 25 ns	9.0	9.0	9.7	9.3	8.6	8.6	8.9	8.9	9.7	10.9
TSD_LS	50 to 140 ns	127.6	128.5	134.7	125.9	108.5	108.1	109.4	107.9	120.7	120.8
TSD_HS	50 to 140 ns	117.5	118.2	125.1	116.2	99.1	97.9	100.2	98.4	118.6	116.4
MT_ON	0 to 20 ns	6.7	6.6	7.6	6.2	6.3	6.1	6.0	6.3	2.0	3.8
MT_OFF	0 to 20 ns	12.6	12.1	11.9	12.0	10.7	11.1	11.1	11.2	6.2	7.5
VCCUV+pa	7.4 to 9.6 V	8.6	8.6	8.6	8.6	8.6	8.6	8.6	8.6	8.6	8.6
VCCUV-pa	7 to 9.4 V	8.3	8.4	8.4	8.3	8.4	8.3	8.3	8.3	8.3	8.3
VBSUV+pa	7.5 to 9.7 V	8.4	8.4	8.6	8.6	8.6	8.6	8.6	8.6	8.6	8.5
VBSUV-pa	7 to 9.4 V	8.2	8.2	8.3	8.3	8.3	8.3	8.3	8.3	8.3	8.3
IQDD1	0 to 30 uA	0.055	0.055	0.055	0.054	0.056	0.058	0.054	0.056	0.053	0.055
IQCC1	0 to 340 uA	92.9	93.2	119.9	92.8	96.4	97.8	97.6	97.4	93.4	91.9
IQBS1	0 to 230 uA	50.7	50.4	49.1	51.3	58.6	59.8	58.2	59.1	49.5	48.7
D_IQDD1	0 to 3 uA	0	0.002	0.001	0.001	0	0	0.002	0.003	0.001	0.001
D_IQCC1	0 to 30 uA	0.125	0.063	0.375	0.750	0.625	0.688	0.688	0.313	0.188	0.125
D_IQBS1	0 to 20 uA	0.250	0.563	0.250	0.188	0.438	0.313	0.813	0.438	0.313	0.625



**INTERNATIONAL RECTIFIER  
EL SEGUNDO, CALIFORNIA**

CUSTOMER: NA  
 DEVICE : RIC7113L4  
 SPEC NO. : DOC:71-9837-17 REV:06 (c)SZ  
 JOB NO. : NA

L.D.C. : 800819  
 LOT NO: B7607  
 DATE : 25C  
 Location: POST 150K, STATIC

TESTS	LIMITS	26-8	27-8	34-10	35-10	36-10	37-10	44-14	45-14	46-14	47-14
CONT_OPN	0 to 0	0	0	0	0	0	0	0	0	0	0
DIOD_SHT	0 to 0	0	0	0	0	0	0	0	0	0	0
V_MAX	425 to 990 V	N/A	N/A	N/A	N/A	N/A	N/A	N/A	N/A	N/A	N/A
I_LEAK	-1 to 50 uA	1.9	1.4	2.1	1.8	1.7	1.7	2.2	1.7	1.7	1.8
IQDD0	0 to 30 uA	0.045	0.041	0.043	0.044	0.048	0.040	0.038	0.043	0.039	0.039
IQCC0	0 to 340 uA	86.3	85.1	87.8	86.9	90.1	88.1	92.1	90.8	90.1	92.6
IQBS0	0 to 230 uA	66.4	65.6	70.9	70.8	73.3	71.4	69.5	70.0	68.7	70.8
IHIN0	0 to 1 uA	0.013	0.013	0.013	0.013	0.013	0.013	0.013	0.013	0.013	0.013
ILIN0	0 to 1 uA	0.013	0.013	0.013	0.013	0.013	0.013	0.013	0.013	0.013	0.014
ISD0	0 to 1 uA	0.012	0.012	0.013	0.012	0.013	0.013	0.013	0.013	0.013	0.013
IQDD1	0 to 30 uA	0.055	0.054	0.054	0.053	0.058	0.056	0.051	0.052	0.051	0.051
IQCC1	0 to 340 uA	94.0	92.0	94.9	93.8	96.9	95.0	100.1	98.7	97.6	100.8
IQBS1	0 to 230 uA	49.5	49.1	54.1	54.1	55.4	54.9	52.3	53.5	52.3	53.4
IHIN1	0 to 40 uA	23.9	23.3	23.8	23.6	24.7	23.9	24.5	24.3	23.8	24.8
ILIN1	0 to 40 uA	24.2	23.6	24.2	23.8	24.9	24.3	24.9	24.5	24.2	25.1
ISD1	0 to 40 uA	23.9	23.3	23.9	23.6	24.7	24.0	24.6	24.2	23.9	24.8
ILO+	2 to 5 A	2.7	2.6	2.9	2.9	2.8	2.9	2.5	2.6	2.5	2.5
ILO-	2 to 5 A	3.0	3.0	3.2	3.1	3.1	3.1	2.8	2.9	2.8	2.8
IHO+	2 to 5 A	2.5	2.4	2.6	2.6	2.6	2.6	2.3	2.4	2.3	2.3
IHO-	2 to 5 A	3.2	3.2	3.3	3.3	3.3	3.3	3.0	3.0	3.0	3.0
FN_15/15	1 to 1	1	1	1	1	1	1	1	1	1	1
VOH_LS	0 to 1.2 V	0.085	0.085	0.088	0.086	0.077	0.079	0.141	0.133	0.129	0.131
VOL_LS	-0.01 to 0.1 V	0	0	0	0	0	0	0	0	0	0
VOL_HS	-0.01 to 0.1 V	0	0	0	0	0	0	0	0	0	0
VOH_HS	0 to 1.2 V	0.068	0.062	0.066	0.062	0.053	0.060	0.116	0.109	0.107	0.108
Vth+HS	6 to 9.5 V	8.0	8.0	8.1	8.1	8.1	8.1	8.2	8.2	8.2	8.2
Vth-HS	6 to 9.5 V	6.5	6.5	6.6	6.6	6.6	6.6	6.5	6.6	6.6	6.6
Vth+LS	6 to 9.5 V	8.0	8.0	8.1	8.1	8.1	8.1	8.2	8.2	8.2	8.2
Vth-LS	6 to 9.5 V	6.4	6.4	6.6	6.6	6.6	6.6	6.5	6.5	6.5	6.5
Vth+SD	6 to 9.5 V	8.0	8.0	8.1	8.1	8.1	8.1	8.2	8.2	8.2	8.2
TON_LS	50 to 200 ns	134.8	135.2	118.8	118.1	119.9	118.0	150.1	145.7	148.7	147.9
TOFF_LS	50 to 200 ns	121.9	122.4	109.0	110.5	112.3	109.5	136.1	132.7	135.6	133.4
TR_LS	2 to 35 ns	8.6	7.9	8.0	7.9	7.4	8.4	7.6	7.2	7.3	7.4
TF_LS	2 to 25 ns	7.1	6.5	6.4	6.2	6.1	6.3	6.6	6.3	6.1	6.5
TON_HS	50 to 200 ns	133.0	131.4	115.7	115.2	117.1	114.5	144.8	140.2	143.4	142.3
TOFF_HS	50 to 200 ns	115.8	114.8	101.3	101.6	102.9	101.0	127.1	123.9	127.1	125.0
TR_HS	2 to 35 ns	10.4	11.1	11.0	10.7	10.9	10.7	10.9	11.0	11.1	11.0
TF_HS	2 to 25 ns	9.3	10.6	10.2	10.9	10.8	10.5	10.3	11.1	10.7	10.8
TSD_LS	50 to 140 ns	121.6	122.5	108.7	109.2	110.9	108.7	136.5	132.8	135.5	133.4
TSD_HS	50 to 140 ns	119.5	118.2	104.2	104.1	105.7	103.6	131.2	127.5	130.3	129.2
MT_ON	0 to 20 ns	1.8	3.9	3.1	2.8	2.7	3.5	5.3	5.5	5.3	5.6
MT_OFF	0 to 20 ns	6.1	7.6	7.7	8.9	9.3	8.5	8.9	8.9	8.5	8.4
VCCUV+pa	7.4 to 9.6 V	8.6	8.6	8.6	8.6	8.6	8.6	8.6	8.6	8.6	8.5
VCCUV-pa	7 to 9.4 V	8.3	8.3	8.3	8.3	8.3	8.3	8.3	8.3	8.3	8.3
VBSUV+pa	7.5 to 9.7 V	8.5	8.5	8.5	8.6	8.5	8.5	8.6	8.6	8.6	8.6
VBSUV-pa	7 to 9.4 V	8.2	8.3	8.2	8.3	8.2	8.3	8.3	8.3	8.3	8.3
IQDD1	0 to 30 uA	0.052	0.053	0.054	0.053	0.054	0.056	0.050	0.051	0.051	0.050
IQCC1	0 to 340 uA	93.6	91.6	94.9	93.9	96.1	94.4	99.9	98.9	97.4	100.9
IQBS1	0 to 230 uA	49.1	48.6	54.3	54.0	55.1	54.1	52.3	53.1	52.1	53.2
D_IQDD1	0 to 3 uA	0.003	0.002	0	0	0.004	0	0.001	0	0	0
D_IQCC1	0 to 30 uA	0.438	0.375	0.063	0.188	0.875	0.563	0.125	0.250	0.250	0.063
D_IQBS1	0 to 20 uA	0.375	0.500	0.250	0.063	0.313	0.813	0	0.375	0.188	0.188

**INTERNATIONAL RECTIFIER  
EL SEGUNDO, CALIFORNIA**

CUSTOMER: NA  
 DEVICE : RIC7113L4  
 SPEC NO. : DOC:71-9837-17 REV:06 (c)SZ  
 JOB NO. : NA

L.D.C. : 800819  
 LOT NO: B7607  
 DATE : 25C  
 Location: POST 150K, STATIC

TESTS	LIMITS	50-17	51-17	52-17	54-17	58-20	59-20	60-20	61-20	68-23	69-23
CONT_OPN	0 to 0	0	0	0	0	0	0	0	0	0	0
DIOD_SHT	0 to 0	0	0	0	0	0	0	0	0	0	0
V_MAX	425 to 990 V	N/A	N/A	N/A	N/A	N/A	N/A	N/A	N/A	N/A	N/A
I_LEAK	-1 to 50 uA	1.8	1.1	1.9	1.7	1.6	1.9	1.6	1.5	1.7	1.6
IQDD0	0 to 30 uA	0.040	0.040	0.038	0.042	0.040	0.039	0.038	0.040	0.040	0.040
IQCC0	0 to 340 uA	89.5	94.6	94.6	90.3	86.9	86.9	87.9	87.4	93.1	93.1
IQBS0	0 to 230 uA	74.9	74.5	75.0	74.6	67.0	67.8	66.4	66.6	78.1	77.5
IHIN0	0 to 1 uA	0.013	0.013	0.013	0.013	0.012	0.012	0.013	0.013	0.013	0.013
ILIN0	0 to 1 uA	0.012	0.013	0.013	0.013	0.013	0.013	0.013	0.013	0.013	0.013
ISD0	0 to 1 uA	0.012	0.013	0.013	0.012	0.012	0.012	0.012	0.012	0.013	0.013
IQDD1	0 to 30 uA	0.055	0.055	0.050	0.053	0.051	0.051	0.050	0.053	0.051	0.052
IQCC1	0 to 340 uA	96.0	99.4	100.3	98.1	94.1	94.1	95.1	94.5	100.6	100.8
IQBS1	0 to 230 uA	58.7	58.4	58.6	58.4	51.7	52.2	51.6	51.5	61.3	60.9
IHIN1	0 to 40 uA	23.5	24.0	24.0	23.7	23.1	23.0	23.1	23.0	24.4	24.4
ILIN1	0 to 40 uA	23.4	24.2	24.1	24.0	23.3	23.3	23.3	23.2	24.6	24.6
ISD1	0 to 40 uA	23.3	24.0	24.0	23.7	23.1	22.9	23.1	23.0	24.5	24.4
ILO+	2 to 5 A	2.9	2.8	2.8	2.9	2.6	2.6	2.6	2.7	2.9	2.9
ILO-	2 to 5 A	3.1	3.0	3.1	3.1	2.9	3.0	2.9	2.9	3.1	3.1
IHO+	2 to 5 A	2.6	2.6	2.6	2.6	2.4	2.4	2.4	2.4	2.6	2.7
IHO-	2 to 5 A	3.2	3.2	3.2	3.2	3.1	3.1	3.1	3.1	3.2	3.2
FN_15/15	1 to 1	1	1	1	1	1	1	1	1	1	1
VOH_LS	0 to 1.2 V	0.115	0.124	0.115	0.104	0.139	0.137	0.134	0.128	0.115	0.108
VOL_LS	-0.01 to 0.1 V	0	0	0	0	0	0	0	0	0	0
VOL_HS	-0.01 to 0.1 V	0	0	0	0	0	0	0	0	0	0
VOH_HS	0 to 1.2 V	0.093	0.102	0.090	0.082	0.113	0.113	0.107	0.104	0.092	0.085
Vth+HS	6 to 9.5 V	8.3	8.2	8.2	8.2	8.2	8.2	8.2	8.2	8.2	8.2
Vth-HS	6 to 9.5 V	6.8	6.7	6.7	6.7	6.6	6.6	6.6	6.6	6.7	6.7
Vth+LS	6 to 9.5 V	8.2	8.2	8.2	8.2	8.2	8.2	8.2	8.2	8.2	8.2
Vth-LS	6 to 9.5 V	6.7	6.7	6.6	6.7	6.5	6.5	6.5	6.5	6.7	6.7
Vth+SD	6 to 9.5 V	8.2	8.2	8.2	8.2	8.2	8.2	8.2	8.2	8.2	8.2
TON_LS	50 to 200 ns	119.4	125.5	124.6	121.9	138.7	138.0	138.3	138.2	117.8	116.4
TOFF_LS	50 to 200 ns	111.6	116.9	116.9	114.6	123.4	122.9	123.2	122.6	106.7	106.4
TR_LS	2 to 35 ns	7.6	7.7	7.7	8.0	8.2	8.3	7.5	8.4	7.6	7.7
TF_LS	2 to 25 ns	6.1	5.8	5.6	5.6	6.3	6.4	6.5	6.4	6.7	6.5
TON_HS	50 to 200 ns	114.7	119.6	119.0	115.9	136.0	135.5	135.1	135.5	113.2	112.4
TOFF_HS	50 to 200 ns	103.8	106.8	106.5	104.8	118.6	118.0	118.1	117.8	100.8	100.6
TR_HS	2 to 35 ns	11.1	10.9	10.9	10.6	10.7	10.4	10.9	10.7	11.0	11.1
TF_HS	2 to 25 ns	10.4	10.3	10.4	10.7	9.1	9.0	9.0	9.1	9.0	8.8
TSD_LS	50 to 140 ns	110.9	116.8	116.8	114.2	123.5	122.1	122.6	123.2	106.3	105.6
TSD_HS	50 to 140 ns	106.9	109.9	109.0	107.0	122.1	122.3	121.9	122.1	104.1	103.4
MT_ON	0 to 20 ns	4.7	5.9	5.5	6.1	2.7	2.5	3.2	2.7	4.7	4.0
MT_OFF	0 to 20 ns	7.8	10.1	10.4	9.8	4.9	4.9	5.1	4.8	5.9	5.9
VCCUV+pa	7.4 to 9.6 V	8.6	8.6	8.6	8.6	8.6	8.5	8.6	8.5	8.6	8.6
VCCUV-pa	7 to 9.4 V	8.3	8.3	8.3	8.4	8.3	8.3	8.3	8.2	8.3	8.4
VBSUV+pa	7.5 to 9.7 V	8.6	8.6	8.6	8.6	8.5	8.5	8.6	8.5	8.6	8.6
VBSUV-pa	7 to 9.4 V	8.3	8.3	8.3	8.3	8.2	8.3	8.3	8.2	8.3	8.3
IQDD1	0 to 30 uA	0.050	0.052	0.051	0.051	0.051	0.048	0.049	0.050	0.050	0.049
IQCC1	0 to 340 uA	96.3	99.4	100.1	98.3	94.0	94.3	94.9	94.5	100.6	100.3
IQBS1	0 to 230 uA	58.8	57.8	58.4	58.4	51.6	52.6	51.2	51.4	60.9	60.7
D_IQDD1	0 to 3 uA	0.005	0.003	0	0.001	0	0.004	0	0.003	0	0.003
D_IQCC1	0 to 30 uA	0.250	0.063	0.125	0.188	0.125	0.188	0.188	0	0	0.500
D_IQBS1	0 to 20 uA	0.063	0.688	0.250	0.063	0.125	0.375	0.375	0.125	0.375	0.250

**INTERNATIONAL RECTIFIER  
EL SEGUNDO, CALIFORNIA**

CUSTOMER: NA  
 DEVICE : RIC7113L4  
 SPEC NO. : DOC:71-9837-17 REV:06 (c)SZ  
 JOB NO. : NA

L.D.C. : 800819  
 LOT NO: B7607  
 DATE : 25C  
 Location: POST 150K, STATIC

TESTS	LIMITS	70-23	73-23						
CONT_OPN	0 to 0	0	0						
DIOD_SHT	0 to 0	0	0						
V_MAX	425 to 990 V	N/A	N/A						
I_LEAK	-1 to 50 uA	1.9	1.9						
IQDD0	0 to 30 uA	0.039	0.040						
IQCC0	0 to 340 uA	92.3	93.3						
IQBS0	0 to 230 uA	76.1	76.0						
IHIN0	0 to 1 uA	0.013	0.013						
ILIN0	0 to 1 uA	0.013	0.013						
ISD0	0 to 1 uA	0.013	0.013						
IQDD1	0 to 30 uA	0.051	0.054						
IQCC1	0 to 340 uA	100.3	101.2						
IQBS1	0 to 230 uA	59.6	59.1						
IHIN1	0 to 40 uA	24.2	24.3						
ILIN1	0 to 40 uA	24.5	24.6						
ISD1	0 to 40 uA	24.2	24.4						
ILO+	2 to 5 A	2.9	2.9						
ILO-	2 to 5 A	3.1	3.1						
IHO+	2 to 5 A	2.7	2.6						
IHO-	2 to 5 A	3.2	3.2						
FN_15/15	1 to 1	1	1						
VOH_LS	0 to 1.2 V	0.111	0.105						
VOL_LS	-0.01 to 0.1 V	0	0						
VOL_HS	-0.01 to 0.1 V	0	0						
VOH_HS	0 to 1.2 V	0.085	0.083						
Vth+HS	6 to 9.5 V	8.2	8.2						
Vth-HS	6 to 9.5 V	6.7	6.7						
Vth+LS	6 to 9.5 V	8.2	8.2						
Vth-LS	6 to 9.5 V	6.7	6.7						
Vth+SD	6 to 9.5 V	8.2	8.2						
TON_LS	50 to 200 ns	117.9	116.6						
TOFF_LS	50 to 200 ns	107.5	106.7						
TR_LS	2 to 35 ns	7.4	8.0						
TF_LS	2 to 25 ns	6.9	6.4						
TON_HS	50 to 200 ns	112.8	113.1						
TOFF_HS	50 to 200 ns	100.8	100.7						
TR_HS	2 to 35 ns	11.3	11.1						
TF_HS	2 to 25 ns	9.5	8.8						
TSD_LS	50 to 140 ns	106.7	105.7						
TSD_HS	50 to 140 ns	103.6	102.8						
MT_ON	0 to 20 ns	5.1	3.5						
MT_OFF	0 to 20 ns	6.7	6.0						
VCCUV+pa	7.4 to 9.6 V	8.6	8.6						
VCCUV-pa	7 to 9.4 V	8.4	8.3						
VBSUV+pa	7.5 to 9.7 V	8.6	8.6						
VBSUV-pa	7 to 9.4 V	8.4	8.3						
IQDD1	0 to 30 uA	0.052	0.050						
IQCC1	0 to 340 uA	100.3	101.1						
IQBS1	0 to 230 uA	59.4	59.0						
D_IQDD1	0 to 3 uA	0	0.004						
D_IQCC1	0 to 30 uA	0.063	0.125						
D_IQBS1	0 to 20 uA	0.125	0.063						

INTERNATIONAL RECTIFIER  
EL SEGUNDO, CALIFORNIA

# Appendix B5

## Post Accelerated Aging, Dynamic Bias Electricals

**INTERNATIONAL RECTIFIER  
EL SEGUNDO, CALIFORNIA  
TEST SUMMARY**

CUSTOMER: IR  
 DEVICE : RIC7113L4  
 SPEC NO. : DOC:71-9837-17 REV:06 (c)SZ  
 JOB NO. : N/A

L.D.C. : 0007  
 LOT NO: B7607A  
 DATE : 3-17-00  
 Location: Dynamic Bias, E3, Post 168 hr.  
 Ageing

<b>Total Units Tested: 12</b>	<b>Total units Passed: 12</b>	<b>Electrical Yield: %100.00</b>
-------------------------------	-------------------------------	----------------------------------

TESTS	Failed Qty	% Loss	Failed Serial Numbers
CONT_OPN			
DIOD_SHT			
V_MAX			
I_LEAK			
IQDD0			
IQCC0			
IQBS0			
IHIN0			
ILIN0			
ISD0			
IQDD1			
IQCC1			
IQBS1			
IHIN1			
ILIN1			
ISD1			
ILO+			
ILO-			
IHO+			
IHO-			
FN_15/15			
VOH_LS			
VOL_LS			
VOL_HS			
VOH_HS			
Vth+HS			
Vth-HS			
Vth+LS			
Vth-LS			
Vth+SD			
TON_LS			
TOFF_LS			
TR_LS			
TF_LS			
TON_HS			
TOFF_HS			
TR_HS			
TF_HS			
TSD_LS			
TSD_HS			
MT_ON			
MT_OFF			
VCCUV+pa			
VCCUV-pa			
VBSUV+pa			
VBSUV-pa			
IQDD1			
IQCC1			
IQBS1			
D_IQDD1			
D_IQCC1			
D_IQBS1			

**INTERNATIONAL RECTIFIER  
EL SEGUNDO, CALIFORNIA**

CUSTOMER: IR  
 DEVICE : RIC7113L4  
 SPEC NO. : DOC:71-9837-17 REV:06 (c)SZ  
 JOB NO. : N/A

L.D.C. : 0007  
 LOT NO: B7607A  
 DATE : 3-17-00  
 Location: Dynamic Bias, E3, Post 168 hr. Ageing

TESTS	LIMITS	8	15	20	25	30	33	40	41	53	63
CONT_OPN	0 to 0	0	0	0	0	0	0	0	0	0	0
DIOD_SHT	0 to 0	0	0	0	0	0	0	0	0	0	0
V_MAX	425 to 990 V	N/A	N/A	N/A	N/A	N/A	N/A	N/A	N/A	N/A	N/A
I_LEAK	-1 to 50 uA	1.7	1.6	1.3	1.5	1.7	1.8	0.933	1.8	1.8	1.5
IQDD0	0 to 100 uA	0.040	0.038	0.038	0.037	0.036	0.039	0.036	0.039	0.038	0.037
IQCC0	0 to 1000 uA	81.6	84.4	81.6	81.8	83.2	82.0	89.3	89.4	90.8	85.8
IQBS0	0 to 1000 uA	64.7	71.0	64.3	64.4	67.6	67.0	69.1	68.7	72.9	66.5
IHIN0	0 to 1 uA	0.013	0.013	0.013	0.013	0.013	0.013	0.013	0.013	0.013	0.013
ILIN0	0 to 1 uA	0.013	0.013	0.013	0.013	0.013	0.013	0.014	0.013	0.013	0.013
ISD0	0 to 1 uA	0.013	0.013	0.013	0.013	0.013	0.012	0.013	0.013	0.013	0.012
IQDD1	0 to 100 uA	0.048	0.050	0.049	0.051	0.049	0.048	0.049	0.053	1.1	0.049
IQCC1	0 to 1000 uA	89.9	92.4	89.6	89.9	91.3	90.1	97.7	97.8	98.6	93.3
IQBS1	0 to 1000 uA	48.5	54.0	47.6	47.3	51.4	51.0	51.8	52.0	56.6	51.0
IHIN1	0 to 70 uA	24.2	24.7	24.3	24.1	24.0	23.9	24.7	24.6	24.4	23.4
ILIN1	0 to 70 uA	24.3	24.9	24.3	24.4	24.3	24.0	25.0	24.9	24.6	23.5
ISD1	0 to 70 uA	24.2	24.6	24.1	24.1	24.0	23.8	24.6	24.6	24.3	23.3
ILO+	2 to 5 A	2.6	2.9	2.5	2.5	2.8	2.8	2.5	2.5	2.7	2.5
ILO-	2 to 5 A	2.9	3.2	2.8	2.8	3.1	3.1	2.7	2.8	3.0	2.8
IHO+	2 to 5 A	2.4	2.7	2.3	2.3	2.6	2.5	2.3	2.3	2.5	2.3
IHO-	2 to 5 A	3.2	3.4	3.0	3.0	3.3	3.3	3.0	3.0	3.2	3.0
FN_15/15	1 to 1	1	1	1	1	1	1	1	1	1	1
VOH_LS	0 to 1.2 V	0.261	0.251	0.295	0.299	0.265	0.276	0.370	0.367	0.341	0.367
VOL_LS	-0.01 to 0.1 V	0	0	0	0	0	0	0	0	0	0
VOL_HS	-0.01 to 0.1 V	0	0	0	0	0	0	0	0	0	0
VOH_HS	0 to 1.2 V	0.237	0.229	0.271	0.275	0.242	0.251	0.340	0.341	0.315	0.343
Vth+HS	6 to 9.5 V	7.8	7.9	7.9	7.8	7.9	7.9	8.0	8.0	8.0	8.0
Vth-HS	6 to 9.5 V	6.1	6.3	6.1	6.1	6.2	6.2	6.2	6.2	6.3	6.2
Vth+LS	6 to 9.5 V	7.8	7.9	7.8	7.8	7.9	7.8	8.0	8.0	7.9	8.0
Vth-LS	6 to 9.5 V	6.1	6.2	6.1	6.1	6.2	6.2	6.1	6.2	6.3	6.2
Vth+SD	6 to 9.5 V	8.2	8.3	8.3	8.2	8.3	8.3	8.4	8.4	8.4	8.4
TON_LS	50 to 200 ns	139.9	121.2	136.8	133.6	119.8	119.3	149.4	146.4	126.5	139.9
TOFF_LS	50 to 200 ns	134	117.3	127.2	123.5	113.8	113.4	137.3	135.4	119.6	127
TR_LS	2 to 35 ns	7.7	7.4	8.2	7.9	8.0	8.3	7.8	7.3	7.3	8.4
TF_LS	2 to 25 ns	5.8	6.0	6.7	6.7	6.9	7.1	7.2	7.4	6.1	7.2
TON_HS	50 to 150 ns	134.1	115.6	136.0	134.2	117.8	117.4	144.0	142.1	121.2	139.1
TOFF_HS	50 to 200 ns	123.8	107.8	122.7	120.5	107.4	107.6	131.7	130	111.9	126.2
TR_HS	2 to 35 ns	10.9	11.4	10.1	9.7	10.5	10.3	11.1	10.9	10.9	9.9
TF_HS	2 to 25 ns	10.2	10.1	9.2	8.9	9.6	9.0	11.2	10.8	10.6	8.7
TSD_LS	50 to 140 ns	132.7	115.7	125.6	122.1	111.6	111.2	135.9	134.4	117.9	126.0
TSD_HS	50 to 140 ns	125.2	109.5	125.5	123.7	108.9	109.5	134.6	132.2	114.2	129.1
MT_ON	0 to 20 ns	5.9	5.6	0.790	0.640	2.1	1.9	5.5	4.3	5.3	0.810
MT_OFF	0 to 20 ns	10.2	9.5	4.5	3.0	6.4	5.7	5.6	5.4	7.8	0.830
VCCUV+pa	7.4 to 9.6 V	9.3	9.2	9.2	9.2	9.1	9.3	9.2	9.2	9.3	9.2
VCCUV-pa	7 to 9.4 V	9.0	8.9	8.9	8.9	8.8	9.0	9.0	8.9	9.0	8.9
VBSUV+pa	7.5 to 9.7 V	8.3	8.3	8.3	8.3	8.3	8.3	8.3	8.3	8.3	8.3
VBSUV-pa	7 to 9.4 V	8.1	8.1	8.0	8.0	8.0	8.0	8.0	8.1	8.1	8.0
IQDD1	0 to 30 uA	0.051	0.050	0.051	0.048	0.046	0.049	0.048	0.048	1.0	0.047
IQCC1	0 to 340 uA	90.0	92.5	89.6	89.8	91.2	90.0	97.9	97.8	98.5	93.2
IQBS1	0 to 230 uA	48.6	54.2	47.5	47.3	51.7	51.0	51.8	51.9	56.6	50.9
D_IQDD1	0 to 3 uA	0.003	0	0.001	0.003	0.003	0.001	0.001	0.006	0.064	0.003
D_IQCC1	0 to 30 uA	0.125	0.063	0.063	0.125	0.063	0.125	0.188	0	0.063	0.125
D_IQBS1	0 to 20 uA	0.063	0.188	0.063	0	0.250	0	0.063	0.063	0.063	0.063

**INTERNATIONAL RECTIFIER  
EL SEGUNDO, CALIFORNIA**

CUSTOMER: IR  
 DEVICE : RIC7113L4  
 SPEC NO. : DOC:71-9837-17 REV:06 (c)SZ  
 JOB NO. : N/A

L.D.C. : 0007  
 LOT NO: B7607A  
 DATE : 3-17-00  
 Location: Dynamic Bias, E3, Post 168 hr. Ageing

TESTS	LIMITS	65	66						
CONT_OPN	0 to 0	0	0						
DIOD_SHT	0 to 0	0	0						
V_MAX	425 to 990 V	N/A	N/A						
I_LEAK	-1 to 50 uA	1.3	2.1						
IQDD0	0 to 100 uA	0.038	0.036						
IQCC0	0 to 1000 uA	91.4	91.2						
IQBS0	0 to 1000 uA	75.9	75.2						
IHIN0	0 to 1 uA	0.013	0.013						
ILIN0	0 to 1 uA	0.013	0.013						
ISD0	0 to 1 uA	0.013	0.013						
IQDD1	0 to 100 uA	0.051	0.049						
IQCC1	0 to 1000 uA	100.3	99.4						
IQBS1	0 to 1000 uA	59.0	58.3						
IHIN1	0 to 70 uA	25.1	24.7						
ILIN1	0 to 70 uA	25.2	24.9						
ISD1	0 to 70 uA	25.0	24.6						
ILO+	2 to 5 A	2.8	2.8						
ILO-	2 to 5 A	3.1	3.1						
IHO+	2 to 5 A	2.6	2.6						
IHO-	2 to 5 A	3.3	3.3						
FN_15/15	1 to 1	1	1						
VOH_LS	0 to 1.2 V	0.324	0.325						
VOL_LS	-0.01 to 0.1 V	0	0						
VOL_HS	-0.01 to 0.1 V	0	0						
VOH_HS	0 to 1.2 V	0.299	0.306						
Vth+HS	6 to 9.5 V	8.0	8.0						
Vth-HS	6 to 9.5 V	6.4	6.3						
Vth+LS	6 to 9.5 V	8.0	8.0						
Vth-LS	6 to 9.5 V	6.3	6.3						
Vth+SD	6 to 9.5 V	8.4	8.4						
TON_LS	50 to 200 ns	117.3	116.9						
TOFF_LS	50 to 200 ns	109.0	108.5						
TR_LS	2 to 35 ns	8.2	8.1						
TF_LS	2 to 25 ns	6.1	6.4						
TON_HS	50 to 150 ns	114.4	115.3						
TOFF_HS	50 to 200 ns	105.3	106.3						
TR_HS	2 to 35 ns	10.5	10.1						
TF_HS	2 to 25 ns	8.3	7.9						
TSD_LS	50 to 140 ns	107.3	107.1						
TSD_HS	50 to 140 ns	108.1	108.6						
MT_ON	0 to 20 ns	2.9	1.6						
MT_OFF	0 to 20 ns	3.7	2.2						
VCCUV+pa	7.4 to 9.6 V	9.2	9.3						
VCCUV-pa	7 to 9.4 V	9.0	9.0						
VBSUV+pa	7.5 to 9.7 V	8.3	8.3						
VBSUV-pa	7 to 9.4 V	8.1	8.1						
IQDD1	0 to 30 uA	0.049	0.048						
IQCC1	0 to 340 uA	100.1	99.1						
IQBS1	0 to 230 uA	58.9	58.4						
D_IQDD1	0 to 3 uA	0.001	0.001						
D_IQCC1	0 to 30 uA	0.250	0.375						
D_IQBS1	0 to 20 uA	0.063	0.125						

INTERNATIONAL RECTIFIER  
EL SEGUNDO, CALIFORNIA

## Appendix B6

Post Accelerated Aging, Static Bias  
Electrical



**INTERNATIONAL RECTIFIER  
EL SEGUNDO, CALIFORNIA  
TEST SUMMARY**

CUSTOMER: IR  
 DEVICE : RIC7113L4  
 SPEC NO. : DOC:71-9837-17 REV:06 (c)SZ  
 JOB NO. : N/A

L.D.C. : 0007  
 LOT NO: B7607A  
 DATE : 3-17-00  
 Location: Static Bias, E2, Post 168 hr.  
 Aging

<b>Total Units Tested: 32</b>	<b>Total units Passed: 32</b>	<b>Electrical Yield: %100.00</b>
-------------------------------	-------------------------------	----------------------------------

TESTS	Failed Qty	% Loss	Failed Serial Numbers
CONT_OPN			
DIOD_SHT			
V_MAX			
I_LEAK			
IQDD0			
IQCC0			
IQBS0			
IHIN0			
ILIN0			
ISD0			
IQDD1			
IQCC1			
IQBS1			
IHIN1			
ILIN1			
ISD1			
ILO+			
ILO-			
IHO+			
IHO-			
FN_15/15			
VOH_LS			
VOL_LS			
VOL_HS			
VOH_HS			
Vth+HS			
Vth-HS			
Vth+LS			
Vth-LS			
Vth+SD			
TON_LS			
TOFF_LS			
TR_LS			
TF_LS			
TON_HS			
TOFF_HS			
TR_HS			
TF_HS			
TSD_LS			
TSD_HS			
MT_ON			
MT_OFF			
VCCUV+pa			
VCCUV-pa			
VBSUV+pa			
VBSUV-pa			
IQDD1			
IQCC1			
IQBS1			
D_IQDD1			
D_IQCC1			
D_IQBS1			

**INTERNATIONAL RECTIFIER  
EL SEGUNDO, CALIFORNIA**

CUSTOMER: IR  
 DEVICE : RIC7113L4  
 SPEC NO. : DOC:71-9837-17 REV:06 (c)SZ  
 JOB NO. : N/A

L.D.C. : 0007  
 LOT NO: B7607A  
 DATE : 3-17-00  
 Location: Static Bias, E2, Post 168 hr. Aging

TESTS	LIMITS	3	4	5	6	12	16	17	18	21	22
CONT_OPN	0 to 0	0	0	0	0	0	0	0	0	0	0
DIOD_SHT	0 to 0	0	0	0	0	0	0	0	0	0	0
V_MAX	425 to 990 V	N/A	N/A	N/A	N/A	N/A	N/A	N/A	N/A	N/A	N/A
I_LEAK	-1 to 50 uA	1.9	1.5	1.8	1.8	1.6	1.7	1.3	1.6	1.6	1.6
IQDD0	0 to 150 uA	0.036	0.034	0.036	0.035	0.038	0.033	0.031	0.036	0.036	0.036
IQCC0	0 to 1000 uA	81.6	80.9	109.8	81.2	83.7	85.0	84.1	84.0	81.7	79.7
IQBS0	0 to 230 uA	64.8	64.1	63.3	64.4	73.3	74.0	72.2	73.1	64.1	62.9
IHIN0	0 to 1 uA	0.013	0.013	0.013	0.013	0.013	0.013	0.013	0.013	0.013	0.013
ILIN0	0 to 1 uA	0.013	0.013	0.013	0.013	0.013	0.014	0.013	0.013	0.013	0.013
ISD0	0 to 1 uA	0.013	0.012	0.013	0.012	0.013	0.013	0.013	0.013	0.013	0.013
IQDD1	0 to 150 uA	0.049	0.048	0.048	0.046	0.048	0.046	0.047	0.048	0.045	0.047
IQCC1	0 to 1000 uA	89.8	89.0	121.4	88.9	92.4	93.7	92.6	92.0	89.6	88.0
IQBS1	0 to 230 uA	48.1	48.1	46.9	48.9	55.9	56.9	55.1	55.4	47.6	47.0
IHIN1	0 to 40 uA	24.3	23.7	24.4	23.6	24.9	25.1	24.7	24.5	24.5	23.6
ILIN1	0 to 40 uA	24.6	24.1	24.6	24.0	25.2	25.4	25.1	24.9	24.8	23.9
ISD1	0 to 40 uA	24.3	23.8	24.2	23.7	24.9	25.1	24.7	24.4	24.4	23.7
ILO+	2 to 5 A	2.6	2.6	2.5	2.7	3.0	3.0	3.0	3.0	2.5	2.5
ILO-	2 to 5 A	2.9	3.0	2.9	3.0	3.3	3.3	3.3	3.3	2.8	2.8
IHO+	2 to 5 A	2.4	2.4	2.3	2.5	2.7	2.7	2.8	2.8	2.3	2.3
IHO-	2 to 5 A	3.2	3.2	3.1	3.2	3.5	3.5	3.5	3.5	3.1	3.1
FN_15/15	1 to 1	1	1	1	1	1	1	1	1	1	1
VOH_LS	0 to 1.2 V	0.261	0.276	0.281	0.269	0.220	0.221	0.234	0.233	0.284	0.291
VOL_LS	-0.01 to 0.1 V	0	0	0	0	0	0	0	0	0	0
VOL_HS	-0.01 to 0.1 V	0	0	0	0	0	0	0	0	0	0
VOH_HS	0 to 1.2 V	0.242	0.256	0.261	0.251	0.206	0.204	0.216	0.216	0.267	0.274
Vth+HS	6 to 9.5 V	8.0	8.0	8.0	8.0	8.1	8.1	8.2	8.1	8.0	8.0
Vth-HS	6 to 9.5 V	6.4	6.5	6.4	6.4	6.7	6.7	6.7	6.7	6.4	6.4
Vth+LS	6 to 9.5 V	8.0	8.0	8.0	8.0	8.1	8.1	8.1	8.1	8.0	8.0
Vth-LS	6 to 9.5 V	6.4	6.4	6.4	6.4	6.6	6.6	6.6	6.6	6.4	6.4
Vth+SD	6 to 9.5 V	8.0	8.0	8.0	8.0	8.1	8.1	8.1	8.1	8.0	8.0
TON_LS	50 to 200 ns	138.6	139.0	148.5	134.7	114.1	112.9	113.7	112.8	135.8	135.2
TOFF_LS	50 to 200 ns	133.8	133.5	140.3	130.8	113.5	112.6	113.3	111.8	128.2	127.4
TR_LS	2 to 35 ns	7.5	7.9	7.9	7.4	7.6	7.3	7.4	7.6	8.5	8.4
TF_LS	2 to 25 ns	6.5	6.0	5.7	6.0	7.9	8.8	6.5	7.9	7.2	6.6
TON_HS	50 to 200 ns	133.6	133.0	142.3	130.1	108.9	107.8	108.9	107.2	136.7	133.8
TOFF_HS	50 to 200 ns	122.2	122.1	129.1	119.8	102.8	101.9	102.9	101.6	122.3	120.1
TR_HS	2 to 35 ns	10.7	10.9	10.4	10.7	11.4	11.6	11.2	11.1	9.6	9.9
TF_HS	2 to 25 ns	9.0	9.3	9.0	8.7	8.7	8.4	8.8	8.3	8.5	12.2
TSD_LS	50 to 200 ns	134.1	133.6	140.5	130.8	113.7	112.7	114.1	112.1	127.1	126.1
TSD_HS	50 to 200 ns	124.9	124.4	132.0	122.2	104.6	103.7	105.1	103.4	125.4	122.3
MT_ON	0 to 20 ns	5.0	6.1	6.3	4.6	5.2	5.2	4.7	5.6	0.880	1.4
MT_OFF	0 to 20 ns	11.5	11.4	11.3	11	10.7	10.6	10.4	10.2	5.9	7.2
VCCUV+pa	7.4 to 9.6 V	9.2	9.2	9.2	9.2	9.2	9.2	9.2	9.2	9.2	9.3
VCCUV-pa	7 to 9.4 V	9.0	9.0	9.0	8.9	8.9	8.9	8.9	8.9	9.0	9.0
VBSUV+pa	7.5 to 9.7 V	8.2	8.2	8.3	8.3	8.3	8.3	8.3	8.3	8.3	8.3
VBSUV-pa	7 to 9.4 V	7.9	7.9	8.1	8.0	8.1	8.1	8.1	8.1	8.0	8.0
IQDD1	0 to 30 uA	0.045	0.047	0.046	0.045	0.049	0.045	0.048	0.046	0.045	0.048
IQCC1	0 to 340 uA	89.6	89.1	121.3	88.7	92.3	93.4	92.4	91.8	89.9	87.7
IQBS1	0 to 230 uA	48.3	48.5	47.0	48.6	55.9	56.9	54.8	55.6	47.3	46.9
D_IQDD1	0 to 3 uA	0.004	0	0.002	0.001	0.001	0.001	0	0.003	0	0.001
D_IQCC1	0 to 30 uA	0.188	0.063	0.063	0.250	0.188	0.250	0.188	0.250	0.375	0.313
D_IQBS1	0 to 20 uA	0.188	0.375	0.125	0.250	0	0	0.250	0.250	0.313	0.125

**INTERNATIONAL RECTIFIER  
EL SEGUNDO, CALIFORNIA**

CUSTOMER: IR  
 DEVICE : RIC7113L4  
 SPEC NO. : DOC:71-9837-17 REV:06 (c)SZ  
 JOB NO. : N/A

L.D.C. : 0007  
 LOT NO: B7607A  
 DATE : 3-17-00  
 Location: Static Bias, E2, Post 168 hr. Aging

TESTS	LIMITS	26	27	34	35	36	37	44	45	46	47
CONT_OPN	0 to 0	0	0	0	0	0	0	0	0	0	0
DIOD_SHT	0 to 0	0	0	0	0	0	0	0	0	0	0
V_MAX	425 to 990 V	N/A	N/A	N/A	N/A	N/A	N/A	N/A	N/A	N/A	N/A
I_LEAK	-1 to 50 uA	1.1	2.0	1.6	1.1	1.9	1.1	1.5	1.5	1.7	1.4
IQDD0	0 to 150 uA	0.036	0.034	0.033	0.034	0.038	0.034	0.033	0.036	0.038	0.034
IQCC0	0 to 1000 uA	81.8	79.8	83.1	81.8	81.6	82.2	89.7	87.6	87.0	89.4
IQBS0	0 to 230 uA	64.4	62.8	68.4	67.4	67.4	67.8	68.1	68.3	67.3	68.7
IHIN0	0 to 1 uA	0.013	0.013	0.013	0.013	0.013	0.013	0.014	0.013	0.013	0.013
ILIN0	0 to 1 uA	0.013	0.013	0.013	0.013	0.013	0.013	0.014	0.013	0.013	0.013
ISD0	0 to 1 uA	0.013	0.012	0.013	0.012	0.012	0.013	0.013	0.013	0.013	0.013
IQDD1	0 to 150 uA	0.048	0.046	0.048	0.048	0.049	0.047	0.046	0.048	0.046	0.046
IQCC1	0 to 1000 uA	90.2	87.8	91.2	89.8	89.7	90.3	98.1	95.9	94.9	97.8
IQBS1	0 to 230 uA	47.1	46.6	51.6	51.3	51.4	51.7	51.3	51.4	50.7	51.4
IHIN1	0 to 40 uA	24.5	23.7	24.2	23.8	24.0	24.1	25.0	24.4	24.0	24.9
ILIN1	0 to 40 uA	24.8	23.9	24.6	24.1	24.2	24.5	25.5	24.7	24.4	25.2
ISD1	0 to 40 uA	24.5	23.6	24.3	23.9	24.0	24.2	25.1	24.4	24.1	24.9
ILO+	2 to 5 A	2.5	2.5	2.8	2.8	2.8	2.8	2.4	2.5	2.4	2.4
ILO-	2 to 5 A	2.9	2.8	3.1	3.1	3.1	3.1	2.7	2.8	2.7	2.7
IHO+	2 to 5 A	2.3	2.3	2.5	2.5	2.6	2.6	2.2	2.3	2.3	2.2
IHO-	2 to 5 A	3.1	3.1	3.3	3.3	3.3	3.3	2.9	3.0	2.9	2.9
FN_15/15	1 to 1	1	1	1	1	1	1	1	1	1	1
VOH_LS	0 to 1.2 V	0.283	0.296	0.259	0.265	0.264	0.263	0.361	0.368	0.374	0.377
VOL_LS	-0.01 to 0.1 V	0	0	0	0	0	0	0	0	0	0
VOL_HS	-0.01 to 0.1 V	0	0	0	0	0	0	0	0	0	0
VOH_HS	0 to 1.2 V	0.265	0.273	0.244	0.249	0.249	0.247	0.343	0.351	0.353	0.359
Vth+HS	6 to 9.5 V	8.1	8.1	8.1	8.1	8.1	8.1	8.2	8.2	8.2	8.2
Vth-HS	6 to 9.5 V	6.4	6.4	6.5	6.5	6.6	6.5	6.5	6.5	6.5	6.5
Vth+LS	6 to 9.5 V	8.0	8.0	8.1	8.1	8.1	8.1	8.2	8.2	8.2	8.2
Vth-LS	6 to 9.5 V	6.4	6.4	6.5	6.5	6.5	6.5	6.4	6.5	6.4	6.4
Vth+SD	6 to 9.5 V	8.0	8.1	8.1	8.1	8.1	8.1	8.2	8.2	8.2	8.2
TON_LS	50 to 200 ns	136.5	137.2	119.7	119.0	118.3	118.3	152.6	146.5	149.9	149.0
TOFF_LS	50 to 200 ns	128.8	128.5	114.4	115.2	115.0	113.9	143.7	138.7	142.2	139.5
TR_LS	2 to 35 ns	8.1	8.4	8.8	8.8	8.5	8.8	8.0	8.1	8.3	8.2
TF_LS	2 to 25 ns	7.0	7.1	6.6	6.5	6.4	6.4	6.7	6.6	6.6	6.6
TON_HS	50 to 200 ns	137.4	135.2	118.5	118.2	117.1	117.2	148.9	143.6	147.3	146.0
TOFF_HS	50 to 200 ns	123.1	121.0	107.2	107.1	106.9	106.3	135.3	131	134.1	132.2
TR_HS	2 to 35 ns	9.4	10.2	9.8	9.8	10.0	9.8	10.6	10.5	10.0	10.3
TF_HS	2 to 25 ns	9.2	11.6	9.1	8.6	9.0	9.7	11.4	11.7	12.2	12.2
TSD_LS	50 to 200 ns	127.5	127.6	113.2	114.5	113.0	112.9	143.1	138.4	141.5	139.4
TSD_HS	50 to 200 ns	126.2	124.3	109.7	109.8	108.5	108.5	138.7	133.8	137.5	135.6
MT_ON	0 to 20 ns	0.880	1.9	1.3	0.820	1.2	1.1	3.8	2.9	2.5	3.0
MT_OFF	0 to 20 ns	5.7	7.6	7.2	8.1	8.0	7.6	8.4	7.8	8.1	7.3
VCCUV+pa	7.4 to 9.6 V	9.3	9.3	9.2	9.2	9.2	9.2	9.2	9.3	9.3	9.2
VCCUV-pa	7 to 9.4 V	9.0	9.0	8.9	8.9	9.0	8.9	8.9	9.0	9.0	8.9
VBSUV+pa	7.5 to 9.7 V	8.2	8.3	8.2	8.3	8.2	8.3	8.3	8.3	8.3	8.3
VBSUV-pa	7 to 9.4 V	8.0	8.0	8.0	8.1	7.9	8.0	8.0	8.0	8.0	8.1
IQDD1	0 to 30 uA	0.046	0.047	0.048	0.046	0.046	0.045	0.043	0.046	0.046	0.044
IQCC1	0 to 340 uA	89.7	87.8	91.1	89.8	89.9	90.1	98.1	95.9	94.8	97.8
IQBS1	0 to 230 uA	47.1	46.3	51.5	51.2	51.2	51.4	51.2	51.5	50.8	51.6
D_IQDD1	0 to 3 uA	0.003	0.001	0	0.001	0.003	0.002	0.003	0.001	0	0.002
D_IQCC1	0 to 30 uA	0.500	0.063	0.063	0	0.250	0.125	0.063	0	0.125	0.063
D_IQBS1	0 to 20 uA	0	0.250	0.063	0.063	0.250	0.313	0.125	0.063	0.125	0.125

**INTERNATIONAL RECTIFIER  
EL SEGUNDO, CALIFORNIA**

CUSTOMER: IR  
 DEVICE : RIC7113L4  
 SPEC NO. : DOC:71-9837-17 REV:06 (c)SZ  
 JOB NO. : N/A

L.D.C. : 0007  
 LOT NO: B7607A  
 DATE : 3-17-00  
 Location: Static Bias, E2, Post 168 hr. Aging

TESTS	LIMITS	50	51	52	54	58	59	60	61	68	69
CONT_OPN	0 to 0	0	0	0	0	0	0	0	0	0	0
DIOD_SHT	0 to 0	0	0	0	0	0	0	0	0	0	0
V_MAX	425 to 990 V	N/A	N/A	N/A	N/A	N/A	N/A	N/A	N/A	N/A	N/A
I_LEAK	-1 to 50 uA	1.5	1.7	1.5	1.8	1.4	1.6	1.6	1.5	2.1	1.7
IQDD0	0 to 150 uA	0.035	0.033	0.034	0.034	0.034	0.031	0.033	0.033	0.033	0.033
IQCC0	0 to 1000 uA	86.4	90.8	90.8	87.4	84.1	84.3	85.4	84.2	89.9	89.6
IQBS0	0 to 230 uA	73.0	72.6	72.9	72.7	65.5	66.4	64.8	65.1	76.1	75.3
IHIN0	0 to 1 uA	0.013	0.013	0.013	0.013	0.013	0.013	0.012	0.013	0.013	0.013
ILIN0	0 to 1 uA	0.013	0.013	0.013	0.013	0.013	0.013	0.012	0.013	0.013	0.013
ISD0	0 to 1 uA	0.012	0.013	0.013	0.012	0.012	0.012	0.012	0.012	0.013	0.013
IQDD1	0 to 150 uA	0.048	0.048	0.047	0.046	0.046	0.048	0.046	0.044	0.047	0.045
IQCC1	0 to 1000 uA	93.5	96.6	97.8	95.4	91.5	91.8	93.0	91.8	98.3	98.2
IQBS1	0 to 230 uA	56.9	56.4	56.8	56.4	50.5	51.0	49.6	50.2	59.1	58.9
IHIN1	0 to 40 uA	23.7	24.1	24.2	24.0	23.3	23.2	23.3	23.2	24.6	24.6
ILIN1	0 to 40 uA	23.6	24.4	24.3	24.3	23.5	23.5	23.6	23.5	24.9	24.8
ISD1	0 to 40 uA	23.4	24.2	24.2	24.0	23.3	23.1	23.3	23.2	24.7	24.6
ILO+	2 to 5 A	2.8	2.7	2.7	2.8	2.5	2.6	2.5	2.5	2.8	2.8
ILO-	2 to 5 A	3.1	3.0	3.0	3.1	2.8	2.9	2.8	2.8	3.1	3.1
IHO+	2 to 5 A	2.6	2.5	2.5	2.6	2.3	2.4	2.3	2.4	2.6	2.6
IHO-	2 to 5 A	3.3	3.2	3.2	3.3	3.1	3.1	3.1	3.1	3.3	3.3
FN_15/15	1 to 1	1	1	1	1	1	1	1	1	1	1
VOH_LS	0 to 1.2 V	0.326	0.346	0.336	0.325	0.359	0.354	0.361	0.361	0.322	0.316
VOL_LS	-0.01 to 0.1 V	0	0	0	0	0	0	0	0	0	0
VOL_HS	-0.01 to 0.1 V	0	0	0	0	0	0	0	0	0	0
VOH_HS	0 to 1.2 V	0.308	0.327	0.316	0.308	0.337	0.334	0.342	0.341	0.302	0.294
Vth+HS	6 to 9.5 V	8.2	8.2	8.2	8.2	8.2	8.2	8.2	8.2	8.2	8.2
Vth-HS	6 to 9.5 V	6.7	6.6	6.6	6.7	6.5	6.5	6.5	6.5	6.6	6.6
Vth+LS	6 to 9.5 V	8.2	8.2	8.2	8.2	8.2	8.2	8.2	8.2	8.2	8.2
Vth-LS	6 to 9.5 V	6.6	6.6	6.6	6.6	6.5	6.5	6.5	6.5	6.6	6.6
Vth+SD	6 to 9.5 V	8.2	8.1	8.2	8.2	8.2	8.2	8.2	8.2	8.2	8.2
TON_LS	50 to 200 ns	119.3	125.7	125.6	123.2	139.1	138.4	139.6	138.6	117.6	116.5
TOFF_LS	50 to 200 ns	116.4	121.9	121.9	119.6	129.2	128.7	128.8	128.4	111.5	111.1
TR_LS	2 to 35 ns	8.7	7.6	7.7	7.7	8.4	8.4	8.1	8.5	8.3	8.6
TF_LS	2 to 25 ns	6.3	5.9	5.8	5.9	7.0	6.4	7.0	6.9	7.2	6.6
TON_HS	50 to 200 ns	117.3	121.5	121.2	118.4	139.0	138.7	138.3	138.5	115.9	114.8
TOFF_HS	50 to 200 ns	108.6	111.5	111.3	109.7	125.2	124.6	124.5	124.2	105.9	105.6
TR_HS	2 to 35 ns	10.3	11.1	11.3	11.1	9.7	9.7	10.0	9.8	10.4	10.4
TF_HS	2 to 25 ns	10.2	10.2	10.5	10.4	9.3	8.8	8.9	9.0	8.9	8.8
TSD_LS	50 to 200 ns	115.0	120.8	120.8	118.9	128.5	126.9	128.0	127.2	110.1	109.4
TSD_HS	50 to 200 ns	110.9	114.2	114.1	112.1	129.1	127.7	128.2	127.9	108.5	108.2
MT_ON	0 to 20 ns	1.9	4.2	4.4	4.8	0.130	0.290	1.3	0.080	1.8	1.7
MT_OFF	0 to 20 ns	7.8	10.4	10.5	9.9	4.0	4.0	4.3	4.2	5.6	5.5
VCCUV+pa	7.4 to 9.6 V	9.3	9.3	9.2	9.3	9.2	9.2	9.2	9.1	9.2	9.3
VCCUV-pa	7 to 9.4 V	9.0	9.0	9.0	9.0	8.9	8.9	8.9	8.9	9.0	9.0
VBSUV+pa	7.5 to 9.7 V	8.3	8.3	8.3	8.3	8.3	8.3	8.3	8.3	8.3	8.4
VBSUV-pa	7 to 9.4 V	8.1	8.1	8.1	8.1	8.0	8.0	8.1	8.0	8.1	8.1
IQDD1	0 to 30 uA	0.046	0.044	0.046	0.045	0.044	0.045	0.046	0.045	0.044	0.043
IQCC1	0 to 340 uA	93.6	96.4	97.6	95.4	91.6	91.9	93.0	91.8	98.2	98.1
IQBS1	0 to 230 uA	56.8	56.3	56.9	56.1	50.3	51.1	49.9	50.2	59.1	58.8
D_IQDD1	0 to 3 uA	0.002	0.004	0	0	0.002	0.003	0	0	0.003	0.002
D_IQCC1	0 to 30 uA	0.063	0.188	0.125	0.063	0.063	0.063	0	0	0.125	0.125
D_IQBS1	0 to 20 uA	0.125	0.063	0.125	0.375	0.188	0.063	0.313	0	0	0.063

**INTERNATIONAL RECTIFIER  
EL SEGUNDO, CALIFORNIA**

CUSTOMER: IR  
 DEVICE : RIC7113L4  
 SPEC NO. : DOC:71-9837-17 REV:06 (c)SZ  
 JOB NO. : N/A

L.D.C. : 0007  
 LOT NO: B7607A  
 DATE : 3-17-00  
 Location: Static Bias, E2, Post 168 hr. Aging

TESTS	LIMITS	70	73							
CONT_OPN	0 to 0	0	0							
DIOD_SHT	0 to 0	0	0							
V_MAX	425 to 990 V	N/A	N/A							
I_LEAK	-1 to 50 uA	1.5	1.6							
IQDD0	0 to 150 uA	0.033	0.034							
IQCC0	0 to 1000 uA	89.0	89.9							
IQBS0	0 to 230 uA	74.1	74.0							
IHIN0	0 to 1 uA	0.013	0.013							
ILIN0	0 to 1 uA	0.013	0.013							
ISD0	0 to 1 uA	0.013	0.013							
IQDD1	0 to 150 uA	0.045	0.046							
IQCC1	0 to 1000 uA	97.3	98.6							
IQBS1	0 to 230 uA	57.6	57.3							
IHIN1	0 to 40 uA	24.4	24.5							
ILIN1	0 to 40 uA	24.7	24.8							
ISD1	0 to 40 uA	24.4	24.6							
ILO+	2 to 5 A	2.8	2.8							
ILO-	2 to 5 A	3.1	3.1							
IHO+	2 to 5 A	2.6	2.6							
IHO-	2 to 5 A	3.3	3.3							
FN_15/15	1 to 1	1	1							
VOH_LS	0 to 1.2 V	0.316	0.317							
VOL_LS	-0.01 to 0.1 V	0	0							
VOL_HS	-0.01 to 0.1 V	0	0							
VOH_HS	0 to 1.2 V	0.297	0.300							
Vth+HS	6 to 9.5 V	8.2	8.2							
Vth-HS	6 to 9.5 V	6.6	6.6							
Vth+LS	6 to 9.5 V	8.2	8.2							
Vth-LS	6 to 9.5 V	6.6	6.6							
Vth+SD	6 to 9.5 V	8.2	8.2							
TON_LS	50 to 200 ns	117.6	116.5							
TOFF_LS	50 to 200 ns	111.8	110.8							
TR_LS	2 to 35 ns	8.5	8.8							
TF_LS	2 to 25 ns	7.0	6.9							
TON_HS	50 to 200 ns	115.3	115.4							
TOFF_HS	50 to 200 ns	105.8	105.3							
TR_HS	2 to 35 ns	10.3	10.0							
TF_HS	2 to 25 ns	9.5	8.6							
TSD_LS	50 to 200 ns	110.8	109.8							
TSD_HS	50 to 200 ns	108.0	108.9							
MT_ON	0 to 20 ns	2.3	1.1							
MT_OFF	0 to 20 ns	6.0	5.5							
VCCUV+pa	7.4 to 9.6 V	9.3	9.3							
VCCUV-pa	7 to 9.4 V	9.0	9.0							
VBSUV+pa	7.5 to 9.7 V	8.4	8.3							
VBSUV-pa	7 to 9.4 V	8.1	8.1							
IQDD1	0 to 30 uA	0.048	0.043							
IQCC1	0 to 340 uA	97.4	98.4							
IQBS1	0 to 230 uA	57.6	57.3							
D_IQDD1	0 to 3 uA	0.003	0.003							
D_IQCC1	0 to 30 uA	0.188	0.250							
D_IQBS1	0 to 20 uA	0	0.063							

INTERNATIONAL RECTIFIER  
EL SEGUNDO, CALIFORNIA

Appendix C  
Post 500Krad  
Electrical

**INTERNATIONAL RECTIFIER  
EL SEGUNDO, CALIFORNIA  
TEST SUMMARY**

CUSTOMER: IR  
 DEVICE : RIC7113L4  
 SPEC NO. : DOC:71-9837-17 REV:06 (c)SZ  
 JOB NO. : N/A

L.D.C. : 0007  
 LOT NO: B7607A  
 DATE : 3-17-00  
 Location: Post 500krad, S&D Bias, post  
 168 hr. Ageing

<b>Total Units Tested: 8</b>	<b>Total units Passed: 0</b>	<b>Electrical Yield: %0.00</b>
------------------------------	------------------------------	--------------------------------

TESTS	Failed Qty	% Loss	Failed Serial Numbers
CONT_OPN			
DIOD_SHT			
V_MAX			
I_LEAK			
IQDD0			
IQCC0			
IQBS0			
IHIN0			
ILIN0			
ISD0			
IQDD1			
IQCC1			
IQBS1			
IHIN1			
ILIN1			
ISD1			
ILO+			
ILO-			
IHO+			
IHO-			
FN_15/15	4	%50.00	2,11,31,39
VOH_LS			
VOL_LS			
VOL_HS			
VOH_HS			
Vth+HS			
Vth-HS			
Vth+LS			
Vth-LS			
Vth+SD			
TON_LS			
TOFF_LS			
TR_LS			
TF_LS			
TON_HS			
TOFF_HS			
TR_HS			
TF_HS			
TSD_LS			
TSD_HS			
MT_ON			
MT_OFF			
VCCUV+pa	4	%50.00	43,48,56,71
VCCUV-pa			
VBSUV+pa			
VBSUV-pa			
IQDD1			
IQCC1			
IQBS1			
D_IQDD1			
D_IQCC1			
D_IQBS1			

**INTERNATIONAL RECTIFIER  
EL SEGUNDO, CALIFORNIA**

CUSTOMER: IR  
 DEVICE : RIC7113L4  
 SPEC NO. : DOC:71-9837-17 REV:06 (c)SZ  
 JOB NO. : N/A

L.D.C. : 0007  
 LOT NO: B7607A  
 DATE : 3-17-00  
 Location: Post 500krad, S&D Bias, post 168 hr. Ageing

TESTS	LIMITS	2 [F]	11 [F]	31 [F]	39 [F]	43 [F]	48 [F]	56 [F]	71 [F]	
CONT_OPN	0 to 0	0	0	0	0	0	0	0	0	
DIOD_SHT	0 to 0	0	0	0	0	0	0	0	0	
V_MAX	425 to 990 V	N/A	N/A	N/A	N/A	N/A	N/A	N/A	N/A	
I_LEAK	-1 to 50 uA	1.4	1.4	2.0	1.6	1.5	1.4	1.6	1.5	
IQDD0	0 to 100 uA	0.042	0.039	0.043	0.038	0.036	0.036	0.035	0.037	
IQCC0	0 to 1000 uA	73.1	74.8	73.3	83.6	82.8	82.4	85.6	83.7	
IQBS0	0 to 1000 uA	61.9	67.1	63.4	64.8	65.5	70.9	71.0	70.9	
IHIN0	0 to 1 uA	0.013	0.013	0.013	0.013	0.013	0.013	0.013	0.013	
ILIN0	0 to 1 uA	0.013	0.013	0.013	0.013	0.013	0.013	0.013	0.014	
ISD0	0 to 1 uA	0.012	0.013	0.012	0.013	0.013	0.013	0.013	0.013	
IQDD1	0 to 100 uA	0.051	0.052	0.051	0.051	0.050	0.049	0.047	0.049	
IQCC1	0 to 1000 uA	80.9	82.9	81.2	91.9	91.3	90.3	92.6	92.0	
IQBS1	0 to 1000 uA	46.0	50.1	47.4	48.0	48.6	54.6	55.2	54.2	
IHIN1	0 to 70 uA	23.5	24.5	23.7	24.5	24.7	24.2	24.6	24.7	
ILIN1	0 to 70 uA	23.7	24.7	24.0	24.7	25.0	24.4	24.8	25.1	
ISD1	0 to 70 uA	23.5	24.4	23.7	24.3	24.7	24.2	24.6	24.8	
ILO+	2 to 5 A	2.5	2.8	2.7	2.4	2.4	2.7	2.6	2.7	
ILO-	2 to 5 A	2.8	3.1	2.9	2.6	2.5	2.9	2.8	2.9	
IHO+	2 to 5 A	2.4	2.6	2.5	2.2	2.2	2.5	2.4	2.5	
IHO-	2 to 5 A	3.1	3.3	3.1	2.8	2.8	3.1	3.0	3.1	
FN_15/15	1 to 1	0 F	0 F	0 F	0 F	1	1	1	1	
VOH_LS	0 to 1.2 V	0.292	0.254	0.285	0.388	0.367	0.330	0.331	0.322	
VOL_LS	-0.01 to 0.1 V	0	0	0	0	0	0	0	0	
VOL_HS	-0.01 to 0.1 V	0	0	0	0	0	0	0	0	
VOH_HS	0 to 1.2 V	0.249	0.220	0.255	0.340	0.350	0.314	0.320	0.308	
Vth+HS	6 to 9.5 V	7.6	7.7	7.7	7.8	8.0	8.0	8.0	8.0	
Vth-HS	6 to 9.5 V	5.7 F	6.0	5.8 F	5.7 F	6.2	6.4	6.3	6.4	
Vth+LS	6 to 9.5 V	7.6	7.6	7.6	7.7	8.0	8.0	8.0	8.0	
Vth-LS	6 to 9.5 V	5.7 F	5.9 F	5.8 F	5.7 F	6.2	6.3	6.3	6.3	
Vth+SD	6 to 9.5 V	8.2	8.3	8.3	8.4	8.0	8.0	8.0	8.0	
TON_LS	50 to 200 ns	139.4	116.6	119.1	148.9	152	123.4	127.3	116.7	
TOFF_LS	50 to 200 ns	138.8	119.8	119.8	144.8	150.4	128.2	131.6	119.7	
TR_LS	2 to 50 ns	8.6	7.7	8.3	8.6	8.4	8.4	8.4	8.7	
TF_LS	2 to 50 ns	5.9	5.9	7.1	7.4	7.1	5.7	5.9	6.4	
TON_HS	50 to 200 ns	136.3	-100180	-100180	147.8	150.3	123.7	127.3	119.9	
TOFF_HS	50 to 200 ns	128.4	109.6	113.2	138.9	140.4	117.3	120.7	112.0	
TR_HS	2 to 50 ns	10.6	10.4	8.9	9.8	10.0	9.9	10.0	8.9	
TF_HS	2 to 50 ns	10.0	8.7	10.7	10.2	10.1	9.8	9.7	9.3	
TSD_LS	50 to 200 ns	136.0	118.4	117.2	142.2	149.1	126.4	129.6	117.6	
TSD_HS	50 to 200 ns	129.1	109.1	113.7	140.6	142.5	118.5	121.5	113.4	
MT_ON	0 to 20 ns	3.1	100296	100298	1.1	1.7	0.330	0.060	3.2	
MT_OFF	0 to 20 ns	10.4	10.2	6.6	6.0	10.0	10.9	10.9	7.7	
VCCUV+pa	7.4 to 9.6 V	9.7 F	9.7 F	9.8 F	9.8 F	9.7 F	9.8 F	9.9 F	9.7 F	
VCCUV-pa	7 to 9.4 V	9.4	9.4	9.5 F	9.5 F	9.4	9.5 F	9.6 F	9.4	
VBSUV+pa	7.5 to 9.7 V	8.1	7.9	7.9	8.0	8.0	8.0	8.0	8.0	
VBSUV-pa	7 to 9.4 V	7.9	7.7	7.7	7.8	7.8	7.8	7.8	7.8	
IQDD1	0 to 100 uA	0.051	0.049	0.051	0.048	0.047	0.047	0.048	0.046	
IQCC1	0 to 1000 uA	80.8	82.7	81.1	91.9	90.9	90.1	92.4	92.0	
IQBS1	0 to 1000 uA	46.1	50.1	47.3	47.9	48.5	54.7	55.0	54.1	
D_IQDD1	0 to 3 uA	0	0.003	0	0.003	0.003	0.002	0	0.003	
D_IQCC1	0 to 30 uA	0.125	0.250	0.125	0	0.313	0.125	0.188	0	
D_IQBS1	0 to 20 uA	0.063	0	0.125	0.063	0.063	0.063	0.188	0.063	