

**Technical Data Sheet**  
**High Power LED – 0.5W****EHP-A09/UY31-PU5/TR****Features**

- Feature of the device: small package with high efficiency
- Typical view angle: 120°
- ESD protection
- Soldering methods: SMT
- Grouping parameter: luminous Intensity, wavelength, forward voltage
- Typical optical efficiency: 27 lm/W
- Thermal resistance (junction to sink): 65 K/W
- The product itself will remain within RoHS compliant version

**Applications**

- Interior and exterior automotive lighting (e.g. turn light and indicating sign)
- Warning signs applied
- Signal and symbol luminaries
- Portable light source
- Marker lights (e.g. steps, exit ways, etc.)

**Materials**

Items	Description
Reflector	Heat resistant polymer
Encapsulating Resin	Colorless clear resin
Electrodes	Ag plating
Die attach	Silver paste
Chip	AlGaInP

**EHP-A09/UY31-PU5/TR**

**Dimensions**

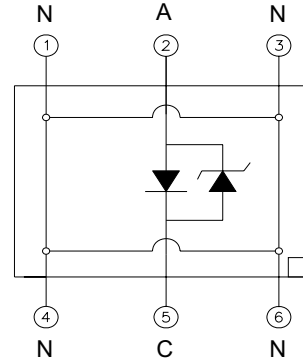
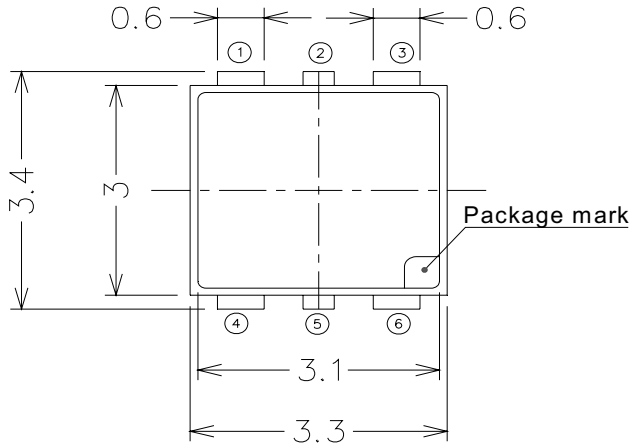

Polarity

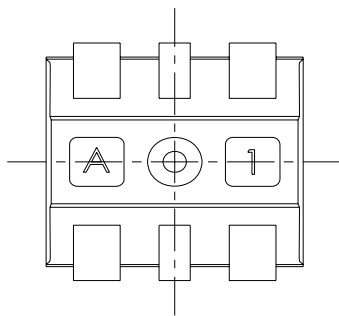
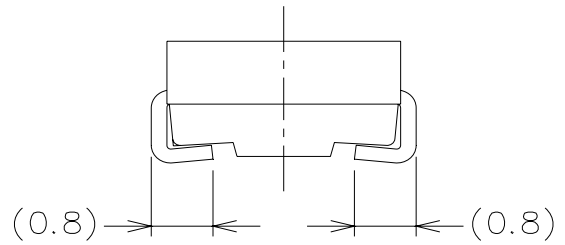
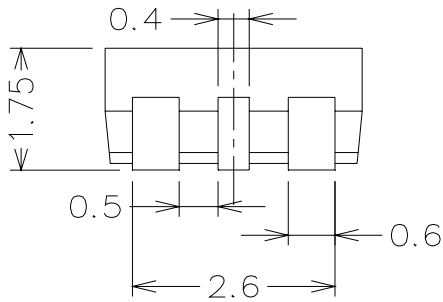

Bot. view

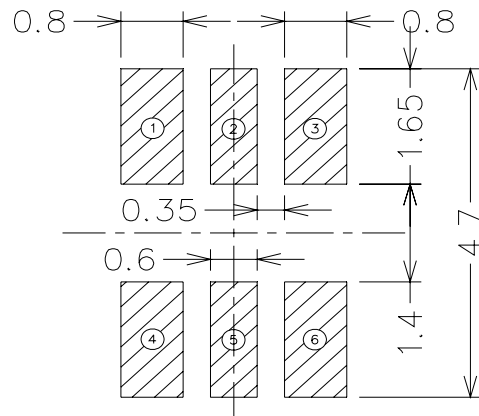

Soldering patterns

- Notes: 1. Dimensions are in millimeters.**
- 2. Tolerances unless dimensions  $\pm 0.25\text{mm}$ .**

**EHP-A09/UY31-PU5/TR**
**Maximum Ratings ( $T_{Ambient}=25^{\circ}C$ )**

Parameter	Symbol	Rating	Unit
DC Operating Current	$I_F$	150	mA
Pulsed Forward Current	$I_F$	300	mA
ESD Sensitivity	ESD	2000	V
Junction Temperature	$T_j$	125	$^{\circ}C$
Operating Temperature	$T_{opr}$	-40 ~ +100	$^{\circ}C$
Storage Temperature	$T_{stg}$	-40 ~ +100	$^{\circ}C$
Power Dissipation	$P_d$	0.5	W
Junction To Heat-Sink Thermal Resistance	$R_{th}$	65	K/W

**Electro-Optical Characteristics ( $T_{Ambient}=25^{\circ}C$ )**

Parameter	Bin	Symbol	Min	Typ.	Max	Unit	Condition
Luminous Intensity <sub>(1)</sub>	B2	$I_v$	2240	----	2800	mcd	$I_F=150mA$
	C1		2800	----	3550		
	C2		3550	----	4500		
	D1		4500	----	5600		
	D2		5600	----	7100		
Wavelength <sub>(2)</sub>	A3	$\lambda_d$	585	----	587.5	nm	
	A4		587.5	----	590		
	A5		590	----	592.5		
	A6		592.5	----	595		
Forward Voltage <sub>(3)</sub>	U2	$V_F$	2.05	----	2.35	V	
	U3		2.35	----	2.65		
	U4		2.65	----	2.95		
Viewing Angle <sub>(4)</sub>	----	$2\theta_{1/2}$	----	120	----	deg	

Note. 1. Luminous Intensity measurement tolerance:  $\pm 10\%$

2. Wavelength measurement tolerance :  $\pm 1nm$

3. Forward Voltage measurement tolerance:  $\pm 0.1V$

4.  $2\theta_{1/2}$  is the off axis angle from lamp centerline where the luminous intensity is 1/2 of the peak value.

**EHP-A09/UY31-PU5/TR**

Typical Electro-Optical Characteristics Curves

Relative Spectral Distribution,  
 $I_f=150\text{mA}$ ,  $T_{\text{Ambient}}=25^\circ\text{C}$

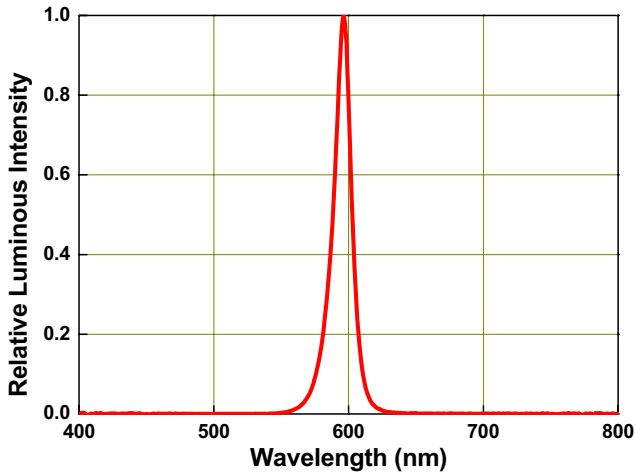

Forward Voltage vs Forward Current,  
 $T_{\text{Ambient}}=25^\circ\text{C}$

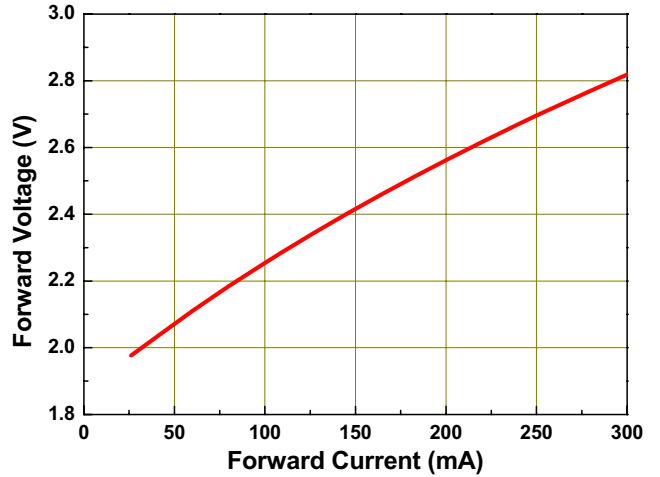

Relative Luminous Intensity vs Forward Current,  
 $T_{\text{Ambient}}=25^\circ\text{C}$

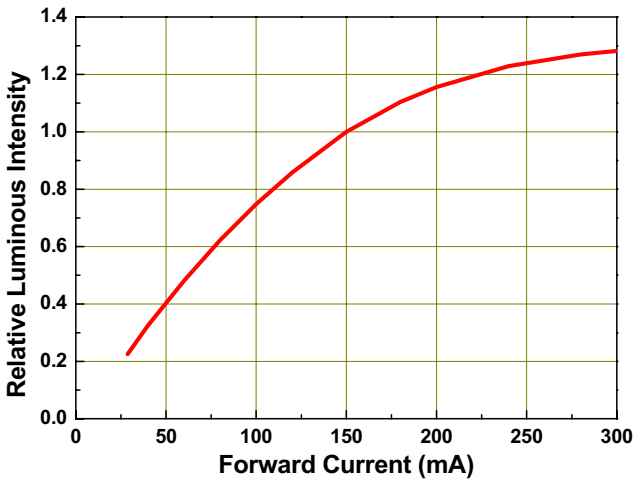

Ambient Temperature & Operating Current Derating based on  $T_{\text{JMAX}} = 125^\circ\text{C}$

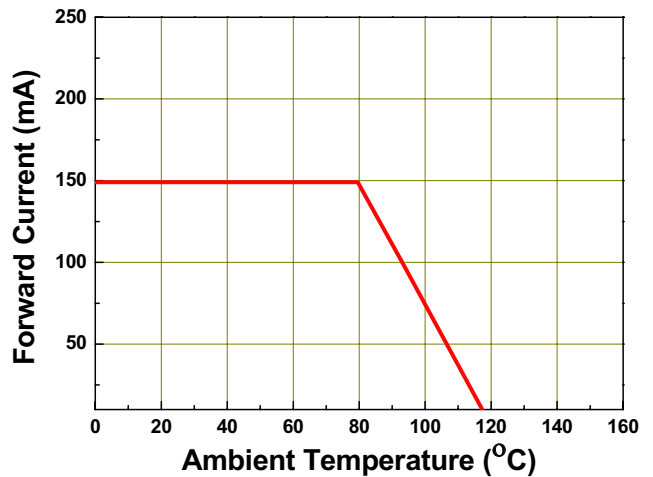

**Typical Representative Spatial Radiation Pattern**

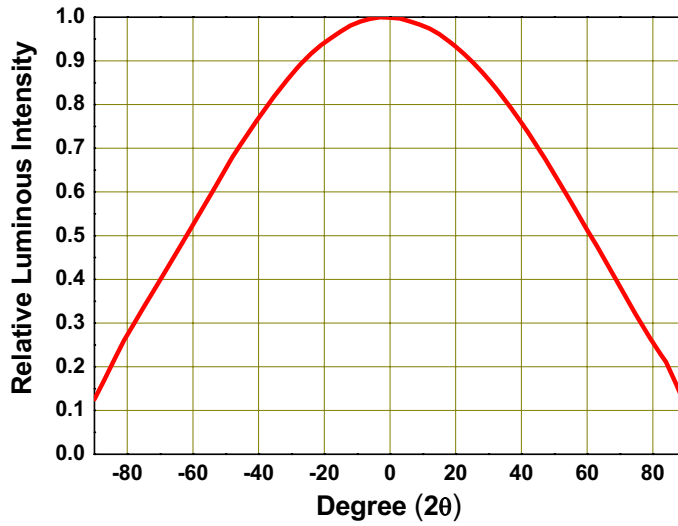

**EHP-A09/UY31-PU5/TR**

**Label explanation**

- CPN: Customer's Production Number**
- P/N : Production Number**
- QTY: Packing Quantity**
- CAT: Ranks**
- HUE: Domain Wavelength**
- REF: Reference**
- LOT No: Lot Number**
- MADE IN TAIWAN: Production Place**



**Reel Dimensions**

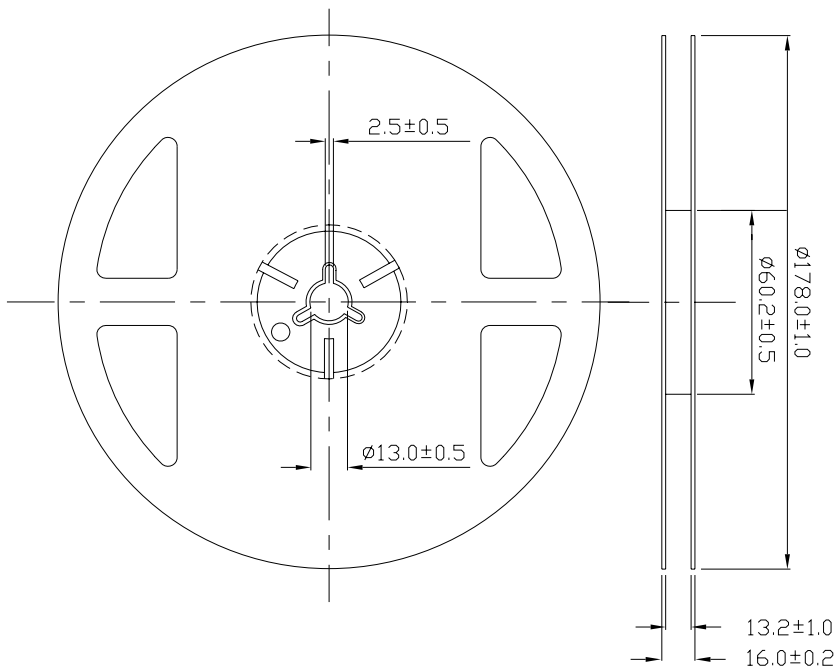

- Note: 1. Dimensions are in millimeters.**
- 2. The tolerances unless mentioned is ±0.1mm.**

**EHP-A09/UY31-PU5/TR**

Carrier Tape Dimensions: Loaded quantity 1000 PCS per reel

**Progress Direction**

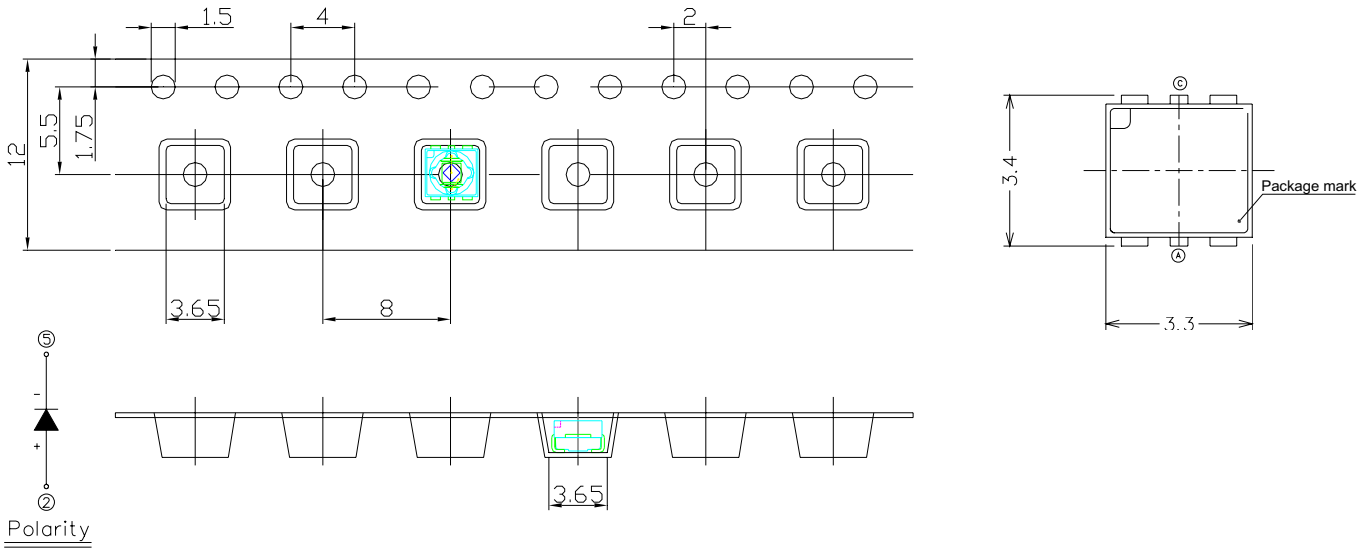

- Note:**
1. Dimensions are in millimeters.
  2. The tolerances unless mentioned is  $\pm 0.1\text{mm}$ .

**Moisture Resistant Packaging**

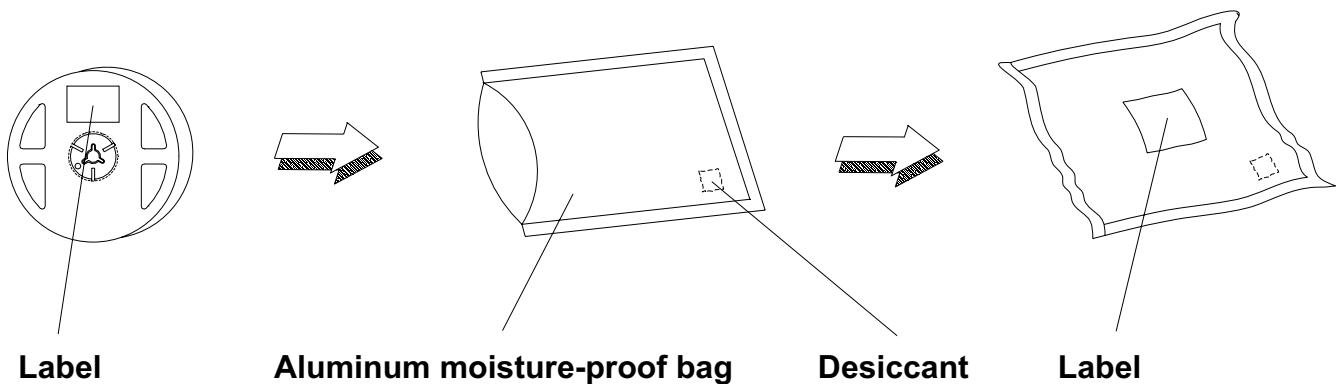

**EHP-A09/UY31-PU5/TR**
**Reliability Test Items**

Stress Test	Stress Condition	Stress Duration
Reflow	$T_{sol}=260^{\circ}\text{C}$ , 10sec, 6min(total)	2 times
DC Operating Life	$T_a=25^{\circ}\text{C}$ , $I_F=150\text{mA}$	1000 hours
High Temperature Storage	$T_a=100^{\circ}\text{C}$	1000 hours
High Temperature Operation Life #1	$T_a=55^{\circ}\text{C}$ , $I_F=150\text{mA}$	1000 hours
High Temperature Operation Life #2	$T_a=85^{\circ}\text{C}$ , $I_F=120\text{mA}$	1000hours
Low Temperature Storage	$T_a=-40^{\circ}\text{C}$	1000 hours
High Temperature/ Humidity Reverse Bias	$T_a=85^{\circ}\text{C}$ , $\text{RH}=85\%$	1000hours
High Temperature/ Humidity Operation Life	$T_a=85^{\circ}\text{C}$ , $\text{RH}=60\%$ , $I_F=120\text{mA}$	1000 hours
Temperature Cycle	H : $+100^{\circ}\text{C}$ 15min. ↓ 5min. 'L : $-40^{\circ}\text{C}$ 15min.	300 Cycles
Power Temperature Cycle	H : $+85^{\circ}\text{C}$ 15min. ↓ 5min. 'L : $-40^{\circ}\text{C}$ 15min.	1000 Cycles
Thermal Shock	H : $+110^{\circ}\text{C}$ 5min. ↓ 10sec. 'L : $-40^{\circ}\text{C}$ 5min.	300 Cycles
Pulse Test	$T_a=25^{\circ}\text{C}$ , $I_F=1000\text{mA}$ 30mS on/ 2500mS off	30000 times
ESD Human Body Model	2000V, Interval:0.5sec	3 times
ESD Machine Model	200V, Interval:0.5sec	3 times

\* $I_m$ : Brightness attenuate difference(1000hrs) $<50\%$

\* $V_f$ : Forward voltage difference $<20\%$

Notes: All reliability items are tested under superior thermal management with  $1.5 \times 1.5 \text{ cm}^2$  MCPCB.



**Precautions For Use****1. Over-current-proof**

Though EHP-A09 has conducted ESD protection mechanism, customers must not use the device in reverse and should apply resistors for extra protection. Otherwise, slight voltage difference may cause enormous current shift and burn out failure would happen.

**2. Storage**

- i. Do not open the moisture proof bag before the devices are ready to use.
- ii. Before the package is opened, LEDs should be stored at temperature less than 30°C and humidity less than 90%.
- iii. LEDs should be used within a year.
- iv. After the package is opened, LEDs should be stored at temperature less than 30°C and humidity less than 70%.
- v. LEDs should be used within 168 hours (7 days) after the package is opened.
- vi. If the moisture absorbent material (silicone gel) has faded away or LEDs have exceeded the storage time, baking treatment should be implemented based on the following the conditions: pre-curing at 60±5°C for 24 hours.

**3. Thermal Management**

- i. For maintaining the high flux output and achieving reliability, EHP-A09 series LEDs should be mounted on a metal core printed circuit board (MCPCB) or other kinds of heat sink with proper thermal connection to dissipate approximate 0.5W of thermal energy at 150mA operation.
- ii. Special thermal designs are also recommended to take in heat dissipation management, such as FR4 PCB on Aluminum with thermal vias or FPC on Aluminum with thermal conductive adhesive, etc.
- iii. Sufficient thermal management must be implemented. Otherwise, the junction temperature of dies might be over the limit at high current driving condition and LEDs' lifetime might be decreases dramatically.
- iv. For further thermal management suggestions, please consult Everlight Design Guide or local representatives for assistance.

#### 4. Soldering Condition

##### 4-1. For Reflow process

- i. EHP-A09 series are suitable for SMT process.
- ii. Lead reflow soldering temperature profile

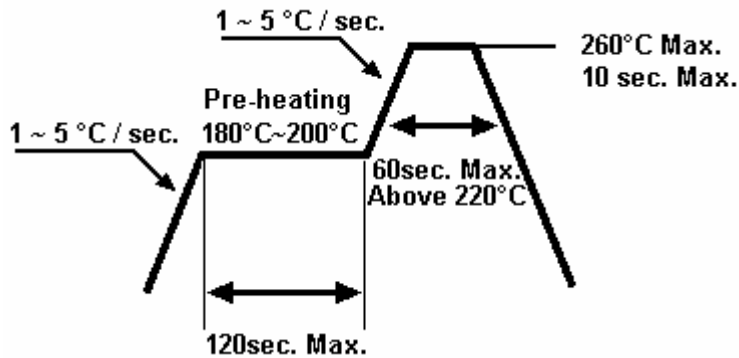

- iii. Reflow soldering should not be done more than two times.
- iv. In soldering process, stress on the LEDs during heating should be avoided.
- v. After soldering, do not warp the circuit board.