

V_{DRM}	= 1800	V	<h1>Phase Control Thyristor</h1> <h2>5STP 50Q1800</h2>
$I_{T(AV)M}$	= 6100	A	
$I_{T(RMS)}$	= 9600	A	
I_{TSM}	= 94×10^3	A	
$V_{(T0)}$	= 0.9	V	
r_T	= 0.05	m Ω	

Doc. No. 5SYA1070-01 Okt. 03

- Patented free-floating silicon technology
- Low on-state and switching losses
- Designed for traction, energy and industrial applications
- Optimum power handling capability
- Interdigitated amplifying gate

Blocking

Maximum rated values ¹⁾

Symbol	Conditions	5STP 50Q1800	--	--
V_{DRM}, V_{RRM}	$f = 50 \text{ Hz}, t_p = 10 \text{ ms}$	1800 V	--	--
V_{RSM}	$t_p = 5 \text{ ms}, \text{ single pulse}$	2000 V	--	--
dV/dt_{crit}	Exp. to $0.67 \times V_{DRM}, T_{vj} = 125^\circ\text{C}$	1000 V/ μs		

Characteristic values

Parameter	Symbol	Conditions	min	typ	max	Unit
Forward leakage current	I_{DRM}	$V_{DRM}, T_{vj} = 125^\circ\text{C}$			300	mA
Reverse leakage current	I_{RRM}	$V_{RRM}, T_{vj} = 125^\circ\text{C}$			300	mA

Mechanical data

Maximum rated values ¹⁾

Parameter	Symbol	Conditions	min	typ	max	Unit
Mounting force	F_M		81	90	108	kN
Acceleration	a	Device unclamped			50	m/s ²
Acceleration	a	Device clamped			100	m/s ²

Characteristic values

Parameter	Symbol	Conditions	min	typ	max	Unit
Weight	m				2.1	kg
Housing thickness	H	$F_M = 90 \text{ kN}, T_a = 25^\circ\text{C}$	25.5		26.5	mm
Surface creepage distance	D_S		36			mm
Air strike distance	D_a		15			mm

1) Maximum rated values indicate limits beyond which damage to the device may occur

ABB Switzerland Ltd, Semiconductors reserves the right to change specifications without notice.



On-state

Maximum rated values ¹⁾

Parameter	Symbol	Conditions	min	typ	max	Unit
Average on-state current	$I_{T(AV)M}$	Half sine wave, $T_c = 70^\circ\text{C}$			6100	A
RMS on-state current	$I_{T(RMS)}$				9600	A
Peak non-repetitive surge current	I_{TSM}	$t_p = 10\text{ ms}$, $T_{vj} = 125^\circ\text{C}$, $V_D = V_R = 0\text{ V}$			94×10^3	A
Limiting load integral	I^2t				41.28×10^6	A^2s
Peak non-repetitive surge current	I_{TSM}	$t_p = 8.3\text{ ms}$, $T_{vj} = 125^\circ\text{C}$, $V_D = V_R = 0\text{ V}$			100×10^3	A
Limiting load integral	I^2t				43.37×10^6	A^2s

Characteristic values

Parameter	Symbol	Conditions	min	typ	max	Unit
On-state voltage	V_T	$I_T = 3000\text{ A}$, $T_{vj} = 125^\circ\text{C}$			1.04	V
Threshold voltage	$V_{(T0)}$	$I_T = 4000\text{ A} - 18000\text{ A}$, $T_{vj} = 125^\circ\text{C}$			0.9	V
Slope resistance	r_T				0.05	$\text{m}\Omega$
Holding current	I_H	$T_{vj} = 25^\circ\text{C}$			100	mA
		$T_{vj} = 125^\circ\text{C}$			75	mA
Latching current	I_L	$T_{vj} = 25^\circ\text{C}$			500	mA
		$T_{vj} = 125^\circ\text{C}$			350	mA

Switching

Maximum rated values ¹⁾

Parameter	Symbol	Conditions	min	typ	max	Unit
Critical rate of rise of on-state current	di/dt_{crit}	$T_{vj} = 125^\circ\text{C}$, $I_{TRM} = 3000\text{ A}$, Cont. $f = 50\text{ Hz}$			250	$\text{A}/\mu\text{s}$
		$V_D \leq 0.67 V_{DRM}$, $I_{FG} = 2\text{ A}$, $t_r = 0.5\ \mu\text{s}$ Cont. $f = 1\text{ Hz}$			1000	$\text{A}/\mu\text{s}$
Circuit-commutated turn-off time	t_q	$T_{vj} = 125^\circ\text{C}$, $I_{TRM} = 3000\text{ A}$, $V_R = 200\text{ V}$, $di_T/dt = -20\text{ A}/\mu\text{s}$, $V_D \leq 0.67 \cdot V_{DRM}$, $dv_D/dt = 20\text{ V}/\mu\text{s}$	500			μs

Characteristic values

Parameter	Symbol	Conditions	min	typ	max	Unit
Recovery charge	Q_{rr}	$T_{vj} = 125^\circ\text{C}$, $I_{TRM} = 2000\text{ A}$, $V_R = 200\text{ V}$, $di_T/dt = -1.5\text{ A}/\mu\text{s}$			3000	μAs
Gate turn-on delay time	t_{gd}	$V_D = 0.4 \cdot V_{RM}$, $I_{FG} = 2\text{ A}$, $t_r = 0.5\ \mu\text{s}$, $T_{vj} = 25^\circ\text{C}$			3	μs

Triggering

Maximum rated values ¹⁾

Parameter	Symbol	Conditions	min	typ	max	Unit
Peak forward gate voltage	V _{FGM}				12	V
Peak forward gate current	I _{FGM}				10	A
Peak reverse gate voltage	V _{RGM}				10	V
Average gate power loss	P _{G(AV)}		see Fig. 9			

Characteristic values

Parameter	Symbol	Conditions	min	typ	max	Unit
Gate-trigger voltage	V _{GT}	T _{vj} = 25 °C			2.6	V
Gate-trigger current	I _{GT}	T _{vj} = 25 °C			400	mA
Gate non-trigger voltage	V _{GD}	V _D = 0.4 x V _{DRM} , T _{vj} = 125 °C	0.3			V
Gate non-trigger current	I _{GD}	V _D = 0.4 x V _{DRM} , T _{vj} = 125 °C	10			mA

Thermal

Maximum rated values ¹⁾

Parameter	Symbol	Conditions	min	typ	max	Unit
Operating junction temperature range	T _{vj}				125	°C
Storage temperature range	T _{stg}		-40		140	°C

Characteristic values

Parameter	Symbol	Conditions	min	typ	max	Unit
Thermal resistance junction to case	R _{th(j-c)}	Double-side cooled			5	K/kW
	R _{th(j-c)A}	Anode-side cooled			10	K/kW
	R _{th(j-c)C}	Cathode-side cooled			10	K/kW
Thermal resistance case to heatsink	R _{th(c-h)}	Double-side cooled			1	K/kW
	R _{th(c-h)}	Single-side cooled			2	K/kW

Analytical function for transient thermal impedance:

$$Z_{th(j-c)}(t) = \sum_{i=1}^n R_i(1 - e^{-t/\tau_i})$$

i	1	2	3	4
R _i (K/kW)	3.359	0.936	0.481	0.224
τ _i (s)	0.4069	0.0854	0.0118	0.0030

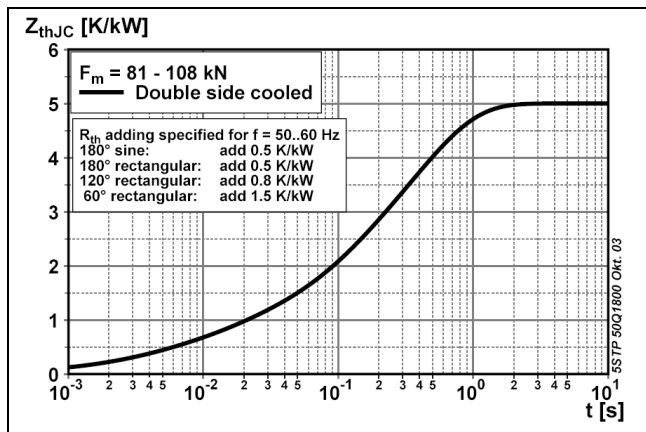

Fig. 1 Transient thermal impedance junction-to case.

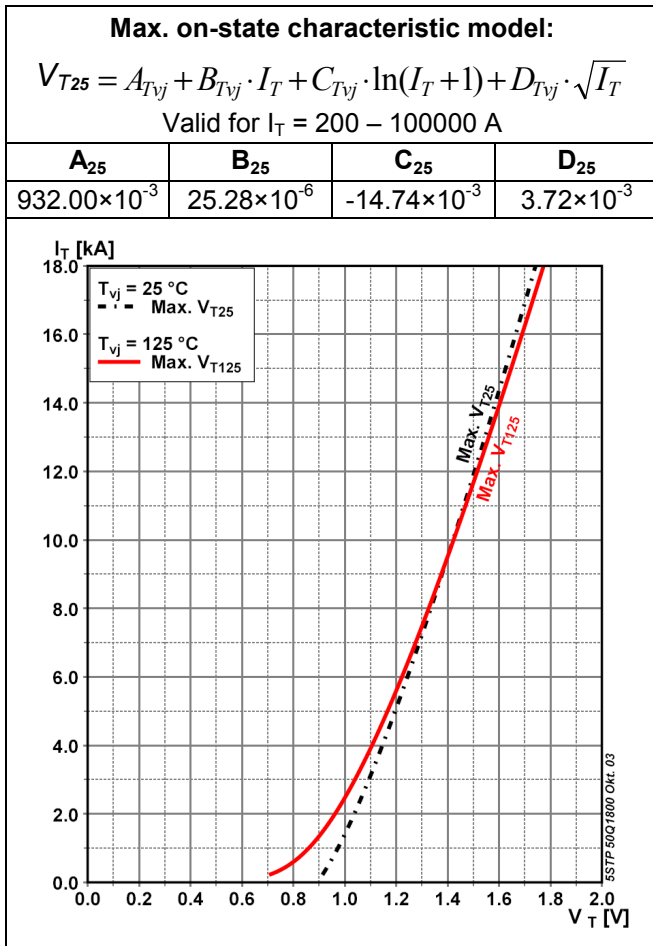

Fig. 2 On-state characteristics.
 $T_j = 125^\circ\text{C}$, 10ms half sine

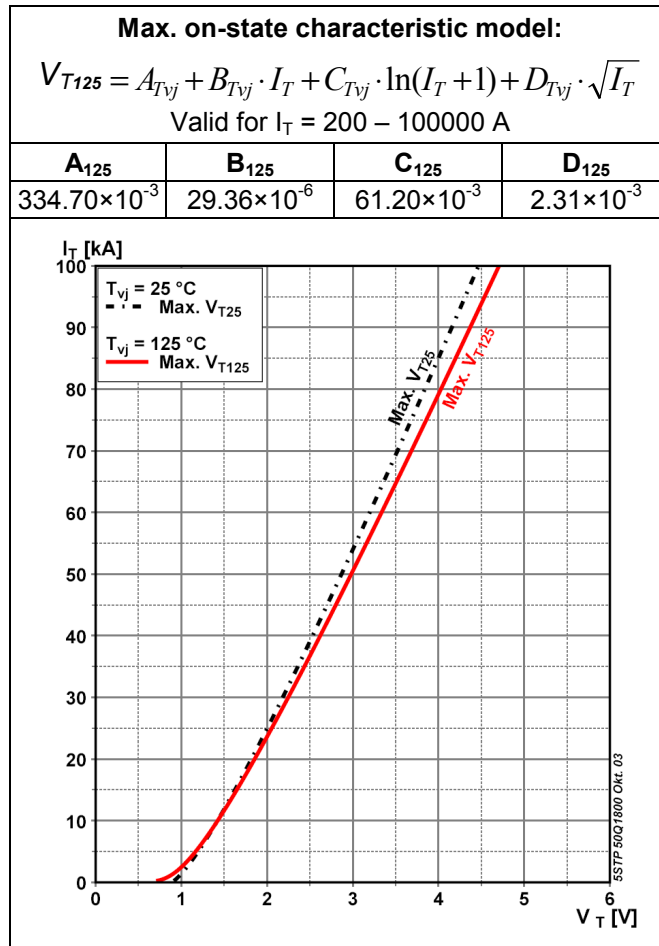

Fig. 3 Max. on-state voltage characteristics

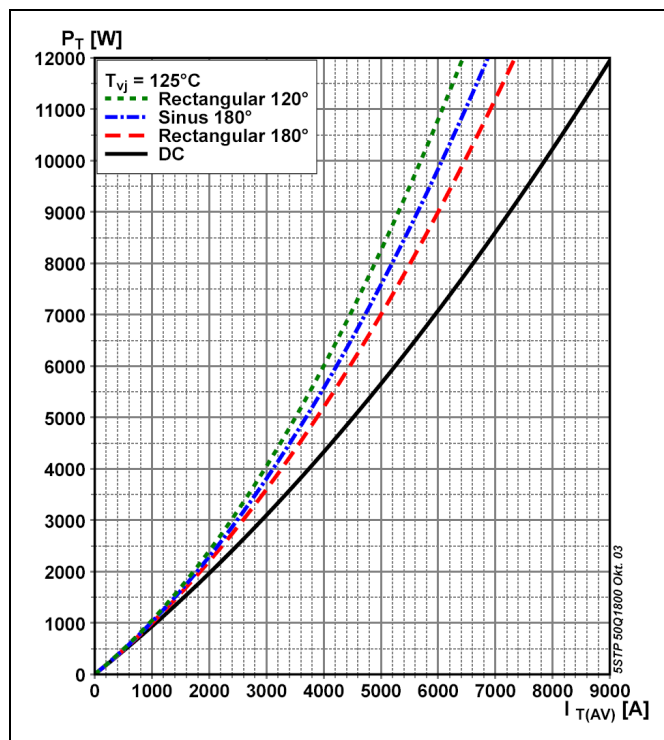

Fig. 4 On-state power dissipation vs. mean on-state current. Turn - on losses excluded.

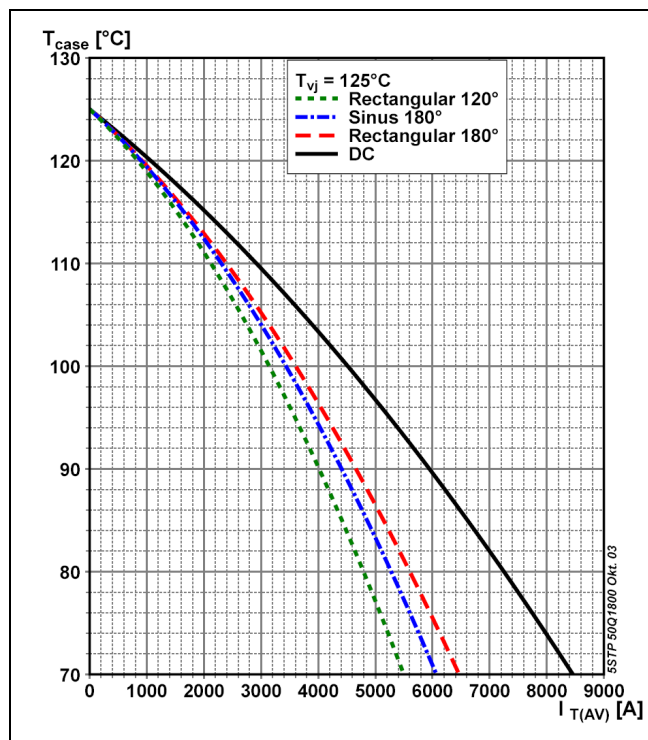

Fig. 5 Max. permissible case temperature vs. mean on-state current.

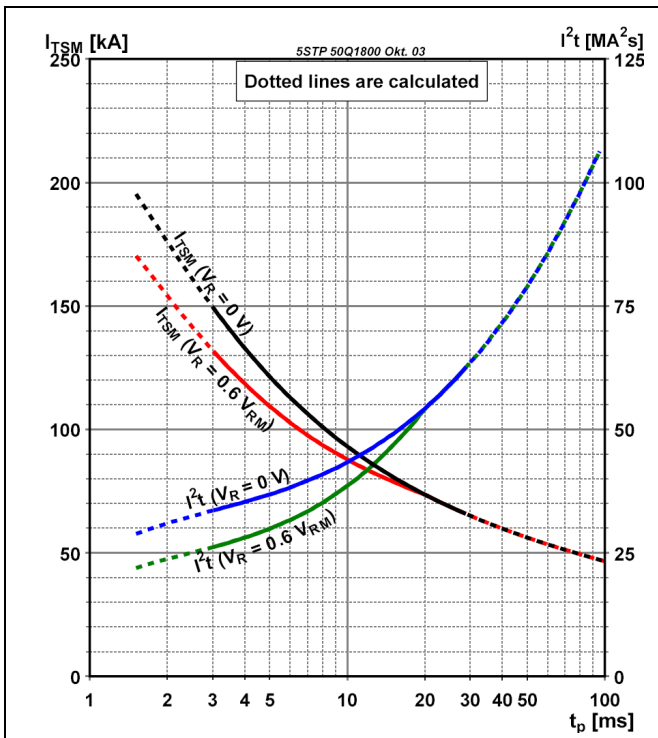

Fig. 6 Surge on-state current vs. pulse length. Half-sine wave.

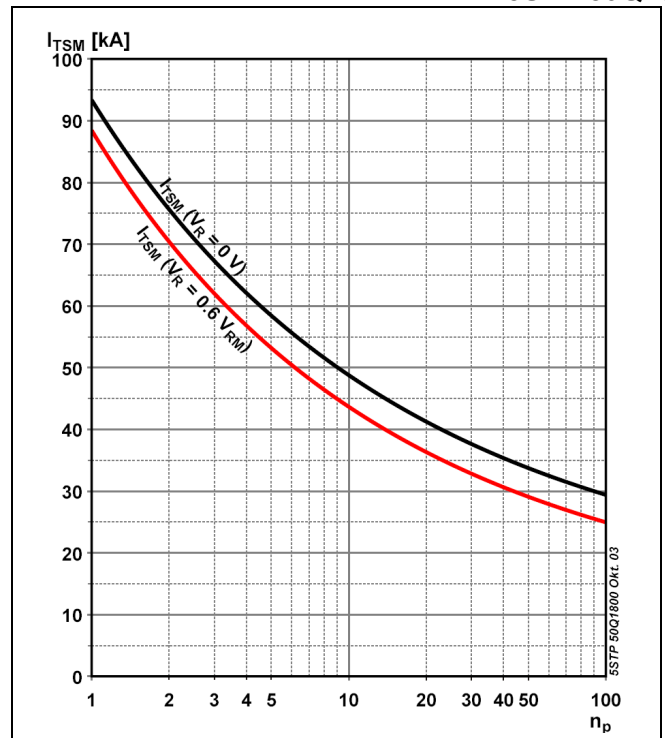

Fig. 7 Surge on-state current vs. number of pulses. Half-sine wave, 10 ms, 50Hz.

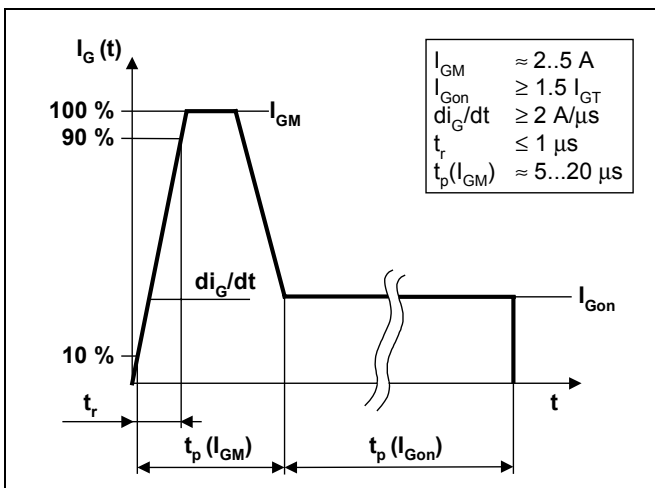

Fig. 8 Recommended gate current waveform.

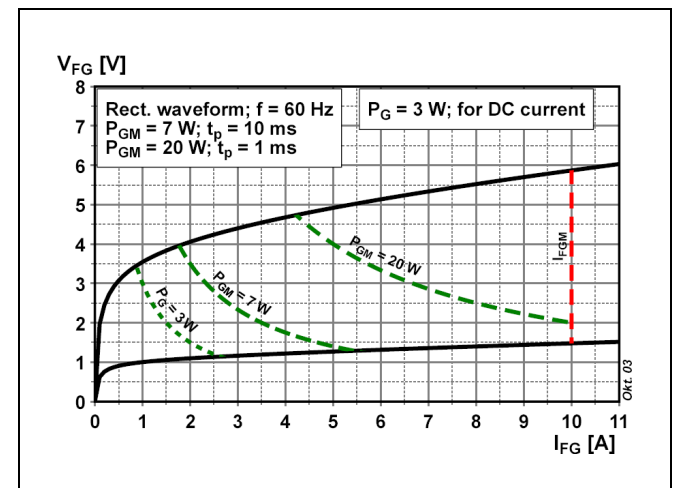

Fig. 9 Max. peak gate power loss.

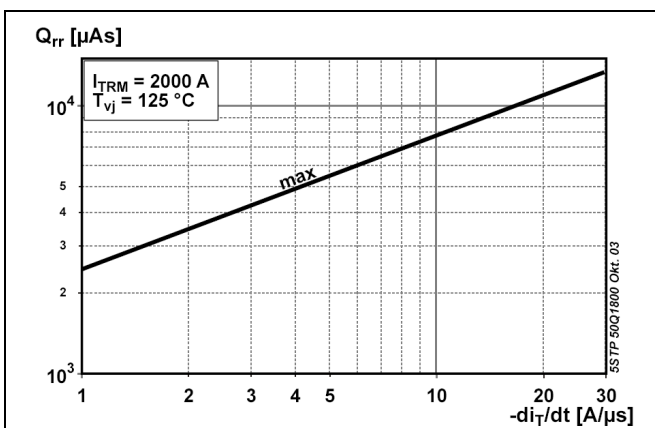

Fig. 10 Recovery charge vs. decay rate of on-state current.

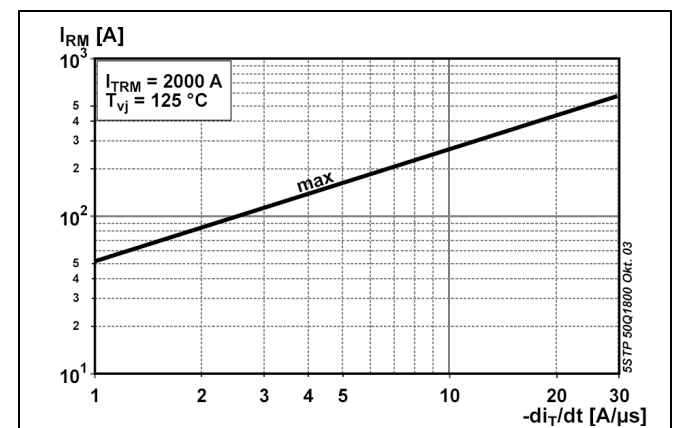

Fig. 11 Peak reverse recovery current vs. decay rate of on-state current.

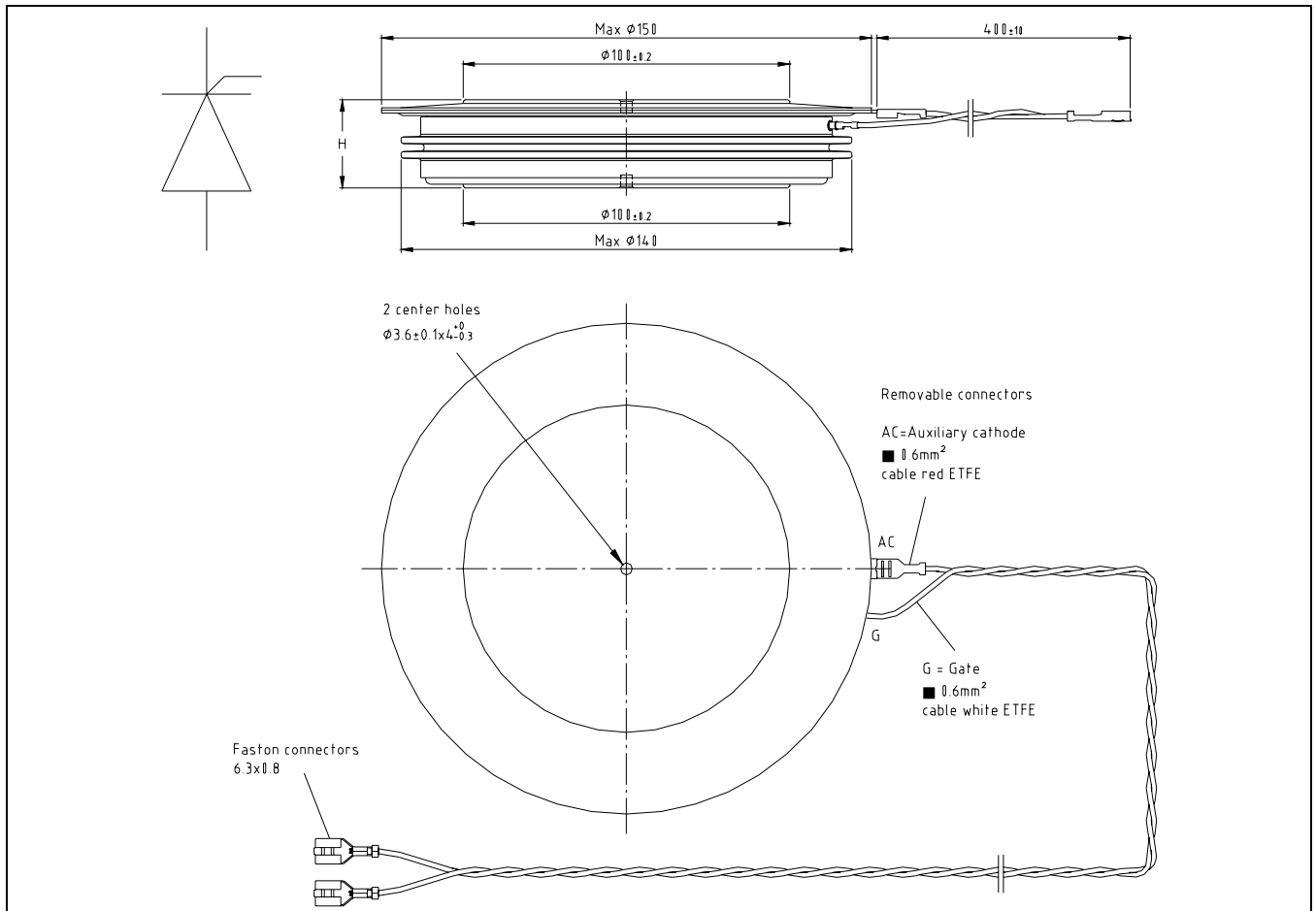

Fig. 12 Device Outline Drawing.

ABB Switzerland Ltd, Semiconductors reserves the right to change specifications without notice.

ABB

ABB Switzerland Ltd
 Semiconductors
 Fabrikstrasse 3
 CH-5600 Lenzburg, Switzerland

Doc. No. 5SYA1070-01 Okt. 03

Telephone +41 (0)58 586 1419
 Fax +41 (0)58 586 1306
 Email abbsem@ch.abb.com
 Internet www.abb.com/semiconductors