

3.3-3.8 GHz HFET 3W Linear Power Amplifier

Features

- X P1dB, 3W
- X Power Gain, 13 dB
- X Positive Voltage Supply, +5V to +8V
- X Output and Input Pre-Matched Internally
- X Thermally Efficient for Higher MTTF
- X RoHS Compliant 6X6mm QFN
- X Ideal for WiMAX Applications (802.16)

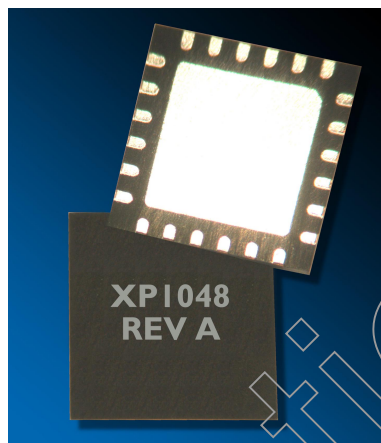

General Description

The XP1048-QJ is a high linearity single stage power amplifier capable of 13 dB of gain, 3 Watt of power at 1 dB compression and is housed in a 6X6mm QFN package.

The XP1048-QJ provides less than 2.5% EVM at 27 dBm output power with 802.16 OFDM signal and peak to average power ratio of 9.17 dB. The input and output of the device are pre-matched facilitating a simplified output matching approach. The quiescent current is controlled using a negative voltage.

The high dynamic range of this device makes it ideal as a final or driver stage for WiMAX equipment in the 3.3-3.8 GHz bands.

Absolute Maximum Ratings

Voltage Supply (Vdd)	9V
Current (Idd)	1000 mA
Dissipated Power (P _{diss})	8W
Input Power (P _{in})	25 dBm
Storage Temperature (T _{stg})	-60 to +150 °C
Channel Temperature (T _{ch})	200 °C
Thermal Resistance (R _{th})	20 °C/W
Operating Backside Temperature (T _b)	-40 °C to (see note 1)

Operation outside any of these limits can cause permanent damage.
(1) Calculate maximum operating temperature T_{max} using the following formula: T_{max}=200-(P_{diss} [W] x 20) [C].

Electrical Characteristics (Ambient Temperature T=25 °C, V_{cc}=8V)¹

Description	Parameter	Units	Min.	Typ.	Max.
Operating Frequency	f	GHz	3.3	3.5	3.8
Quiescent Current ⁽²⁾	I _{dq}	mA	-	600	-
Power Gain @ P _{out} = 27dBm	G _{ps}	dB	-	13	-
Output Power @ EVM = 2.5% ⁽³⁾	P _{out}	dBm	-	27	-
Adjacent Channel Power Ratio @P _{out} = 27dBm ⁽⁴⁾	ACPR	dBc	-	-45	-
Power @ 1dB Compression Point	P1dB	dBm	-	34.5	-
Output Third order intercept Point @ 27dBm/tone ⁽⁵⁾	OIP3	dBm	-	46	-
Gate Voltage	V _{gg}	V	-	-0.8	-
Noise Figure	NF	dB	-	5	-

- (1) Data measured in a Mimix matched connectorized fixture.
 (2) Quiescent current depends on V_{gg}
 (3) Using an 802.16d OFDM signal format with PAR = 9dB
 (4) Using 3 GPP WCDMA signal, PAR = 9.17dB
 (5) 100KHz spacing

3.3-3.8 GHz HFET 3W Linear Power Amplifier

December 2007 - Rev 03-Dec-07

PI048-QJ
RoHS

Typical Performance

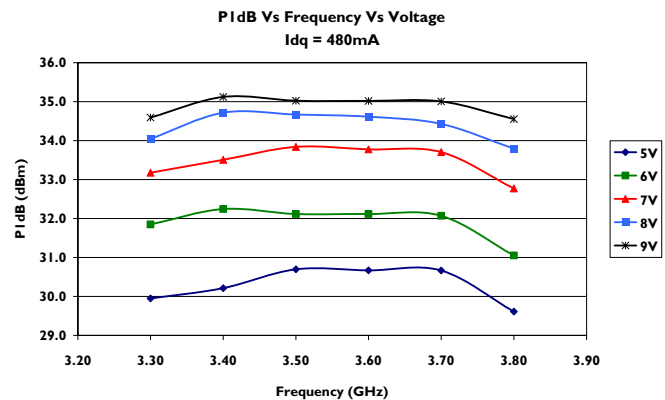
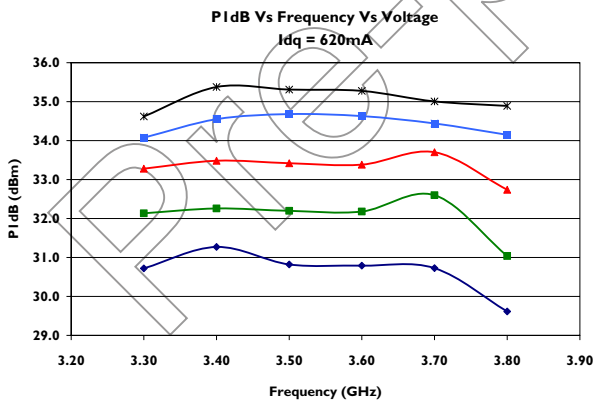
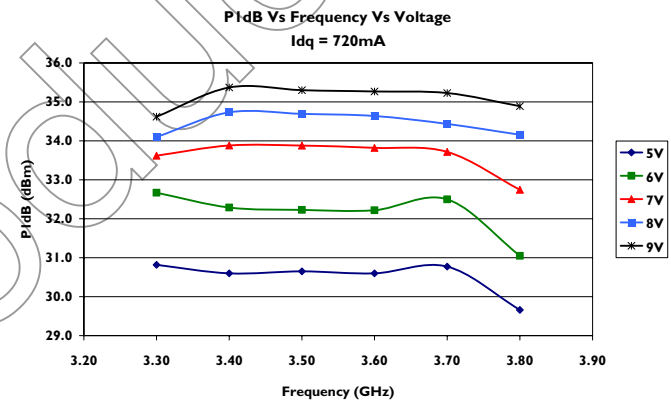
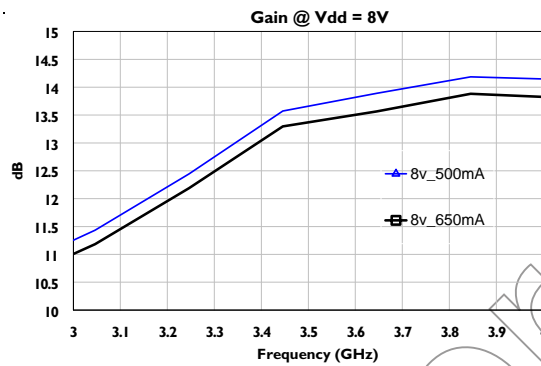
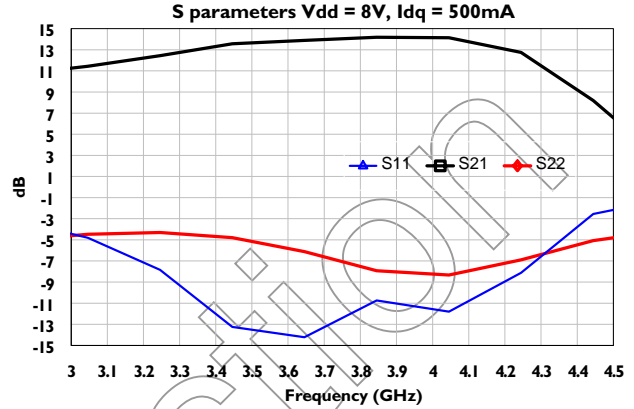
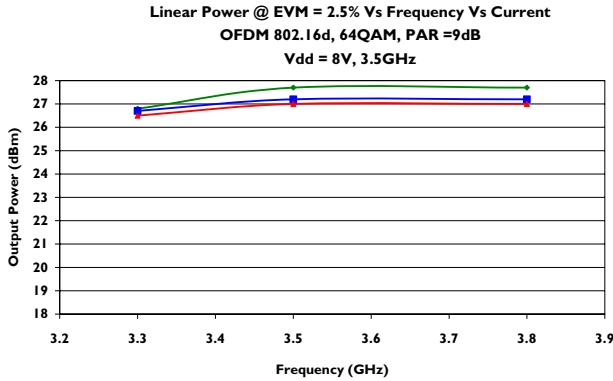

3.3-3.8 GHz HFET 3W Linear Power Amplifier

December 2007 - Rev 03-Dec-07

PI048-QJ
RoHS

Typical Performance (cont.)

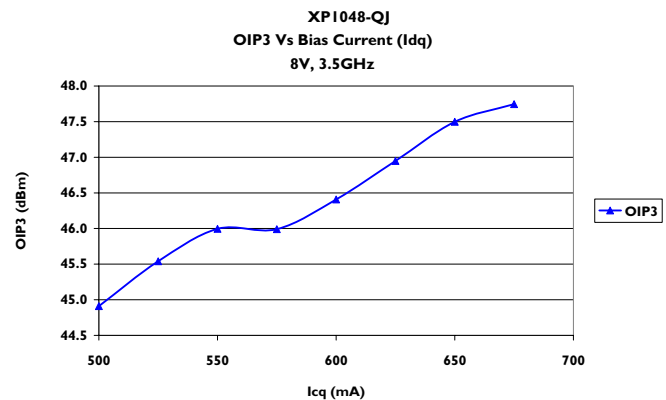
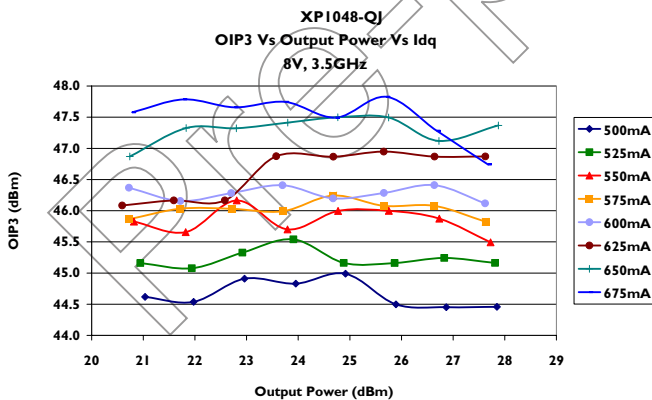
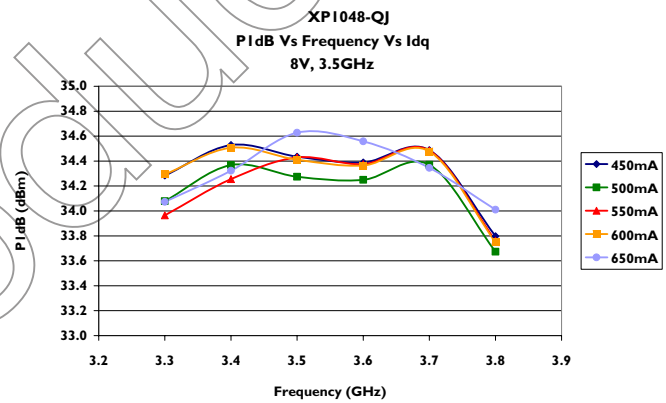
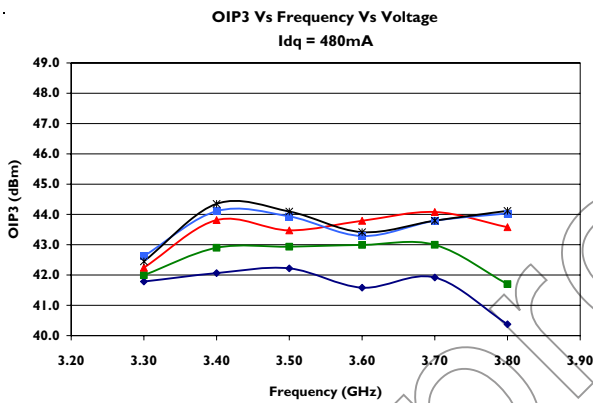
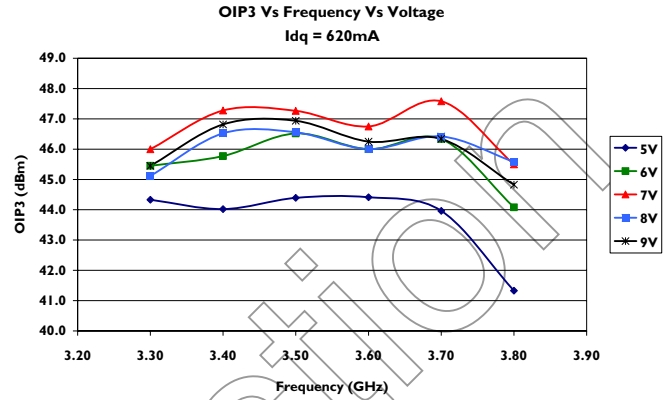
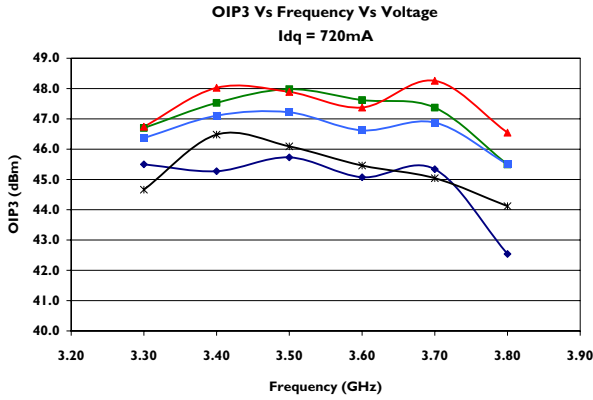

3.3-3.8 GHz HFET 3W Linear Power Amplifier

Typical Performance (cont.)

Linear Power @ EVM = 2.5%, 3.5GHz
OFDM 802.16d, 64QAM, PAR =9dB
Vdd = 8V, 3.5GHz

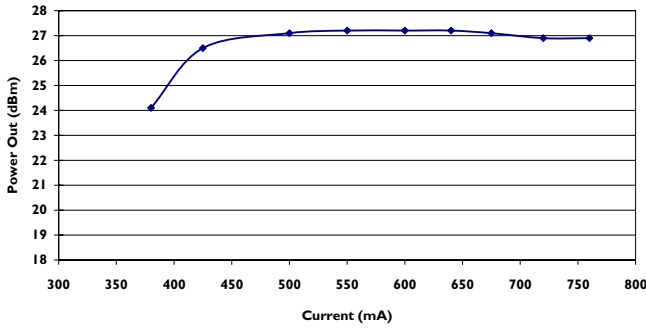

Output Power, Current Vs Input Power
Vdd 8V, 3.5GHz

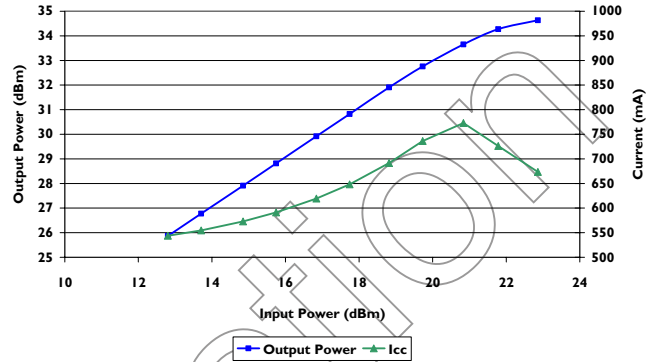

Output Power, Gain Vs Input Power
8V, 3.5GHz

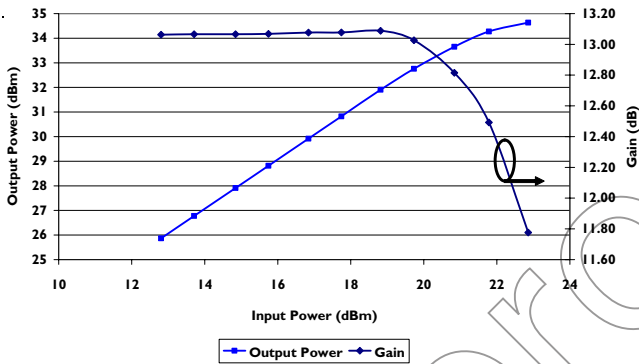

OIP3, Icc, Gain Vs Output Power
Vdd = 8V, Idq = 550mA @ 3.5GHz

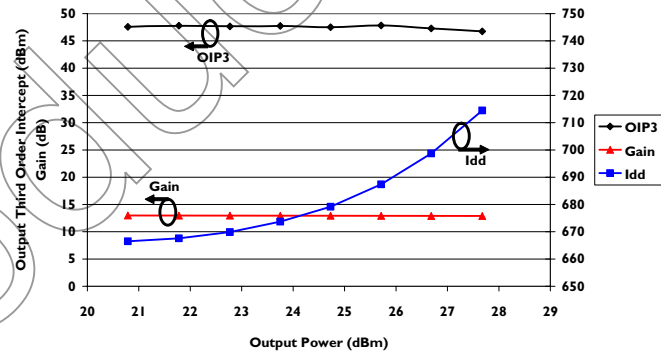

Gamma Opt Output

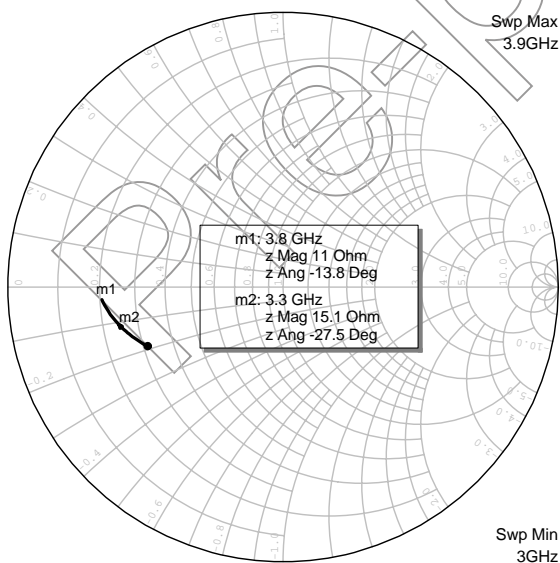

3.3-3.8 GHz HFET 3W Linear Power Amplifier

Recommended Schematic

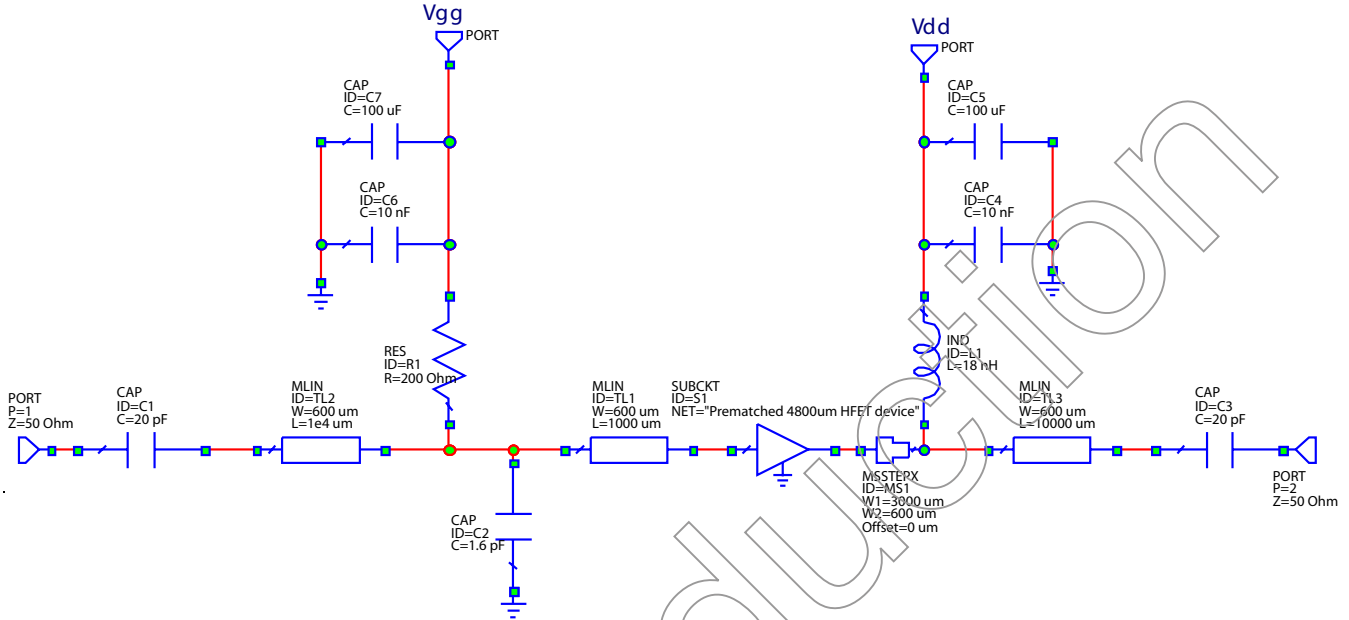

Evaluation Board Layout

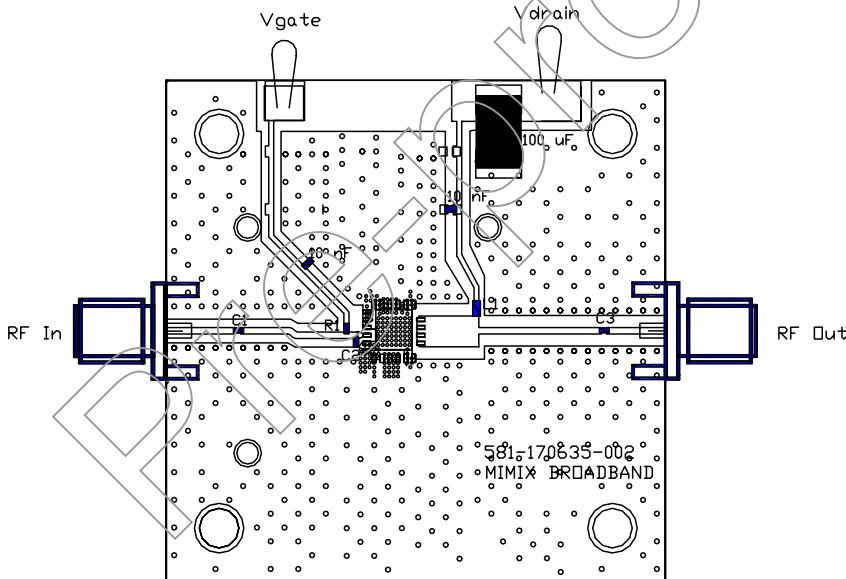

Component	Value
C1	20pf HiQ 0402 Murata
C2	1.6pf HiQ 0402 Murata
C3	20pf HiQ 0603 Murata
R1	0ohm link
R2	200ohm resistor
L1	18nH 0603 Wirewound Murata

3.3-3.8 GHz HFET 3W Linear Power Amplifier

December 2007 - Rev 03-Dec-07

PI048-QJ
RoHS

App Note [1] Biasing - The XP1044-QL requires power supply sequencing. Negative voltage supply (V_{gg}) needs to be turned on first and then positive voltage can be applied to the drain (V_{dd}). When turning off the device, the positive supply (V_{dd}) should be turned off first and then negative voltage (V_{gg}) can be removed.

The gate voltage is adjusted in order to set the drain current to the desired level. The gate voltage required to achieve a certain current can vary over temperature and from one device to another due to pinch-off voltage variation. Constant drain current can be achieved by implementing an active bias circuit which allows for temperature compensation and eliminates the effect of pinch-off voltage variation. Typical cost of such applications is \$0.15.

Physical Dimensions:

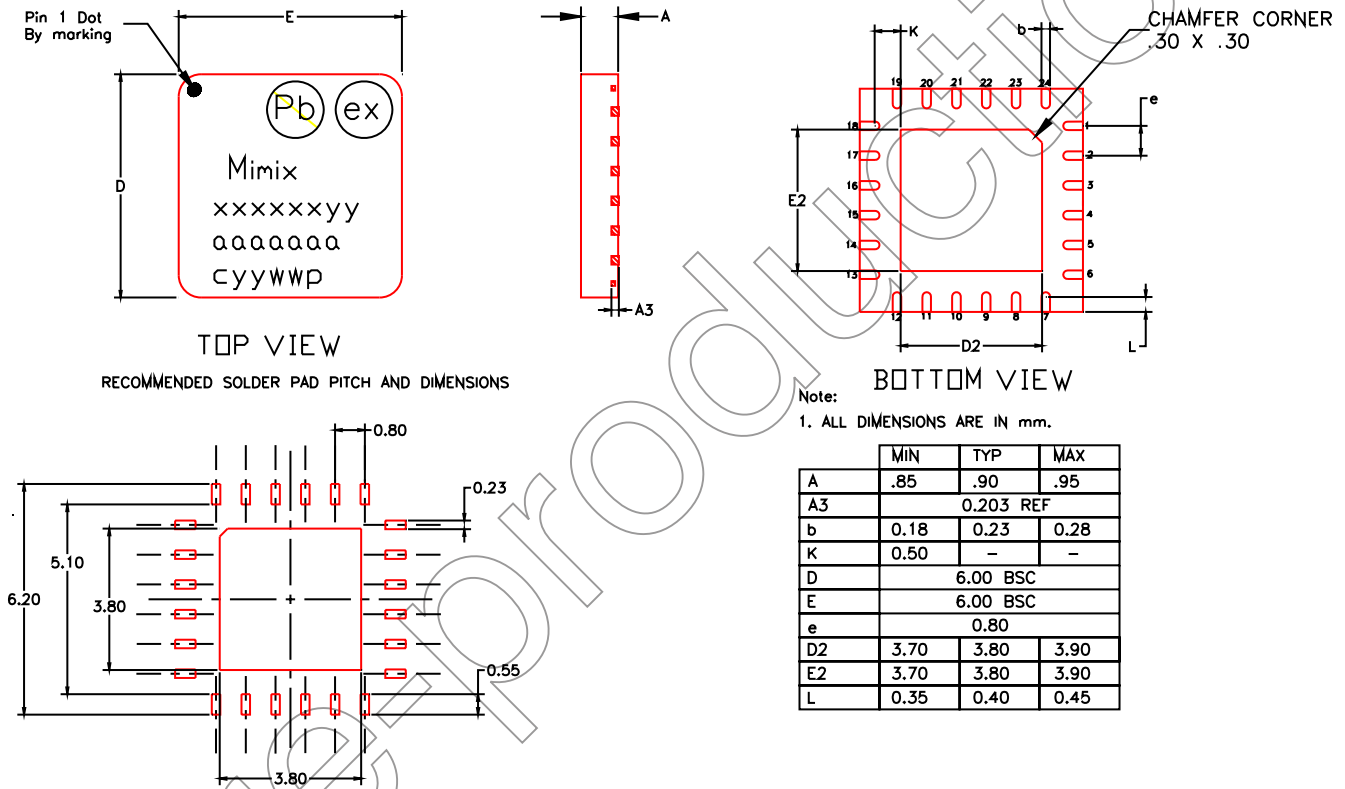

3.3-3.8 GHz HFET 3W Linear Power Amplifier

December 2007 - Rev 03-Dec-07

PI048-QJ
RoHS

Pin Assignment:

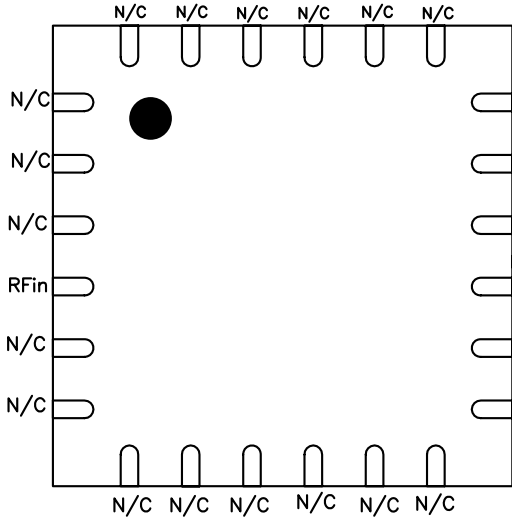

TOP VIEW

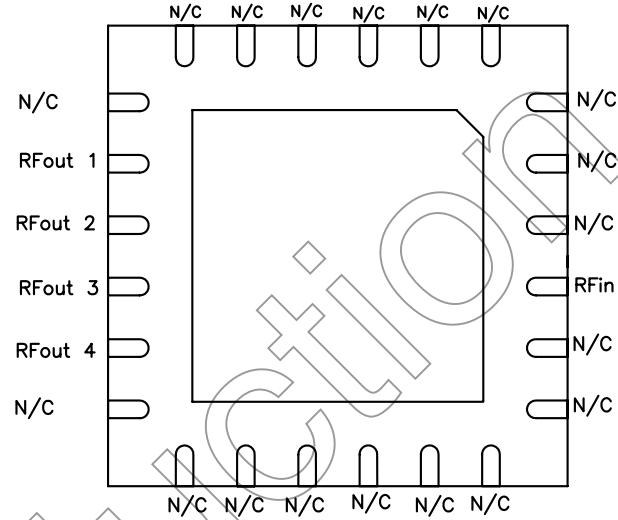

BOTTOM VIEW

Functional Block Diagram:

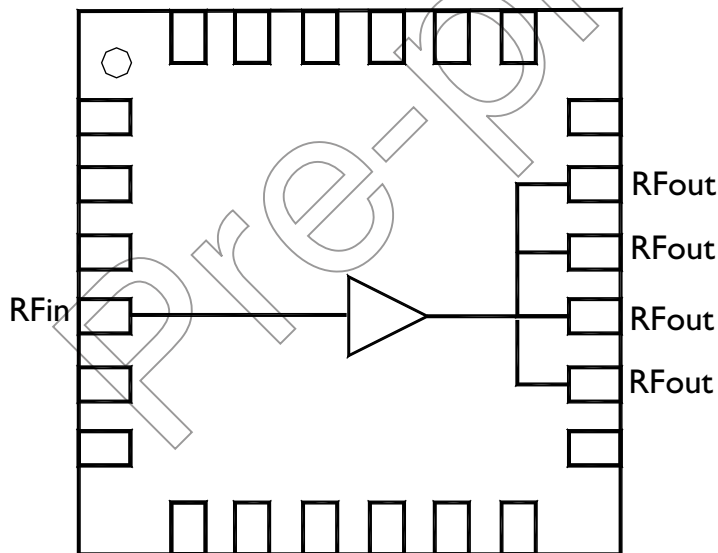

Pin #	Description
4	RF IN
14	RF OUT 4
15	RF OUT 3
16	RF OUT 2
17	RF OUT 1
2, 3, 5, 6, 7, 8, 9, 10, 11, 12 13, 18, 19, 20, 21, 22, 23, 24	N/C

3.3-3.8 GHz HFET 3W Linear Power Amplifier

December 2007 - Rev 03-Dec-07

Handling and Assembly Information

CAUTION! - Mimix Broadband MMIC Products contain gallium arsenide (GaAs) which can be hazardous to the human body and the environment. For safety, observe the following procedures:

- Do not ingest.
- Do not alter the form of this product into a gas, powder, or liquid through burning, crushing, or chemical processing as these by-products are dangerous to the human body if inhaled, ingested, or swallowed.
- Observe government laws and company regulations when discarding this product. This product must be discarded in accordance with methods specified by applicable hazardous waste procedures.

Life Support Policy - Mimix Broadband's products are not authorized for use as critical components in life support devices or systems without the express written approval of the President and General Counsel of Mimix Broadband. As used herein: (1) Life support devices or systems are devices or systems which, (a) are intended for surgical implant into the body, or (b) support or sustain life, and whose failure to perform when properly used in accordance with instructions for use provided in the labeling, can be reasonably expected to result in a significant injury to the user. (2) A critical component is any component of a life support device or system whose failure to perform can be reasonably expected to cause the failure of the life support device or system, or to affect its safety or effectiveness.

Package Attachment - This packaged product from Mimix Broadband is provided as a rugged surface mount package compatible with high volume solder installation. Care should be taken not to apply heavy pressure to the top or base material to avoid package damage. Vacuum tools or other suitable pick and place equipment may be used to pick and place this part. Care should be taken to ensure that there are no voids or gaps in the solder connection so that good RF, DC and ground connections are maintained. Voids or gaps can eventually lead not only to RF performance degradation, but reduced reliability and life of the product due to thermal stress.

Mimix Lead-Free RoHS Compliant Program - Mimix has an active program in place to meet customer and governmental requirements for eliminating lead (Pb) and other environmentally hazardous materials from our products. All Mimix RoHS compliant components are form, fit and functional replacements for their non-RoHS equivalents. Lead plating of our RoHS compliant parts is 100% matte tin (Sn) over copper alloy and is backwards compatible with current standard SnPb low-temperature reflow processes as well as higher temperature (260°C reflow) "Pb Free" processes.

Ordering Information

Part Number	Description
XP1048-QJ-0G00	Matte Tin plated RoHS compliant 6X6 QFN surface mount package in bulk
XP1048-QJ-0G0T	Matte Tin Plated RoHS compliant 6X6 QFN surface mount package in tape and reel
XP1048-QJ-EV1	Evaluation Board with SMA connectors for WiMAX 3.5 GHz

We also offer the plastic package with SnPb (Tin-Lead) or NiPdAu plating. Please contact your regional sales manager for more information regarding different plating types.