

# TC4SU11F

## 2 INPUT NAND GATE

TC4SU11F is 2 input NAND gate respectively.  
 The internal circuit of only basic NAND circuit without the waveform shaping inverter.  
 Therefore, this is suitable for the applications in liner circuits such as oscillator circuits and amplifier circuits, and this has advantage in the applications of Logical processing systems with faster operating speed.

### MAXIMUM RATINGS

CHARACTERISTIC	SYMBOL	RATING	UNIT
DC Supply Voltage	V <sub>DD</sub>	V <sub>SS</sub> - 0.5~V <sub>SS</sub> + 20	V
Input Voltage	V <sub>IN</sub>	V <sub>SS</sub> - 0.5~V <sub>DD</sub> + 0.5	V
Output Voltage	V <sub>OUT</sub>	V <sub>SS</sub> - 0.5~V <sub>DD</sub> + 0.5	V
DC Input Current	I <sub>IN</sub>	± 10	mA
Power Dissipation	P <sub>D</sub>	200	mW
Operating Temperature Range	T <sub>opr</sub>	- 40~85	°C
Storage Temperature Range	T <sub>stg</sub>	- 65~150	°C
Lead Temperature (10s)	T <sub>L</sub>	260	°C

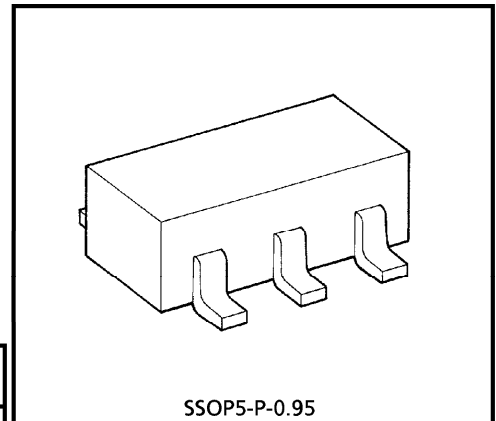

Weight : 0.016g (Typ.)

### Marking

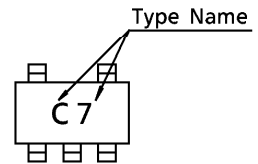

### LOGIC DIAGRAM

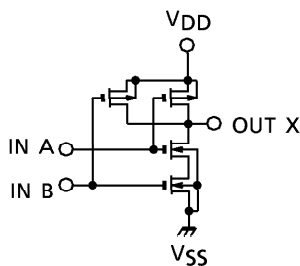

### PIN ASSIGNMENT (TOP VIEW)

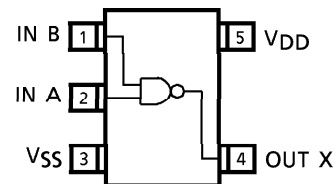

**RECOMMENDED OPERATING CONDITIONS (V<sub>SS</sub> = 0V)**

CHARACTERISTIC	SYMBOL	MIN.	TYP.	MAX.	UNIT	
DC Supply Voltage	V <sub>DD</sub>	—	3	—	18	V
Input Voltage	V <sub>IN</sub>	—	0	—	V <sub>DD</sub>	V

**STATIC ELECTRICAL CHARACTERISTICS (V<sub>SS</sub> = 0V)**

CHARACTERISTIC	SYM-BOL	TEST CONDITION	V <sub>DD</sub> (V)	- 40°C		25°C			85°C		UNIT	
				MIN.	MAX.	MIN.	TYP.	MAX.	MIN.	MAX.		
High-Level Output Voltage	V <sub>OH</sub>	I <sub>OUT</sub>   < 1μA V <sub>IN</sub> = V <sub>SS</sub>	5	4.95	—	4.95	5.00	—	4.95	—	V	
			10	9.95	—	9.95	10.00	—	9.95	—		
			15	14.95	—	14.95	15.00	—	14.95	—		
Low-Level Output Voltage	V <sub>OL</sub>	I <sub>OUT</sub>   < 1μA V <sub>IN</sub> = V <sub>DD</sub>	5	—	0.05	—	0.00	0.05	—	0.05	V	
			10	—	0.05	—	0.00	0.05	—	0.05		
			15	—	0.05	—	0.00	0.05	—	0.05		
Output High Current	I <sub>OH</sub>	V <sub>OH</sub> = 4.6V V <sub>OH</sub> = 2.5V V <sub>OH</sub> = 9.5V V <sub>OH</sub> = 13.5V V <sub>IN</sub> = V <sub>SS</sub> , V <sub>DD</sub>	5	-0.61	—	-0.51	-1.0	—	-0.42	—	mA	
			5	-2.5	—	-2.1	-4.0	—	-1.7	—		
			10	-1.5	—	-1.3	-2.2	—	-1.1	—		
			15	-4.0	—	-3.4	-9.0	—	-2.8	—		
Output Low Current	I <sub>OL</sub>	V <sub>OL</sub> = 0.4V V <sub>OL</sub> = 0.5V V <sub>OL</sub> = 1.5V V <sub>IN</sub> = V <sub>DD</sub>	5	0.61	—	0.51	1.2	—	0.42	—	mA	
			10	1.5	—	1.3	3.2	—	1.1	—		
			15	4.0	—	3.4	12.0	—	2.8	—		
			5	4.0	—	4.0	3.0	—	4.0	—		
Input High Voltage	V <sub>IH</sub>	V <sub>OUT</sub> = 0.5V V <sub>OUT</sub> = 1.0V V <sub>OUT</sub> = 1.5V  I <sub>OUT</sub>   < 1μA	10	8.0	—	8.0	6.5	—	8.0	—	V	
			15	12.0	—	12.0	9.5	—	12.0	—		
			5	—	1.0	—	2.0	1.0	—	1.0		—
Input Low Voltage	V <sub>IL</sub>	V <sub>OUT</sub> = 4.5V V <sub>OUT</sub> = 9.0V V <sub>OUT</sub> = 13.5V  I <sub>OUT</sub>   < 1μA	10	—	2.0	—	3.5	2.0	—	2.0	V	
			15	—	3.0	—	5.5	3.0	—	3.0		
			5	—	—	—	—	—	—	—		—
Input Current	H Level	I <sub>IH</sub>	V <sub>IH</sub> = 18V	18	—	0.1	—	10 <sup>-5</sup>	0.1	—	1.0	μA
	L Level	I <sub>IL</sub>	V <sub>IL</sub> = 0V	18	—	-0.1	—	-10 <sup>-5</sup>	-0.1	—	-1.0	
Quiescent Device Current	I <sub>DD</sub>	V <sub>IN</sub> = V <sub>SS</sub> , V <sub>DD</sub>	5	—	0.25	—	0.001	0.25	—	7.5	μA	
			10	—	0.5	—	0.001	0.5	—	15		
			15	—	1.0	—	0.002	1.0	—	30		

**DYNAMIC ELECTRICAL CHARACTERISTICS** ( $T_a = 25^\circ\text{C}$ ,  $V_{SS} = 0\text{V}$ ,  $C_L = 50\text{pF}$ )

CHARACTERISTIC	SYMBOL	TEST CONDITION	V <sub>DD</sub> (V)	MIN.	TYP.	MAX.	UNIT
Output Transition Time (Low to High)	t <sub>TLH</sub>	—	5	—	70	200	ns
			10	—	35	100	
			15	—	30	80	
Output Transition Time (High to Low)	t <sub>THL</sub>	—	5	—	60	200	ns
			10	—	25	100	
			15	—	20	80	
Propagation Delay Time	t <sub>pLH</sub>	—	5	—	50	110	ns
			10	—	28	60	
			15	—	22	50	
Propagation Delay Time	t <sub>pHL</sub>	—	5	—	50	110	ns
			10	—	28	60	
			15	—	22	50	
Input Capacitance	C <sub>IN</sub>	—	—	5	7.5	pF	

**CIRCUIT AND WAVEFORM FOR MEASUREMENT OF DYNAMIC CHARACTERISTICS**

CIRCUIT

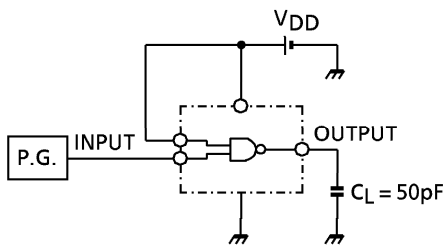

WAVEFORM

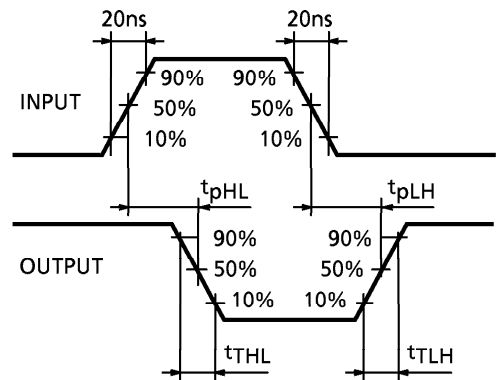

PACKAGE DIMENSIONS  
SSOP5-P-0.95

Unit : mm

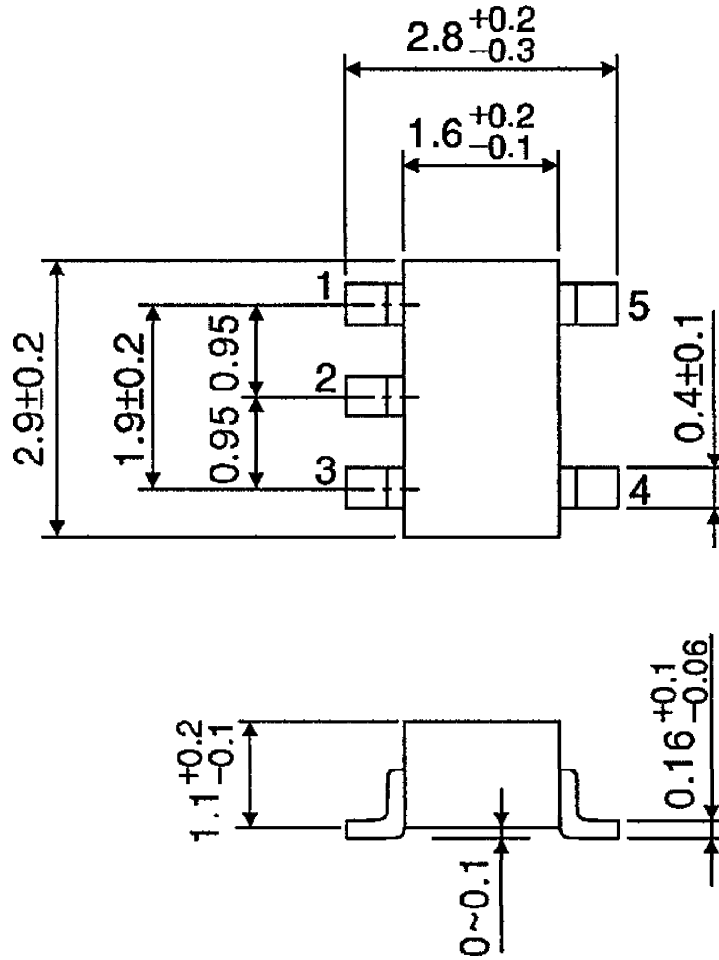

Weight : 0.016g (Typ.)

**RESTRICTIONS ON PRODUCT USE**

000707EBA

- TOSHIBA is continually working to improve the quality and reliability of its products. Nevertheless, semiconductor devices in general can malfunction or fail due to their inherent electrical sensitivity and vulnerability to physical stress. It is the responsibility of the buyer, when utilizing TOSHIBA products, to comply with the standards of safety in making a safe design for the entire system, and to avoid situations in which a malfunction or failure of such TOSHIBA products could cause loss of human life, bodily injury or damage to property. In developing your designs, please ensure that TOSHIBA products are used within specified operating ranges as set forth in the most recent TOSHIBA products specifications. Also, please keep in mind the precautions and conditions set forth in the "Handling Guide for Semiconductor Devices," or "TOSHIBA Semiconductor Reliability Handbook" etc..
- The TOSHIBA products listed in this document are intended for usage in general electronics applications (computer, personal equipment, office equipment, measuring equipment, industrial robotics, domestic appliances, etc.). These TOSHIBA products are neither intended nor warranted for usage in equipment that requires extraordinarily high quality and/or reliability or a malfunction or failure of which may cause loss of human life or bodily injury ("Unintended Usage"). Unintended Usage include atomic energy control instruments, airplane or spaceship instruments, transportation instruments, traffic signal instruments, combustion control instruments, medical instruments, all types of safety devices, etc.. Unintended Usage of TOSHIBA products listed in this document shall be made at the customer's own risk.
- The products described in this document are subject to the foreign exchange and foreign trade laws.
- The information contained herein is presented only as a guide for the applications of our products. No responsibility is assumed by TOSHIBA CORPORATION for any infringements of intellectual property or other rights of the third parties which may result from its use. No license is granted by implication or otherwise under any intellectual property or other rights of TOSHIBA CORPORATION or others.
- The information contained herein is subject to change without notice.