

**SEMİTOP® 2**

## IGBT Module

**SK20GB123**

Preliminary Data

### Features

- Compact design
- One screw mounting
- Heat transfer and isolation through direct copper bonded aluminium oxide ceramic (DCB)
- N-channel homogeneous silicon structure (NPT-Non punch-through IGBT)
- High short circuit capability
- Low tail current with low temperature dependence

### Typical Applications

- Switching (not for linear use)
- Inverter
- Switched mode power supplies
- UPS

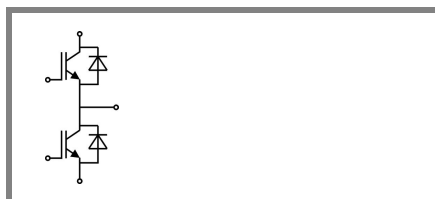

**GB**

Absolute Maximum Ratings		$T_s = 25\text{ °C}$ , unless otherwise specified			
Symbol	Conditions	Values			Units
<b>IGBT</b>					
$V_{CES}$	$T_j = 25\text{ °C}$	1200			V
$I_C$	$T_j = 125\text{ °C}$	$T_s = 25\text{ °C}$	23		A
		$T_s = 80\text{ °C}$	15		A
$I_{CRM}$	$I_{CRM} = 2 \times I_{Cnom}$	30			A
$V_{GES}$		$\pm 20$			V
$t_{psc}$	$V_{CC} = 600\text{ V}; V_{GE} \leq 20\text{ V}; T_j = 125\text{ °C}$ $V_{CES} < 1200\text{ V}$	10			$\mu\text{s}$
<b>Inverse Diode</b>					
$I_F$	$T_j = 150\text{ °C}$	$T_s = 25\text{ °C}$	24		A
		$T_s = 80\text{ °C}$	17		A
$I_{FRM}$	$I_{FRM} = 2 \times I_{Fnom}$				A
$I_{FSM}$	$t_p = 10\text{ ms}; \text{half sine wave } T_j = 150\text{ °C}$	180			A
<b>Module</b>					
$I_{t(RMS)}$					A
$T_{vj}$		-40 ... +150			$^{\circ}\text{C}$
$T_{stg}$		-40 ... +125			$^{\circ}\text{C}$
$V_{isol}$	AC, 1 min.	2500			V

Characteristics		$T_s = 25\text{ °C}$ , unless otherwise specified				
Symbol	Conditions	min.	typ.	max.	Units	
<b>IGBT</b>						
$V_{GE(th)}$	$V_{GE} = V_{CE}, I_C = 0,6\text{ mA}$	4,5	5,5	6,5	V	
$I_{CES}$	$V_{GE} = 0\text{ V}, V_{CE} = V_{CES}$	$T_j = 25\text{ °C}$			0,1	mA
		$T_j = 125\text{ °C}$				mA
$I_{GES}$	$V_{CE} = 0\text{ V}, V_{GE} = 30\text{ V}$	$T_j = 25\text{ °C}$			480	nA
		$T_j = 125\text{ °C}$				nA
$V_{CE0}$		$T_j = 25\text{ °C}$	1,2		V	
		$T_j = 125\text{ °C}$	1,2		V	
$r_{CE}$	$V_{GE} = 15\text{ V}$	$T_j = 25\text{ °C}$	86		m $\Omega$	
		$T_j = 125\text{ °C}$	126		m $\Omega$	
$V_{CE(sat)}$	$I_{Cnom} = 15\text{ A}, V_{GE} = 15\text{ V}$	$T_j = 25\text{ °C}_{chiplev.}$	2	2,5	3	V
		$T_j = 125\text{ °C}_{chiplev.}$		3,1	3,7	V
$C_{ies}$	$V_{CE} = 25, V_{GE} = 0\text{ V}$	$f = 1\text{ MHz}$	1		nF	
$C_{oes}$			0,15		nF	
$C_{res}$			0,07		nF	
$Q_G$	$V_{GE} = 0 \dots 20\text{ V}$	90			nC	
$t_{d(on)}$	$R_{Gon} = 40\ \Omega$	$V_{CC} = 600\text{ V}$ $I_{Cnom} = 15\text{ A}$	35		ns	
$t_r$			45		ns	
$E_{on}$	$R_{Goff} = 40\ \Omega$	$T_j = 125\text{ °C}$ $V_{GE} = \pm 15\text{ V}$	2		mJ	
$t_{d(off)}$			250		ns	
$t_f$			70		ns	
$E_{off}$			1,8		mJ	
$R_{th(j-s)}$	per IGBT	1,4			K/W	

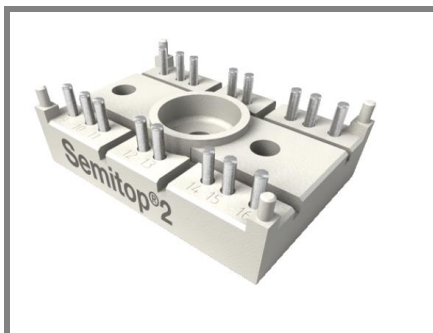

**SEMITOP<sup>®</sup> 2**

## IGBT Module

### SK20GB123

#### Preliminary Data

#### Features

- Compact design
- One screw mounting
- Heat transfer and isolation through direct copper bonded aluminium oxide ceramic (DCB)
- N-channel homogeneous silicon structure (NPT-Non punch-through IGBT)
- High short circuit capability
- Low tail current with low temperature dependence

#### Typical Applications

- Switching (not for linear use)
- Inverter
- Switched mode power supplies
- UPS

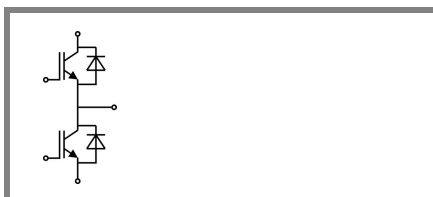

**GB**

#### Characteristics

Symbol	Conditions	min.	typ.	max.	Units	
<b>Inverse Diode</b>						
$V_F = V_{EC}$	$I_{Fnom} = 15 \text{ A}; V_{GE} = 0 \text{ V}$		$T_j = 25 \text{ }^\circ\text{C}_{\text{chiplev.}}$	2	2,5	V
			$T_j = 125 \text{ }^\circ\text{C}_{\text{chiplev.}}$	1,8	2,3	V
$V_{F0}$			$T_j = 125 \text{ }^\circ\text{C}$	1	1,2	V
$r_F$			$T_j = 125 \text{ }^\circ\text{C}$	53	73	mΩ
$I_{RRM}$	$I_{Fnom} = 15 \text{ A}$		$T_j = 125 \text{ }^\circ\text{C}$	16		A
$Q_{rr}$	$di/dt = -200 \text{ A}/\mu\text{s}$			2,7		μC
$E_{rr}$	$V_{CC} = 600\text{V}$			0,6		mJ
$R_{th(j-s)D}$	per diode			1,7		K/W
$M_s$	to heat sink M1			2		Nm
w				19		g

This is an electrostatic discharge sensitive device (ESDS), international standard IEC 60747-1, Chapter IX.

This technical information specifies semiconductor devices but promises no characteristics. No warranty or guarantee expressed or implied is made regarding delivery, performance or suitability.

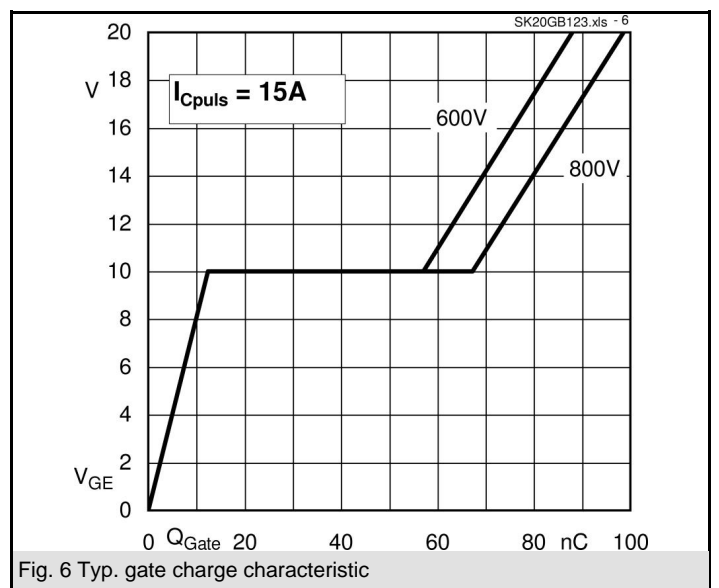
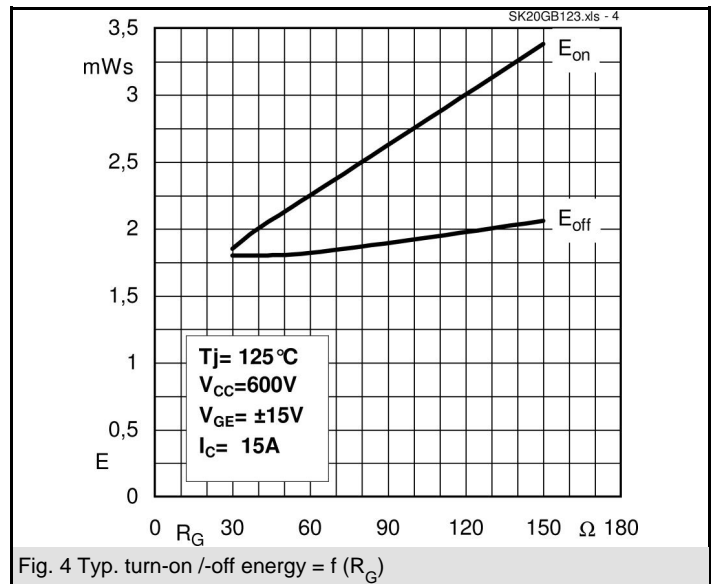
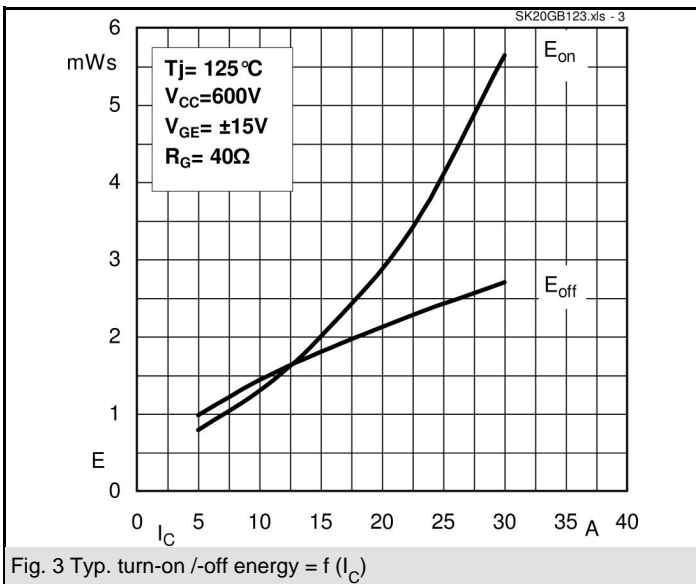
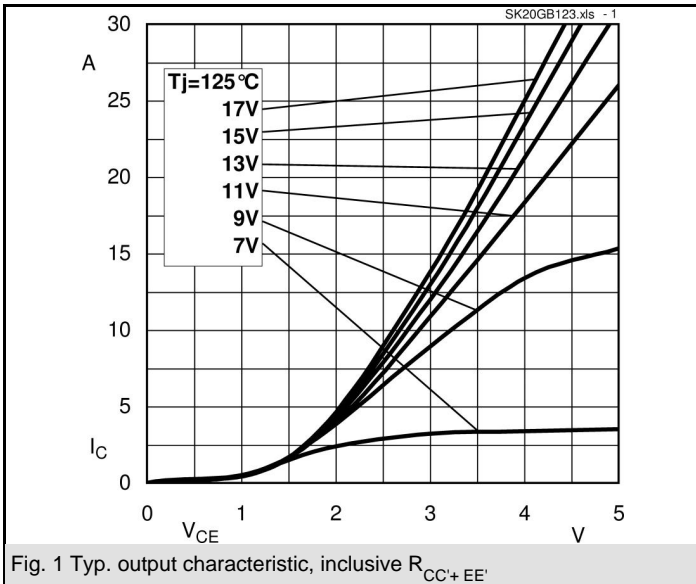

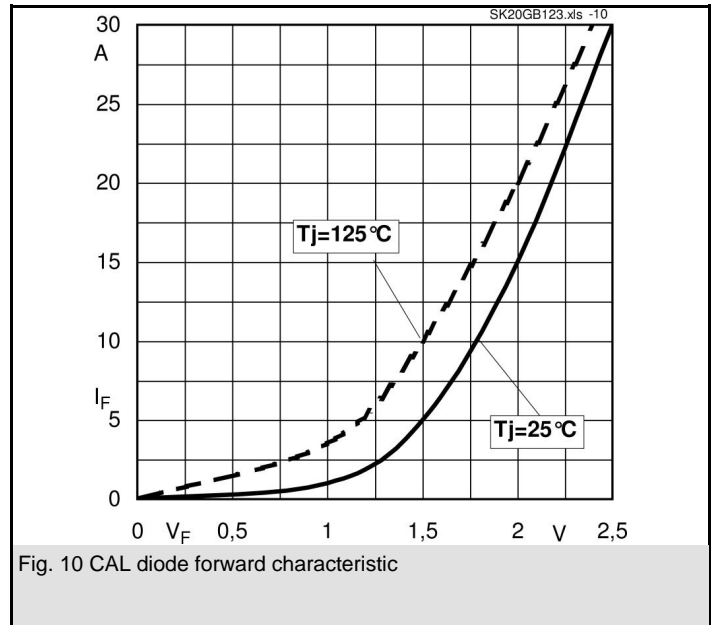
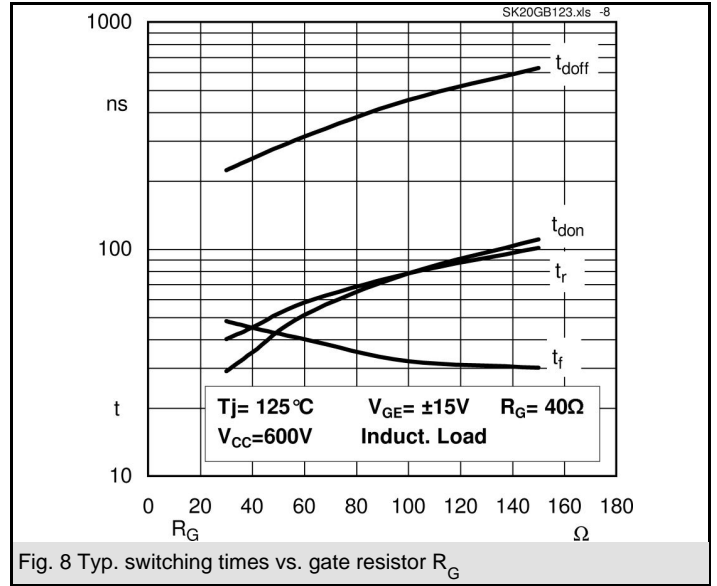
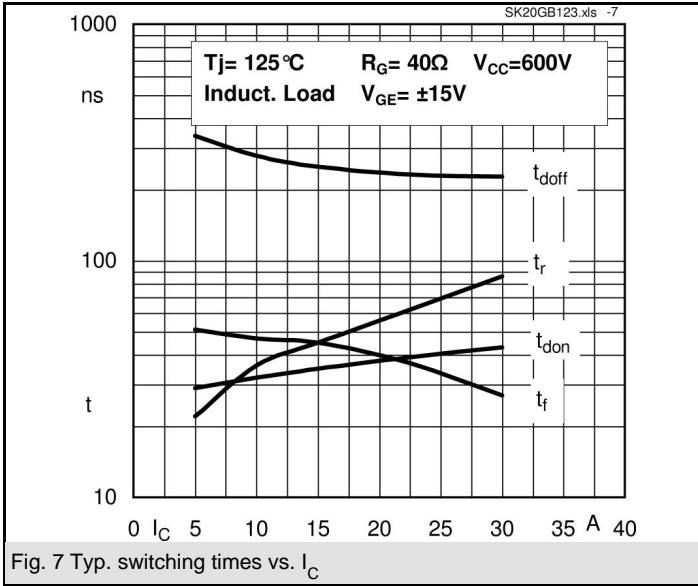

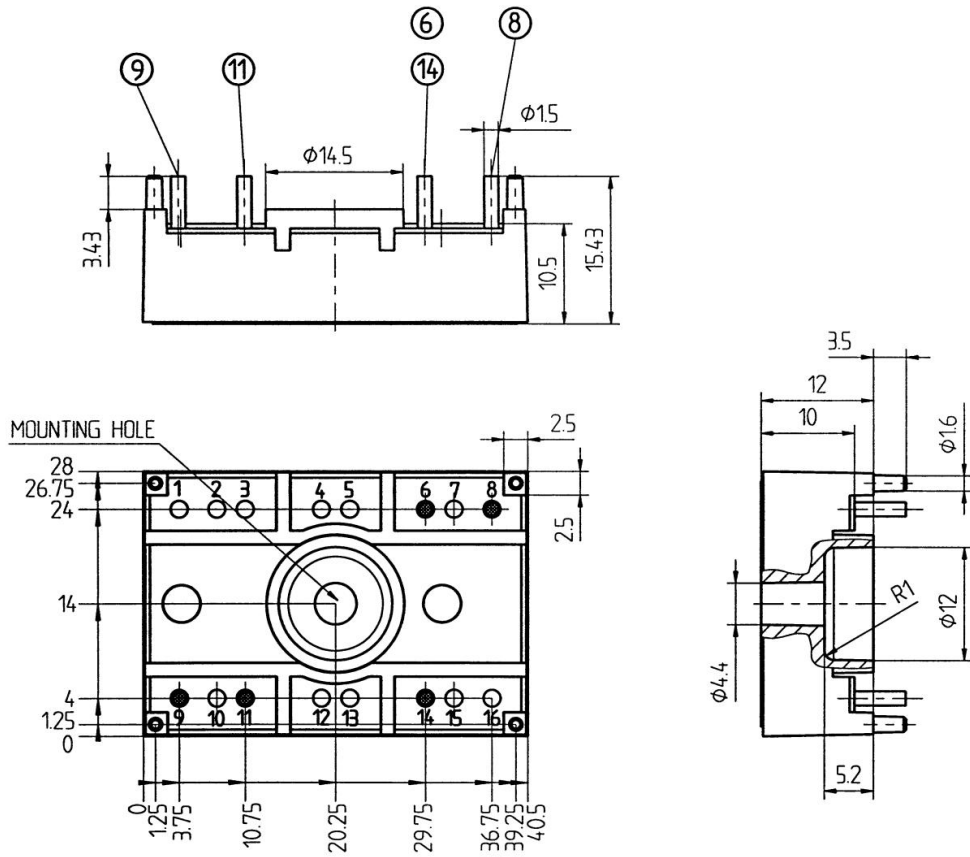

Case T8 (Suggested hole diameter, in the PCB, for solder pins and plastic mounting pins: 2mm)

