

# SK 95 DGL 126

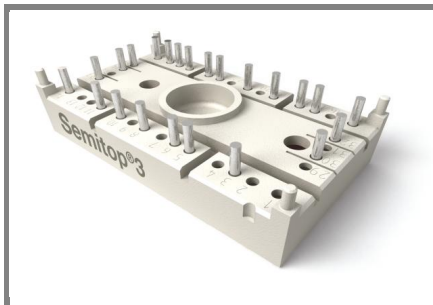

**SEMITOP<sup>®</sup> 3**

## 3-phase bridge rectifier + brake chopper

**SK 95 DGL 126**

Target Data

### Features

- Compact design
- One screw mounting
- Heat transfer and isolation through direct copper bonded aluminum oxide ceramic (DCB)
- Trench IGBT technology
- CAL Technology FWD

### Typical Applications

- Rectifier

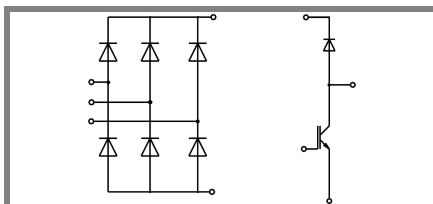

**DGL**

Absolute Maximum Ratings		$T_s = 25^\circ\text{C}$ , unless otherwise specified	
Symbol	Conditions	Values	Units
<b>IGBT - Chopper</b>			
$V_{CES}$		1200	V
$I_C$	$T_s = 25 (80)^\circ\text{C}$	40 (32)	A
$I_{CRM}$	$I_{CRM} = 2 \times I_{Cnom}$ , $t_p = 1 \text{ ms}$	70	A
$V_{GES}$		$\pm 20$	V
$T_j$		-40 ... +150	$^\circ\text{C}$
<b>Diode - Chopper</b>			
$I_F$	$T_s = 25 (80)^\circ\text{C}$	45 (35)	A
$I_{FRM}$	$I_{FRM} = 2 \times I_{Fnom}$ , $t_p = 1 \text{ ms}$	100	A
$T_j$		-40 ... +150	$^\circ\text{C}$
<b>Rectifier</b>			
$V_{RRM}$		1600	V
$I_D$	$T_s = 80^\circ\text{C}$	96	A
$I_{FSM} / I_{TSM}$	$t_p = 10 \text{ ms}$ , $\sin 180^\circ$ , $T_j = 25^\circ\text{C}$	700	A
$I_t^2$	$t_p = 10 \text{ ms}$ , $\sin 180^\circ$ , $T_j = 25^\circ\text{C}$	2450	$\text{A}^2\text{s}$
$T_j$		-40 ... +150	$^\circ\text{C}$
$T_{sol}$	Terminals, 10s	260	$^\circ\text{C}$
$T_{stg}$		-40 ... +125	$^\circ\text{C}$
$V_{isol}$	AC, 1 min. / 1s	2500 / 3000	V

Characteristics		$T_s = 25^\circ\text{C}$ , unless otherwise specified			
Symbol	Conditions	min.	typ.	max.	Units
<b>IGBT - Chopper</b>					
$V_{CEsat}$	$I_C = 35 \text{ A}$ , $T_j = 25 (125)^\circ\text{C}$		1,7 (2)	2,1	V
$V_{GE(th)}$	$V_{GE} = V_{CE}$ , $I_C = 1,5 \text{ mA}$	5	5,8	6,5	V
$V_{CE(TO)}$	$T_j = 25^\circ\text{C} (125)^\circ\text{C}$		1 (0,9)	1,2	V
$r_T$	$T_j = 25^\circ\text{C} (125)^\circ\text{C}$		20 (31)	26	$\text{m}\Omega$
$C_{ies}$	$V_{CE} = 25 \text{ V}$ , $V_{GE} = 0 \text{ V}$ , $f = 1 \text{ MHz}$		2,4		nF
$C_{oes}$	$V_{CE} = 25 \text{ V}$ , $V_{GE} = 0 \text{ V}$ , $f = 1 \text{ MHz}$		0,5		nF
$C_{res}$	$V_{CE} = 25 \text{ V}$ , $V_{GE} = 0 \text{ V}$ , $f = 1 \text{ MHz}$		0,4		nF
$R_{th(j-s)}$	per IGBT			1,05	K/W
$t_{d(on)}$	under following conditions		85		ns
$t_r$	$V_{CC} = 600 \text{ V}$ , $V_{GE} = \pm 15 \text{ V}$		30		ns
$t_{d(off)}$	$I_C = 30 \text{ A}$ , $T_j = 125^\circ\text{C}$		430		ns
$t_f$	$R_{Gon} = R_{Goff} = 22 \Omega$		90		ns
$E_{on}$	inductive load		4,6		mJ
$E_{off}$			4,3		mJ
<b>Diode - Chopper</b>					
$V_F = V_{EC}$	$I_F = 45 \text{ A}$ , $T_j = 25 (125)^\circ\text{C}$		1,5 (1,5)	1,77 (1,77)	V
$V_{(TO)}$	$T_j = 125^\circ\text{C}$		(0,92)		V
$r_T$	$T_j = 125^\circ\text{C}$		(13,4)		$\text{m}\Omega$
$R_{th(j-s)}$	per diode			1,2	K/W
$I_{RRM}$	under following conditions		30		A
$Q_{rr}$	$I_F = 50 \text{ A}$ , $V_R = 600 \text{ V}$		10		$\mu\text{C}$
$E_{rr}$	$V_{GE} = 0 \text{ V}$ , $T_j = 125^\circ\text{C}$ $di_F/dt = 500 \text{ A}/\mu\text{s}$				mJ
<b>Diode rectifier</b>					
$V_F$	$I_F = 35 \text{ A}$ , $T_j = 25^\circ\text{C}$			1,2	V
$V_{(TO)}$	$T_j = 150^\circ\text{C}$			0,8	V
$r_T$	$T_j = 150^\circ\text{C}$			11	$\text{m}\Omega$
$R_{th(j-s)}$	per diode			1,2	K/W
<b>Temperatur sensor</b>					
$R_{ts}$	%, $T_r = ( )^\circ\text{C}$		( )		$\Omega$
<b>Mechanical data</b>					
w			30		g
$M_s$	Mounting torque			2,5	Nm

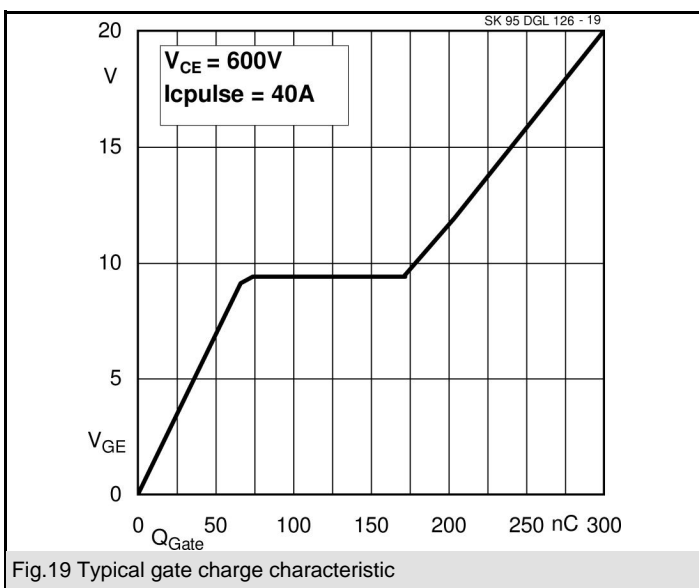
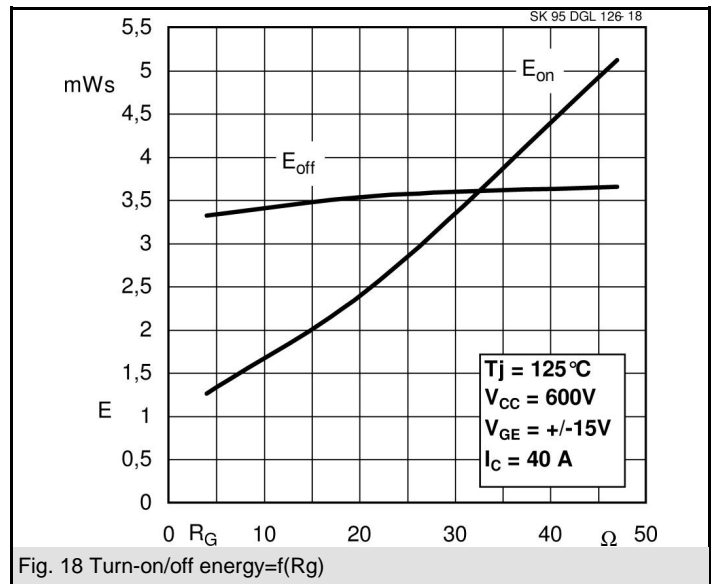
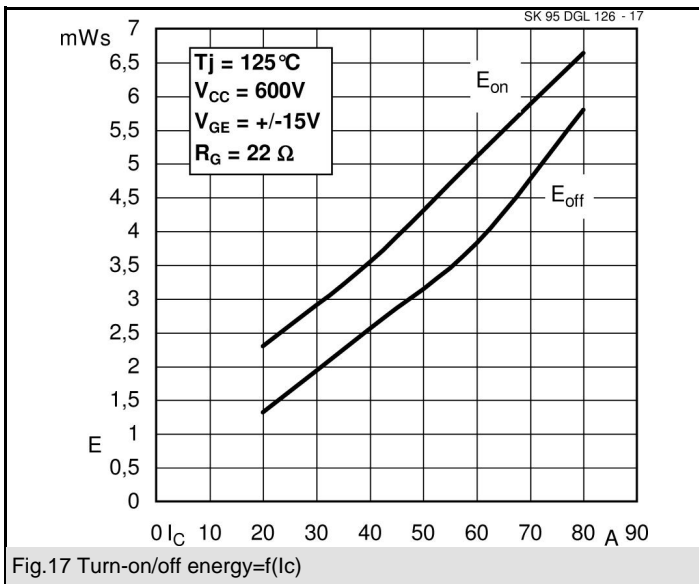
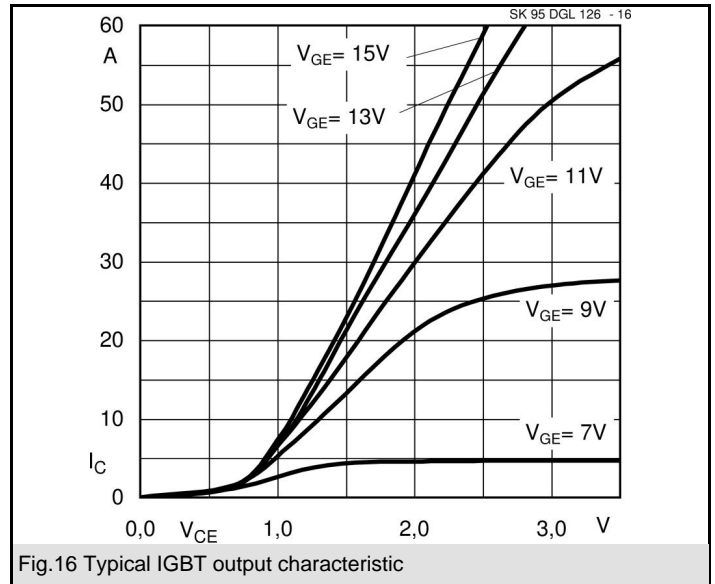
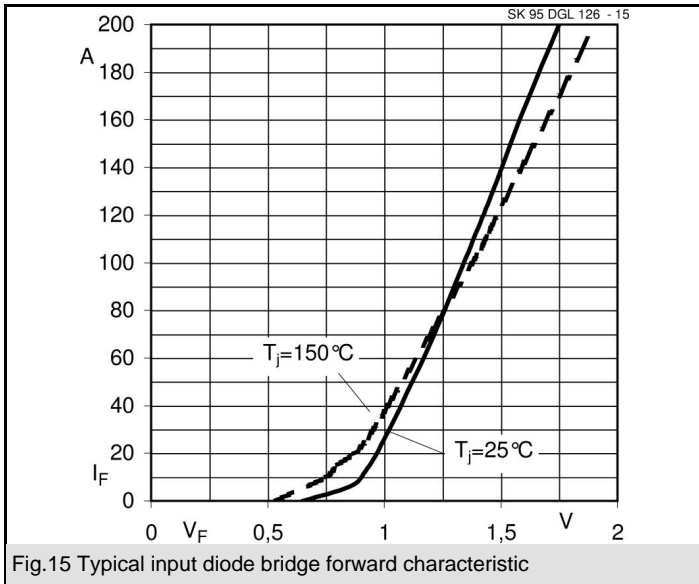

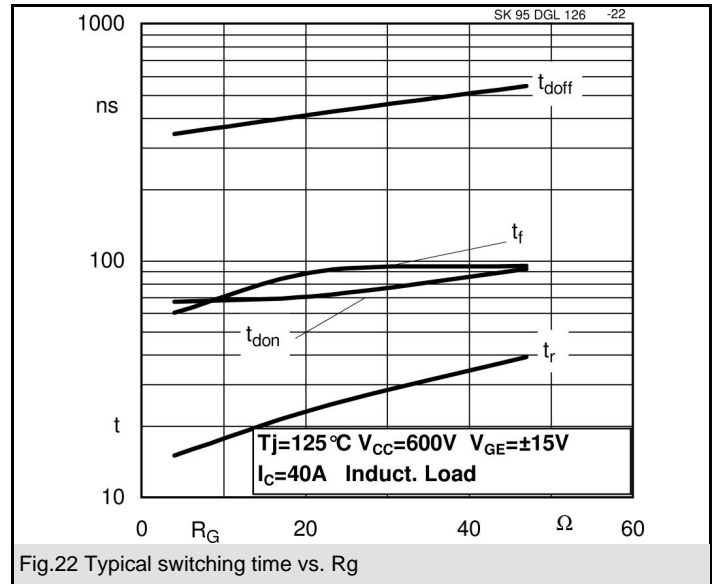
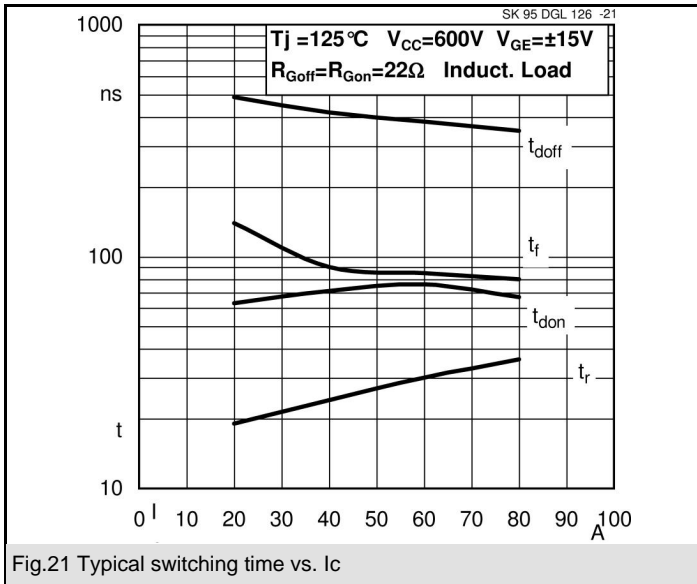

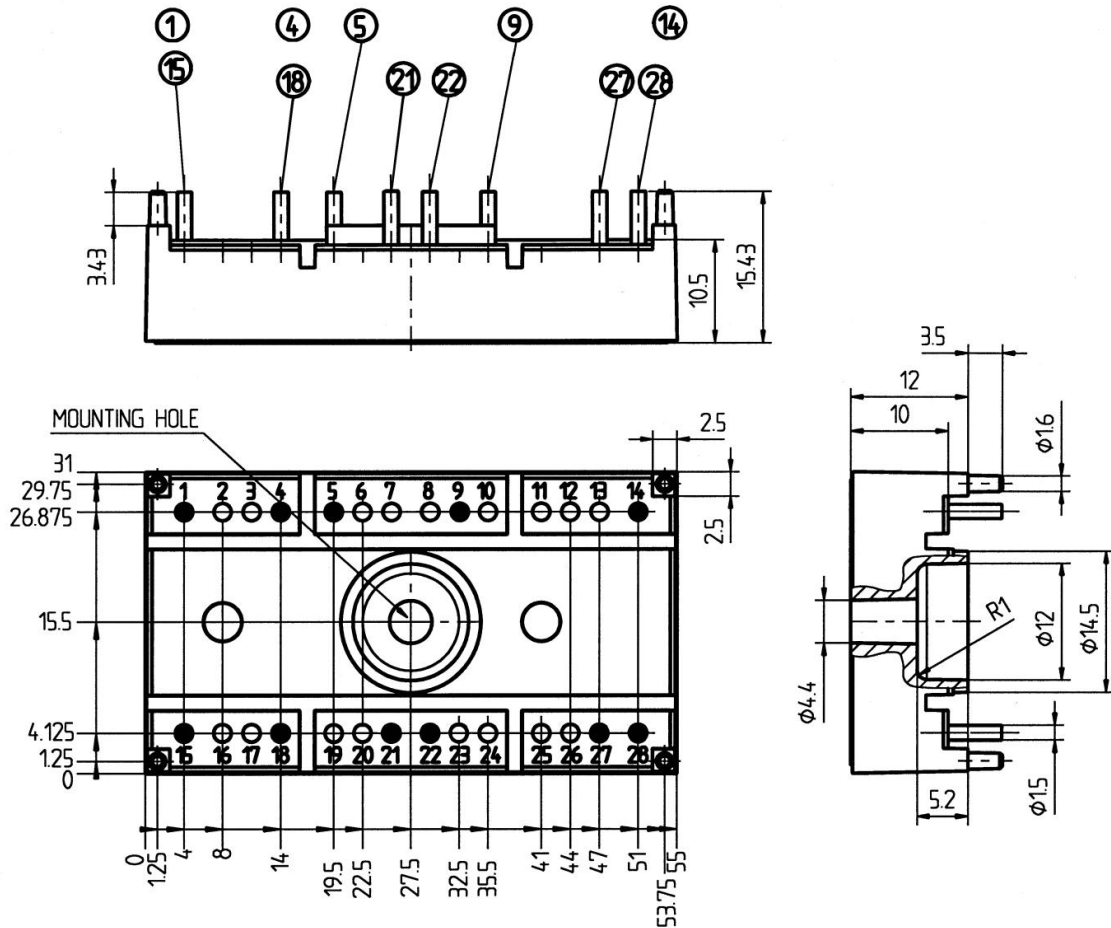

Case T 14 (Suggested hole diameter, in the PCB, for solder pins and plastic mounting pins: 2mm)

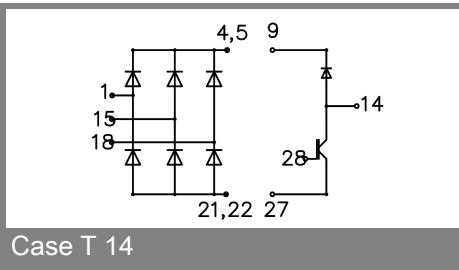

Case T 14

This is an electrostatic discharge sensitive device (ESDS), international standard IEC 60747-1, Chapter IX.

This technical information specifies semiconductor devices but promises no characteristics. No warranty or guarantee expressed or implied is made regarding delivery, performance or suitability.