



STGY40NC60VD

N-CHANNEL 50A - 600V - Max247
Very Fast PowerMESH™ IGBT

Table 1: General Features

TYPE	V _{CES}	V _{CE(sat)} (Max) @25°C	I _C @100°C
STGY40NC60VD	600 V	< 2.5 V	50 A

- HIGH CURRENT CAPABILITY
- HIGH FREQUENCY OPERATION UP TO 50 KHz
- LOSSES INCLUDE DIODE RECOVERY ENERGY
- OFF LOSSES INCLUDE TAIL CURRENT
- LOWER C_{RES} / C_{IES} RATIO
- VERY SOFT ULTRA FAST RECOVERY ANTIPARALLEL DIODE
- NEW GENERATION PRODUCTS WITH TIGHTER PARAMETER DISTRIBUTION

DESCRIPTION

Using the latest high voltage technology based on a patented strip layout, STMicroelectronics has designed an advanced family of IGBTs, the PowerMESH™ IGBTs, with outstanding performances. The suffix "V" identifies a family optimized for high frequency.

APPLICATIONS

- HIGH FREQUENCY INVERTERS
- SMPS and PFC IN BOTH HARD SWITCH AND RESONANT TOPOLOGIES
- UPS
- MOTOR DRIVERS

Table 2: Order Codes

SALES TYPE	MARKING	PACKAGE	PACKAGING
STGY40NC60VD	GY40NC60VD	Max247	TUBE

Figure 1: Package

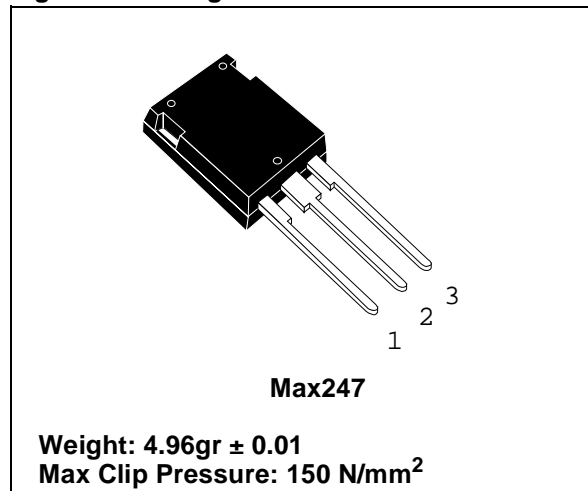

Figure 2: Internal Schematic Diagram

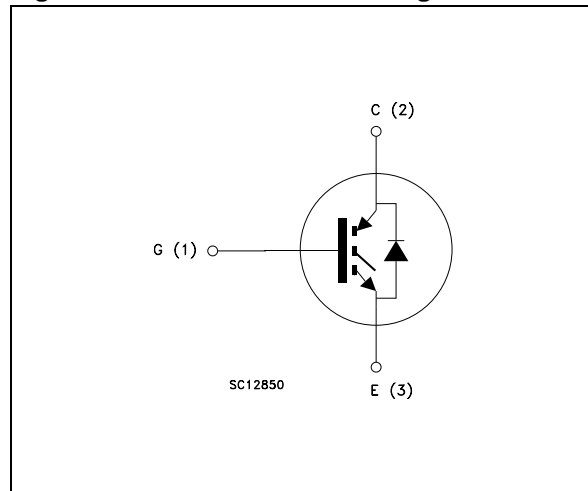

Table 3: Absolute Maximum ratings

Symbol	Parameter	Value	Symbol
V _{CES}	Collector-Emitter Voltage (V _{GS} = 0)	600	V
V _{ECR}	Reverse Battery Protection	20	V
V _{GE}	Gate-Emitter Voltage	± 20	V
I _C	Collector Current (continuous) at 25°C (#)	80	A
I _C	Collector Current (continuous) at 100°C (#)	50	A
I _{CM} (1)	Collector Current (pulsed)	200	A
I _F	Diode R _{MS} Forward Current at T _C =25°C	30	A
P _{TOT}	Total Dissipation at T _C = 25°C	260	W
	Derating Factor	2.08	W/°C
T _{stg}	Storage Temperature	- 55 to 150	°C
T _j	Operating Junction Temperature		

(1)Pulse width limited by max. junction temperature.

Table 4: Thermal Data

		Min.	Typ.	Max.	Unit
R _{thj-case}	Thermal Resistance Junction-case (IGBT)	--	--	0.48	°C/W
R _{thj-case}	Thermal Resistance Junction-case (Diode)	--	--	1.5	°C/W
R _{thj-amb}	Thermal Resistance Junction-ambient	--	--	50	°C/W
T _L	Maximum Lead Temperature for Soldering Purpose (1.6 mm from case, for 10 sec.)		300		°C

ELECTRICAL CHARACTERISTICS (T_{CASE} =25°C UNLESS OTHERWISE SPECIFIED)

Table 5: Off

Symbol	Parameter	Test Conditions	Min.	Typ.	Max.	Unit
V _{BR(CES)}	Collectro-Emitter Breakdown Voltage	I _C = 1 mA, V _{GE} = 0	600			V
I _{CES}	Collector-Emitter Leakage Current (V _{CE} = 0)	V _{GE} = Max Rating T _C =25°C T _C =125°C			10 1	µA mA
I _{GES}	Gate-Emitter Leakage Current (V _{CE} = 0)	V _{GE} = ± 20 V , V _{CE} = 0			± 100	nA

Table 6: On

Symbol	Parameter	Test Conditions	Min.	Typ.	Max.	Unit
V _{GE(th)}	Gate Threshold Voltage	V _{CE} = V _{GE} , I _C = 250 µA	3.75		5.75	V
V _{CE(SAT)}	Collector-Emitter Saturation Voltage	V _{GE} = 15 V, I _C = 40A, T _j = 25°C V _{GE} = 15 V, I _C = 40A, T _j = 125°C		1.9 1.7	2.5	V V

(#) Calculated according to the iterative formula:

$$I_C(T_C) = \frac{T_{JMAX} - T_C}{R_{THJ-C} \times V_{CESAT(MAX)}(T_C, I_C)}$$

ELECTRICAL CHARACTERISTICS (CONTINUED)

Table 7: Dynamic

Symbol	Parameter	Test Conditions	Min.	Typ.	Max.	Unit
$g_{fs}(1)$	Forward Transconductance	$V_{CE} = 15 \text{ V}$, $I_C = 20 \text{ A}$		20		S
C_{ies} C_{oes} C_{res}	Input Capacitance Output Capacitance Reverse Transfer Capacitance	$V_{CE} = 25 \text{ V}$, $f = 1 \text{ MHz}$, $V_{GE} = 0$		4550 350 105		pF pF pF
Q_g Q_{ge} Q_{gc}	Total Gate Charge Gate-Emitter Charge Gate-Collector Charge	$V_{CE} = 390 \text{ V}$, $I_C = 40 \text{ A}$, $V_{GE} = 15 \text{ V}$, (see Figure 21)		214 30 96		nC nC nC
I_{CL}	Turn-Off SOA Minimum Current	$V_{clamp} = 480 \text{ V}$, $T_j = 150^\circ\text{C}$ $R_G = 100 \Omega$, $V_{GE} = 15 \text{ V}$	200			A

Table 8: Switching On

Symbol	Parameter	Test Conditions	Min.	Typ.	Max.	Unit
$t_{d(on)}$ t_r $(di/dt)_{on}$ $E_{on}(2)$	Turn-on Delay Time Current Rise Time Turn-on Current Slope Turn-on Switching Losses	$V_{CC} = 390 \text{ V}$, $I_C = 40 \text{ A}$ $R_G = 3.3 \Omega$, $V_{GE} = 15 \text{ V}$, $T_j = 25^\circ\text{C}$ (see Figure 19)		43 17 2060 330	450	ns ns A/ μs μJ
$t_{d(on)}$ t_r $(di/dt)_{on}$ $E_{on}(2)$	Turn-on Delay Time Current Rise Time Turn-on Current Slope Turn-on Switching Losses	$V_{CC} = 390 \text{ V}$, $I_C = 40 \text{ A}$ $R_G = 3.3 \Omega$, $V_{GE} = 15 \text{ V}$, $T_j = 125^\circ\text{C}$ (see Figure 19)		42 19 1900 640		ns ns A/ μs μJ

2) E_{on} is the turn-on losses when a typical diode is used in the test circuit in figure 2. If the IGBT is offered in a package with a co-pack diode, the co-pack diode is used as external diode. IGBTs & DIODE are at the same temperature (25°C and 125°C)

Table 9: Switching Off

Symbol	Parameter	Test Conditions	Min.	Typ.	Max.	Unit
$t_r(V_{off})$ $t_{d(off)}$ t_f $E_{off}(3)$ E_{ts}	Off Voltage Rise Time Turn-off Delay Time Current Fall Time Turn-off Switching Loss Total Switching Loss	$V_{CC} = 390 \text{ V}$, $I_C = 40 \text{ A}$, $R_{GE} = 3.3 \Omega$, $V_{GE} = 15 \text{ V}$ $T_j = 25^\circ\text{C}$ (see Figure 19)		25 140 45 720 1050	970 1420	ns ns ns μJ μJ
$t_r(V_{off})$ $t_{d(off)}$ t_f $E_{off}(3)$ E_{ts}	Off Voltage Rise Time Turn-off Delay Time Current Fall Time Turn-off Switching Loss Total Switching Loss	$V_{CC} = 390 \text{ V}$, $I_C = 40 \text{ A}$, $R_{GE} = 3.3 \Omega$, $V_{GE} = 15 \text{ V}$ $T_j = 125^\circ\text{C}$ (see Figure 19)		60 170 77 1400 2040		ns ns ns μJ μJ

(3) Turn-off losses include also the tail of the collector current.

Table 10: Collector-Emitter Diode

Symbol	Parameter	Test Conditions	Min.	Typ.	Max.	Unit
V_f	Forward On-Voltage	$I_f = 20\text{ A}$ $I_f = 20\text{ A}, T_j = 125\text{ °C}$		1.5 1	2.2	V V
t_{rr} t_a Q_{rr} I_{rrm} S	Reverse Recovery Time Reverse Recovery Charge Reverse Recovery Current Softness factor of the diode	$I_f = 20\text{ A}, V_R = 40\text{ V},$ $T_j = 25\text{ °C}, di/dt = 100\text{ A}/\mu\text{s}$ (see Figure 22)		44 32 66 3 0.375		ns ns nC A A
t_{rr} t_a Q_{rr} I_{rrm} S	Reverse Recovery Time Reverse Recovery Charge Reverse Recovery Current Softness factor of the diode	$I_f = 20\text{ A}, V_R = 40\text{ V},$ $T_j = 125\text{ °C}, di/dt = 100\text{ A}/\mu\text{s}$ (see Figure 22)		88 56 237 5.4 0.57		ns ns nC A A

Figure 3: Output Characteristics

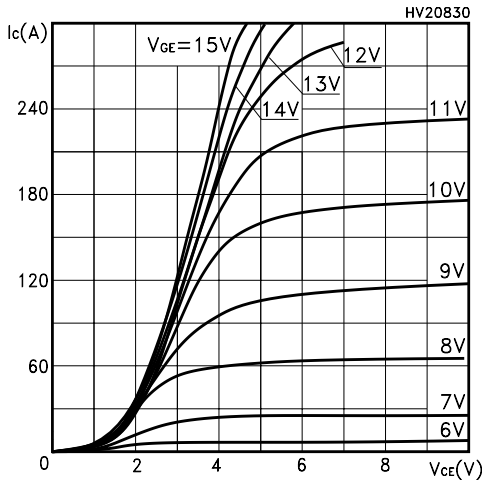

Figure 4: Transconductance

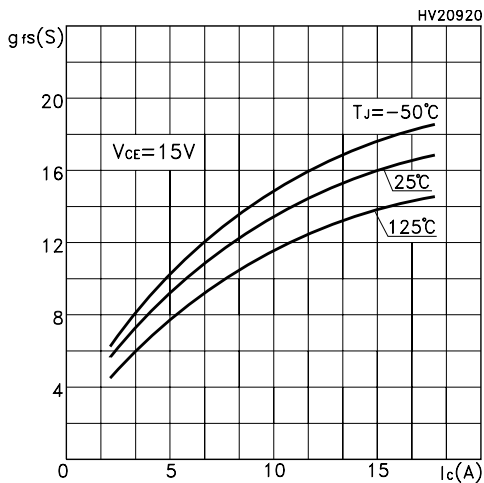

Figure 5: Collector-Emitter On Voltage vs Collector Current

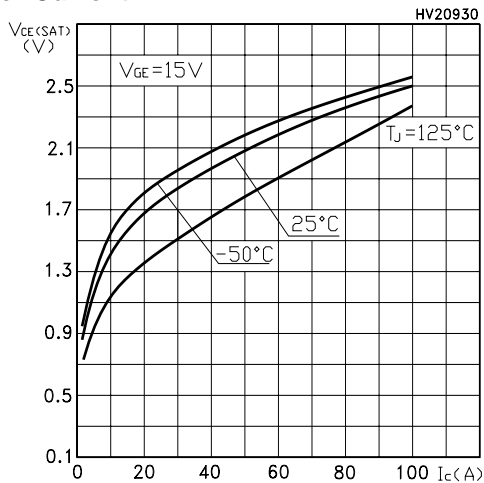

Figure 6: Transfer Characteristics

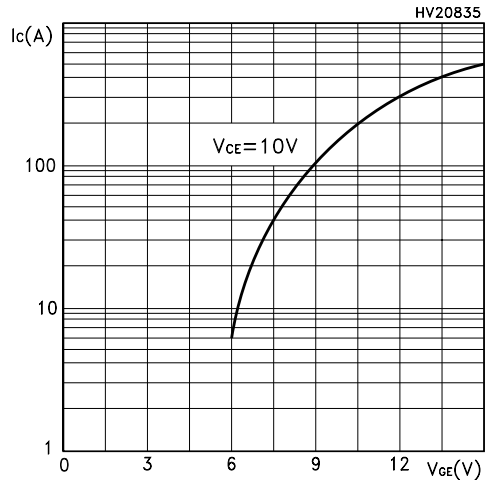

Figure 7: Collector-Emitter On Voltage vs Temperature

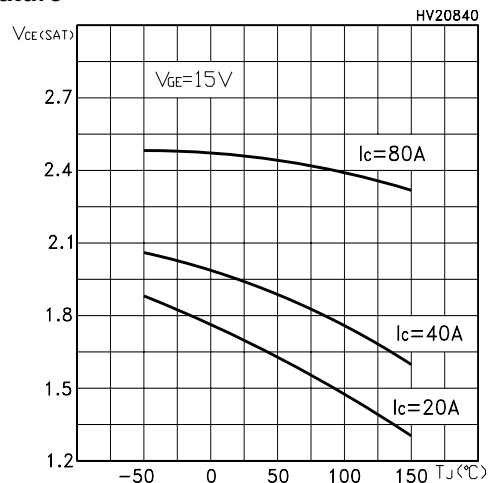

Figure 8: Normalized Gate Threshold vs Temperature

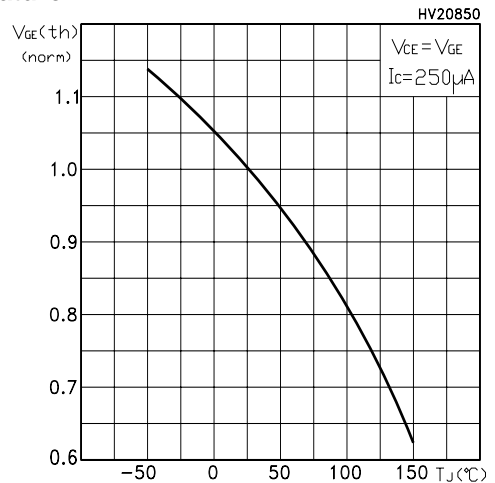

Figure 9: Normalized Breakdown Voltage vs Temperature

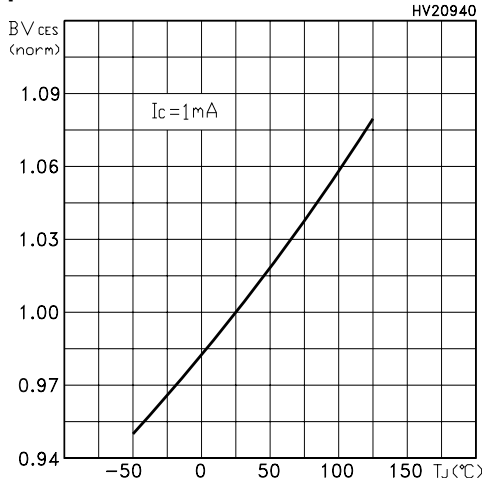

Figure 10: Capacitance Variations

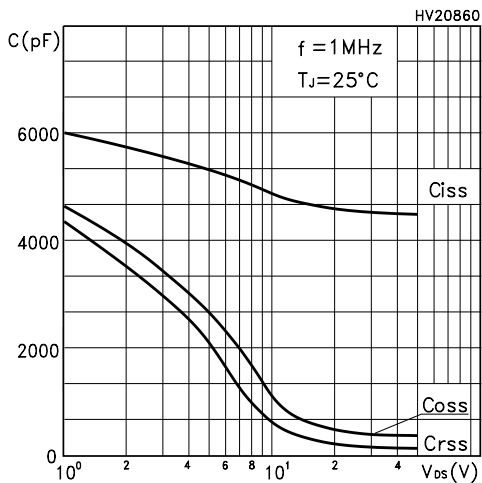

Figure 11: Total Switching Losses vs Gate Resistance

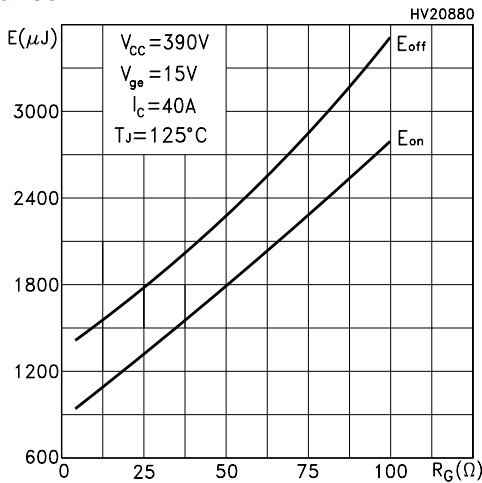

Figure 12: Gate Charge vs Gate-Emitter Voltage

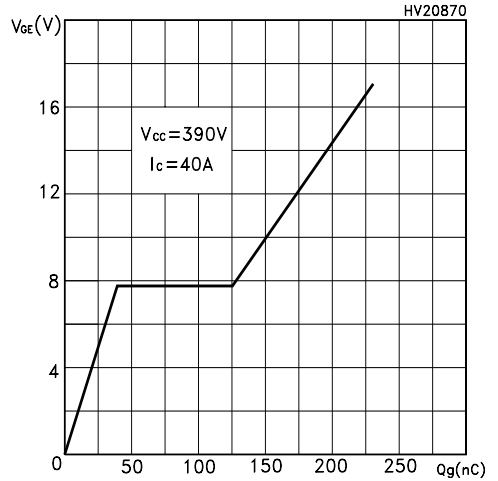

Figure 13: Total Switching Losses vs Temperature

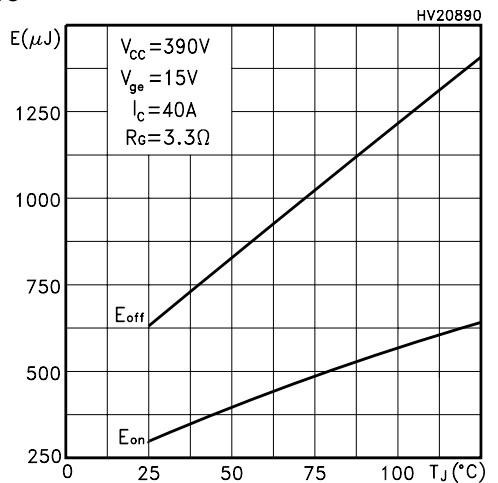

Figure 14: Total Switching Losses vs Collector Current

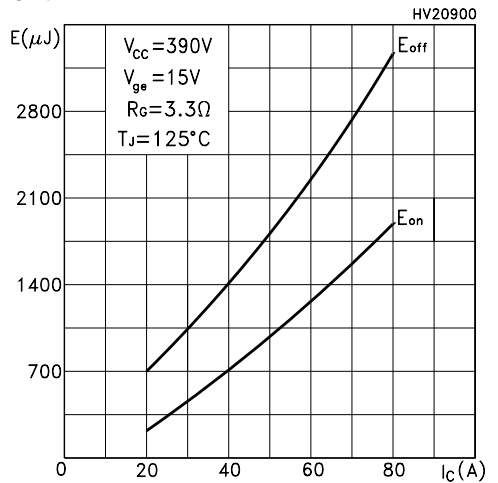

Figure 15: Thermal Impedance

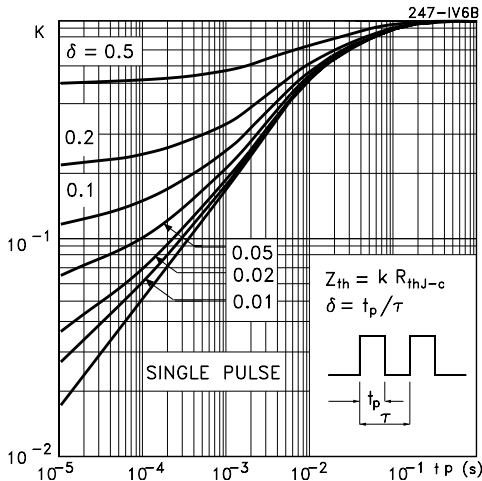

Figure 16: Turn-Off SOA

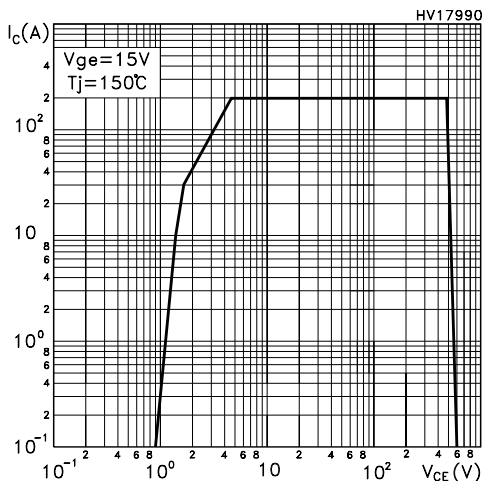

Figure 17: Emitter-Collector Diode Characteristics

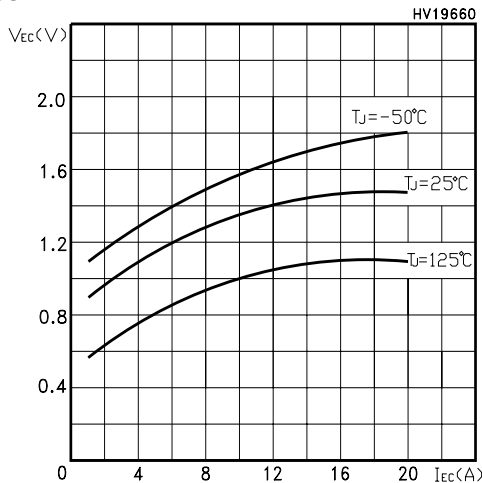
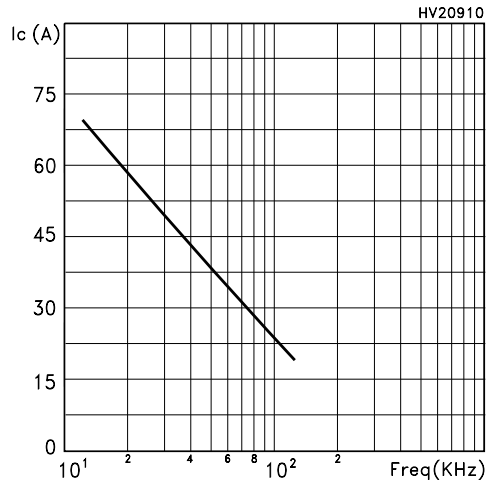

Figure 18: Ic vs Frequency



For a fast IGBT suitable for high frequency applications, the typical collector current vs. maximum operating frequency curve is reported. That frequency is defined as follows:

$$f_{MAX} = (P_D - P_C) / (E_{ON} + E_{OFF})$$

1) The maximum power dissipation is limited by maximum junction to case thermal resistance:

$$P_D = \Delta T / R_{THJ-C}$$

considering $\Delta T = T_J - T_C = 125^\circ C - 75^\circ C = 50^\circ C$

2) The conduction losses are:

$$P_C = I_C * V_{CE(SAT)} * \delta$$

with 50% of duty cycle, V_{CESAT} typical value @ $125^\circ C$.

3) Power dissipation during ON & OFF commutations is due to the switching frequency:

$$P_{SW} = (E_{ON} + E_{OFF}) * freq.$$

4) Typical values @ $125^\circ C$ for switching losses are used (test conditions: $V_{CE} = 390V$, $V_{GE} = 15V$, $R_G = 3.3 \text{ Ohm}$). Furthermore, diode recovery energy is included in the E_{ON} (see note 2), while the tail of the collector current is included in the E_{OFF} measurements (see note 3).

Figure 19: Test Circuit for Inductive Load Switching

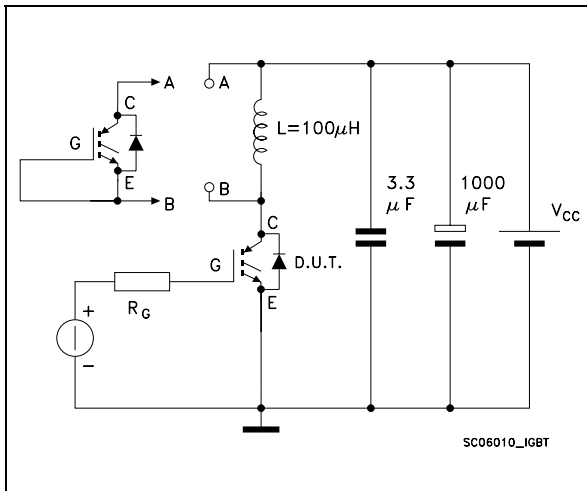

Figure 20: Switching Waveforms

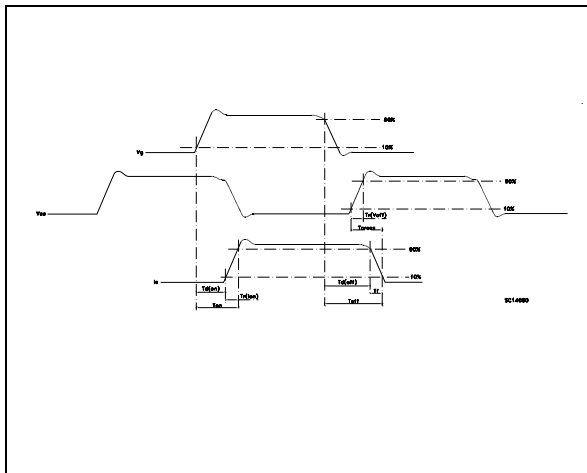

Figure 21: Gate Charge Test Circuit

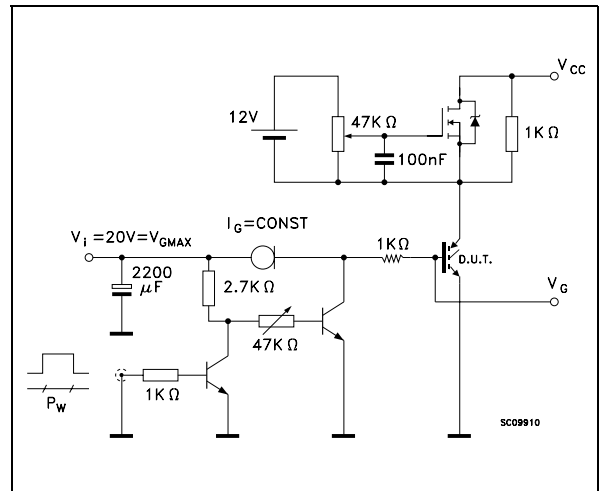

Figure 22: Diode Recovery Times Waveform

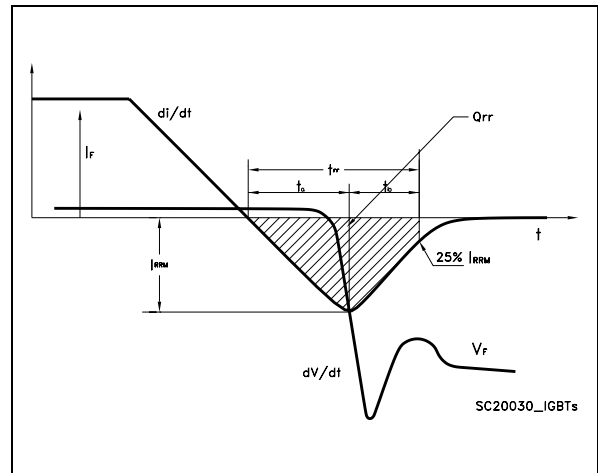
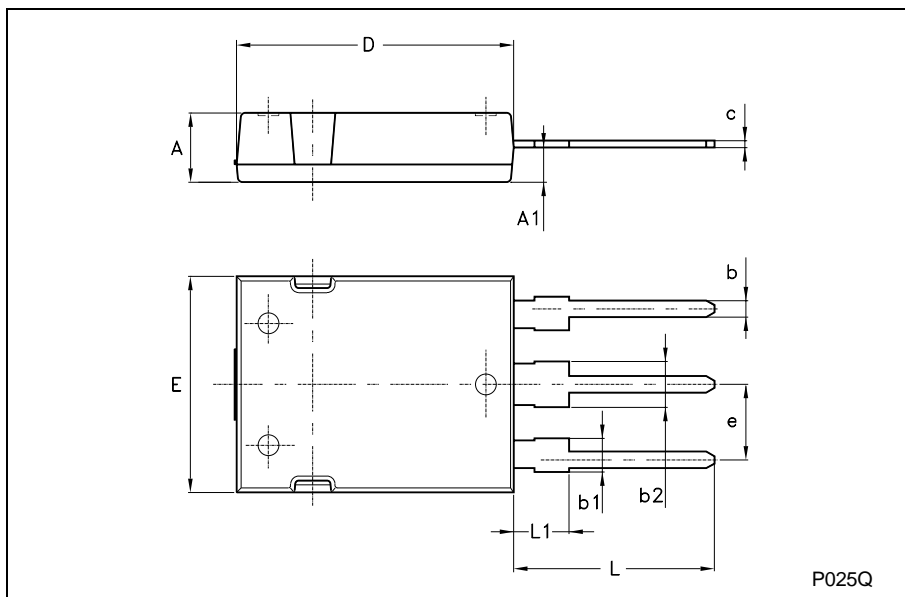

Table 11: Revision History

Date	Revision	Description of Changes
07-June-2004	7	Stylesheet update. Added Max Values see Table 8 and 9 Added Figure 22
14-Jul-2004	8	Figure 19 updated, some datas have been modified

Max247 MECHANICAL DATA

DIM.	mm			inch		
	MIN.	TYP.	MAX.	MIN.	TYP.	MAX.
A	4.70		5.30			
A1	2.20		2.60			
b	1.00		1.40			
b1	2.00		2.40			
b2	3.00		3.40			
c	0.40		0.80			
D	19.70		20.30			
e	5.35		5.55			
E	15.30		15.90			
L	14.20		15.20			
L1	3.70		4.30			



P025Q

Information furnished is believed to be accurate and reliable. However, STMicroelectronics assumes no responsibility for the consequences of use of such information nor for any infringement of patents or other rights of third parties which may result from its use. No license is granted by implication or otherwise under any patent or patent rights of STMicroelectronics. Specifications mentioned in this publication are subject to change without notice. This publication supersedes and replaces all information previously supplied. STMicroelectronics products are not authorized for use as critical components in life support devices or systems without express written approval of STMicroelectronics.

The ST logo is a registered trademark of STMicroelectronics
All other names are the property of their respective owners

© 2004 STMicroelectronics - All Rights Reserved
STMicroelectronics GROUP OF COMPANIES

Australia - Belgium - Brazil - Canada - China - Czech Republic - Finland - France - Germany - Hong Kong - India - Israel - Italy - Japan - Malaysia - Malta - Morocco - Singapore - Spain - Sweden - Switzerland - United Kingdom - United States.