

## Features

- For surface mounted applications
- Low profile package
- Built-in strain relief
- Easy pick and place
- Fast recovery times for high efficiency
- Plastic package has Underwriters Laboratory Flammability Classification 94V-0
- High temperature soldering: 260°C/10 seconds at terminals

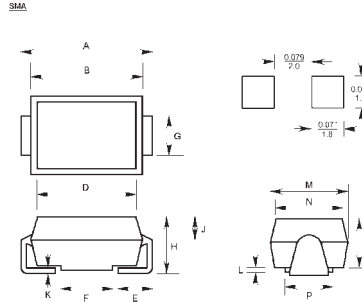

## Mechanical Data

- **Case:** SMA molded plastic
- **Terminals:** Solder plated solderable per MIL-STD-750, method 2026
- **Polarity:** Indicated by cathode band
- **Weight:** 0.004 ounce, 0.113 gram

DIM	DIMENSIONS				Note
	Inches		mm		
A	M in.	Max.	M in.	Max.	
A	0.216	0.226	5.48	5.74	
B	0.176	0.182	4.48	4.63	
C	0.094	0.100	2.40	2.55	
D	0.170	0.176	4.33	4.48	
E	0.039	0.055	1.00	1.40	
F	0.060	0.081	2.03	2.07	
G	0.068	0.083	1.72	2.10	
H	0.112	0.118	2.85	3.00	
J	0.057	-	1.44	-	
K	-	0.018	-	0.45	
L	0.016	-	0.40	-	
M	0.109	0.115	2.77	2.93	
N	0.105	0.107	2.67	2.73	
P	0.078	0.081	2.00	2.05	

## Maximum Ratings and Electrical Characteristics @25°C unless otherwise specified

	Symbols	SRA7	SRA8	SRA9	Units
Maximum repetitive peak reverse voltage	$V_{RRM}$	400	600	1000	Volts
Maximum RMS voltage	$V_{RMS}$	280	420	700	Volts
Maximum DC blocking voltage	$V_{DC}$	400	600	1000	Volts
Average forward current at $T_J=90^\circ\text{C}$	$I_{(AV)}$	1.0			Amp
Peak forward surge current 8.3mS single half sine-wave	$I_{FSM}$	30.0			Amps
Maximum instantaneous forward voltage at $I_{FM}=1.0\text{A}$ ; $T_J=25^\circ\text{C}$ (Note 1)	$V_F$	1.3			Volts
Maximum DC reverse current at rated DC blocking voltage $T_J=25^\circ\text{C}$ / $T_J=125^\circ\text{C}$	$I_R$	5.0 / 200.0			$\mu\text{A}$
Maximum reverse recovery time (Note 2)	$T_{rr}$	150		250	nS
Typical junction capacitance (Note 3)	$C_J$	50.0			pF
Maximum thermal resistance	$R_{\theta JL}$	15			$^\circ\text{C/W}$
Operating and Storage temperature range	$T_J, T_{STG}$	-50 to +150			$^\circ\text{C}$

**Notes:**

- (1) Pulse test: Pulse width 300uSec, Duty cycle 1%
- (2) Reverse recovery test conditions:  $I_F=0.5\text{A}$ ,  $I_R=1.0\text{A}$ ,  $I_T=0.25\text{A}$
- (3) Measured at 1.0MHz and applied reverse voltage of 4.0 volts

# RATINGS AND CHARACTERISTIC CURVES

Figure 1  
Typical Forward Characteristics

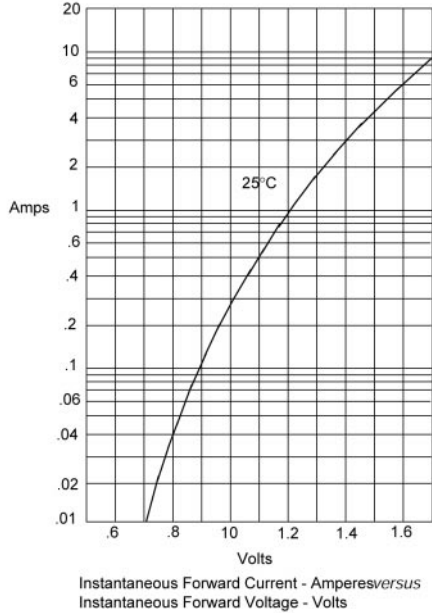

Figure 2  
Forward Derating Curve

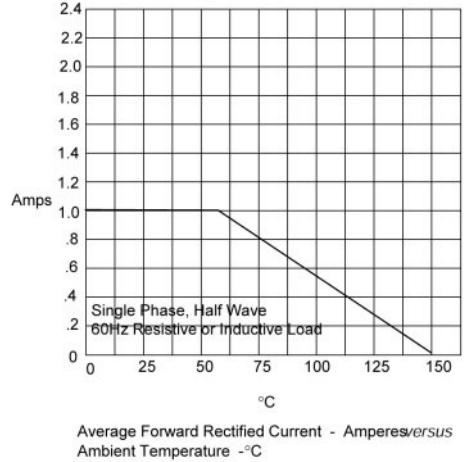
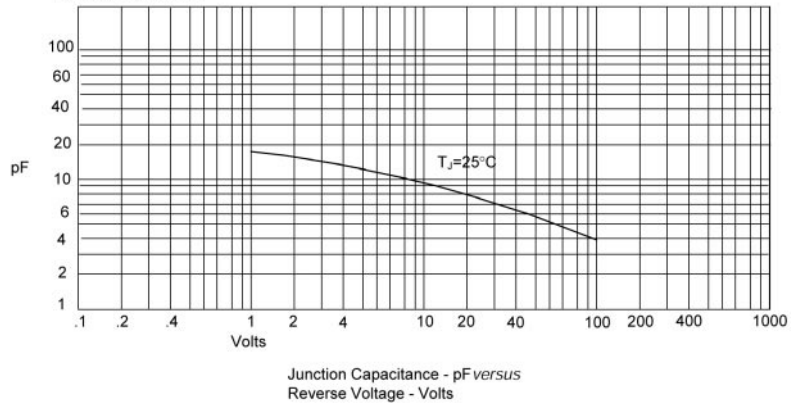
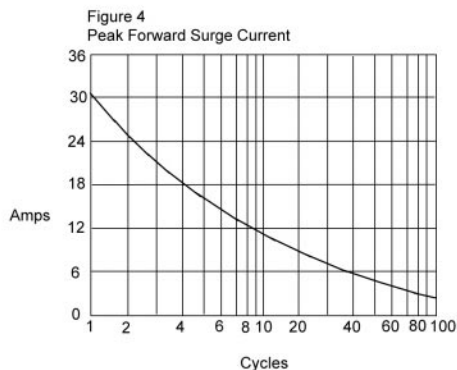

Figure 3  
Junction Capacitance



# RATINGS AND CHARACTERISTIC CURVES



Peak Forward Surge Current - Amperes *versus* Number Of Cycles At 60Hz - Cycles

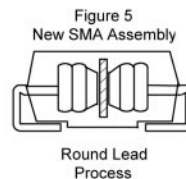
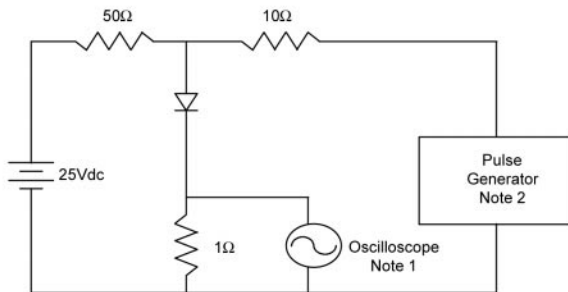

Figure 6  
Reverse Recovery Time Characteristic And Test Circuit Diagram



- Notes:
1. Rise Time = 7ns max.  
Input impedance = 1 megohm, 22pF
  2. Rise Time = 10ns max.  
Source impedance = 50 ohms
  3. Resistors are non-inductive

