

SP - 3ML

The SP - 3ML, a silicon photodiode mounted in a TO - 5 type header with clear epoxy encapsulation, has wide angular response and is relatively low - cost as compared to TO - 18 can - type devices.

FEATURES

- High - output power
- Relatively low - cost against metal can package
- Wide angular response

APPLICATIONS

- Optical detectors
- Infrared sensors
- Smoke detectors

DIMENSIONS

(Unit : mm)

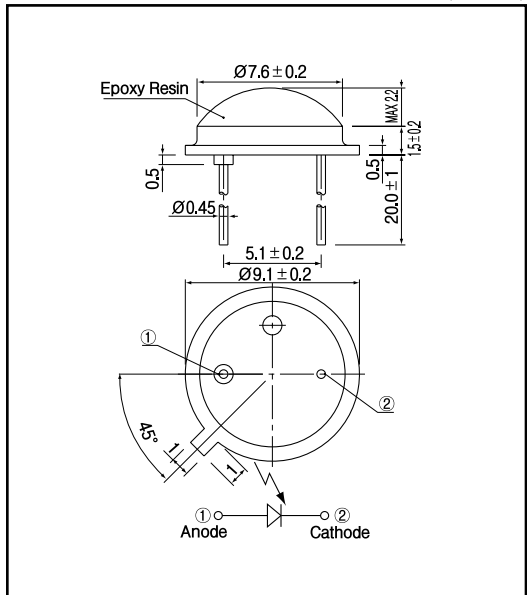

MAXIMUM RATINGS

(Ta=25)

Item	Symbol	Rating	Unit
Reverse voltage	V _r	5	V
Operating temp.	Topr.	- 20 ~ + 80	
Storage temp.	Tstg.	- 30 ~ + 100	
Soldering temp. *1	Tsol.	260	

*1. For MAX.5 seconds at the position of 2 mm from the package

ELECTRO-OPTICAL CHARACTERISTICS

(Ta=25)

Item	Symbol	Conditions	Min.	Typ.	Max.	Unit.
Open circuit voltage	V _{oc}	E _v = 1,000lx *2		0.38		V
Short circuit current	I _{sc}		54	75		μA
Dark current	I _d		-	-	-	μA
Curve factor	C.F.		0.55			-
Capacitance	C _t	V=0V, f=1MHz		480		pF
Temperature coefficient of V _{oc}	t			- 2.2		mV/
Temperature coefficient of I _{sc}	t			0.18		%/
Spectral sensitivity				450~1,050		nm
Peak wavelength	p			900		nm
Half angle				± 60		deg.

*2. Color temp. = 2856K standard Tungsten lamp

Photo diodes

SP - 3ML

Light current Vs. Forward voltage

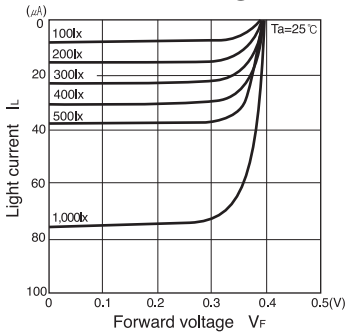

Short circuit current Vs. Illuminance

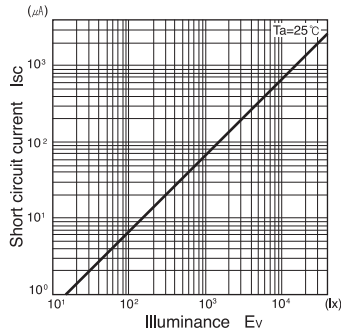

Dark current Vs. Ambient temperature

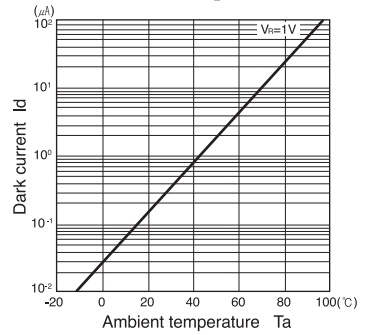

Relative sensitivity Vs. Wavelength

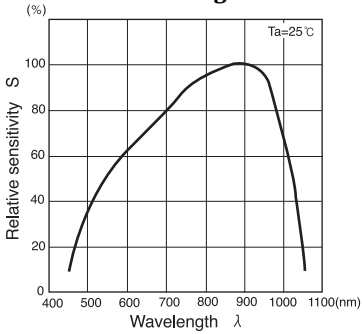

Dark current Vs. Reverse voltage

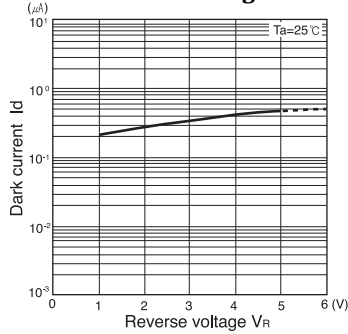

Radiant Pattern

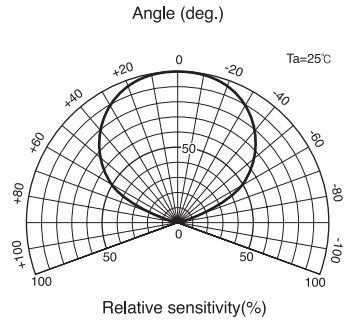

Capacitance between terminals Vs. Reverse voltage

