

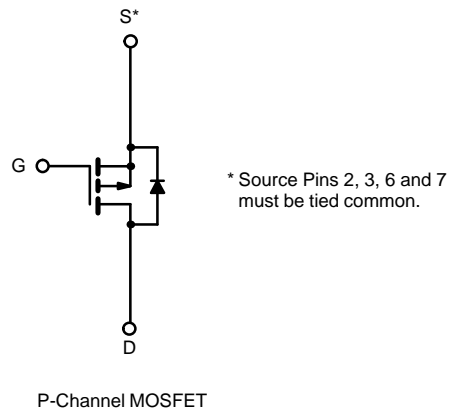

P-Channel 20-V (D-S) MOSFET

PRODUCT SUMMARY		
V_{DS} (V)	$r_{DS(on)}$ (Ω)	I_D (A)
-20	0.09 @ $V_{GS} = -10$ V	± 3.2
	0.16 @ $V_{GS} = -4.5$ V	± 2.4

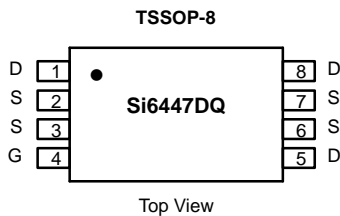

ABSOLUTE MAXIMUM RATINGS ($T_A = 25^\circ\text{C}$ UNLESS OTHERWISE NOTED)				
Parameter	Symbol	Limit	Unit	
Drain-Source Voltage	V_{DS}	-20	V	
Gate-Source Voltage	V_{GS}	± 20		
Continuous Drain Current ($T_J = 150^\circ\text{C}$) ^a	$T_A = 25^\circ\text{C}$	I_D	± 3.2	A
	$T_A = 70^\circ\text{C}$		± 2.5	
Pulsed Drain Current	I_{DM}	± 20		
Continuous Source Current (Diode Conduction) ^a	I_S	-1.7		
Maximum Power Dissipation ^a	$T_A = 25^\circ\text{C}$	P_D	1.5	W
	$T_A = 70^\circ\text{C}$		1.0	
Operating Junction and Storage Temperature Range	T_J, T_{stg}	-55 to 150	$^\circ\text{C}$	

THERMAL RESISTANCE RATINGS			
Parameter	Symbol	Limit	Unit
Maximum Junction-to-Ambient ^a	R_{thJA}	83	$^\circ\text{C}/\text{W}$

Notes

a. Surface Mounted on FR4 Board, $t \leq 10$ sec.

For SPICE model information via the Worldwide Web: <http://www.vishay.com/www/product/spice.htm>



SPECIFICATIONS (T_J = 25°C UNLESS OTHERWISE NOTED)

Parameter	Symbol	Test Condition	Min	Typ	Max	Unit
Static						
Gate Threshold Voltage	V _{GS(th)}	V _{DS} = V _{GS} , I _D = -250 μA	-1.0			V
Gate-Body Leakage	I _{GSS}	V _{DS} = 0 V, V _{GS} = ±20 V			± 100	nA
Zero Gate Voltage Drain Current	I _{DSS}	V _{DS} = -20 V, V _{GS} = 0 V			-1	μA
		V _{DS} = -10 V, V _{GS} = 0 V, T _J = 70°C			-5	
On-State Drain Current ^a	I _{D(on)}	V _{DS} = -5 V, V _{GS} = -10 V	-14			A
		V _{DS} = -5 V, V _{GS} = -4.5 V	-2.5			
Drain-Source On-State Resistance ^a	r _{DS(on)}	V _{GS} = -10 V, I _D = 3.2 A		0.060	0.09	Ω
		V _{GS} = -4.5 V, I _D = 2.0 A		0.100	0.16	
Forward Transconductance ^a	g _{fs}	V _{DS} = -15 V, I _D = -3.2 A		4.0		S
Diode Forward Voltage ^a	V _{SD}	I _S = -1.7 A, V _{GS} = 0 V		-0.9	-1.2	V
Dynamic^b						
Total Gate Charge	Q _g	V _{DS} = -10 V, V _{GS} = -10 V, I _D = -3.2 A		15	25	nC
Gate-Source Charge	Q _{gs}			3		
Gate-Drain Charge	Q _{gd}			3.5		
Turn-On Delay Time	t _{d(on)}	V _{DD} = -10 V, R _L = 10 Ω I _D ≅ -1 A, V _{GEN} = -10 V, R _G = 6 Ω		13	40	ns
Rise Time	t _r			13	25	
Turn-Off Delay Time	t _{d(off)}			30	50	
Fall Time	t _f			13	20	
Source-Drain Reverse Recovery Time	t _{rr}	I _F = -1.7 A, di/dt = 100 A/μs		50	100	

Notes

- a. Pulse test; pulse width ≤ 300 μs, duty cycle ≤ 2%.
- b. Guaranteed by design, not subject to production testing.



TYPICAL CHARACTERISTICS (25°C UNLESS NOTED)

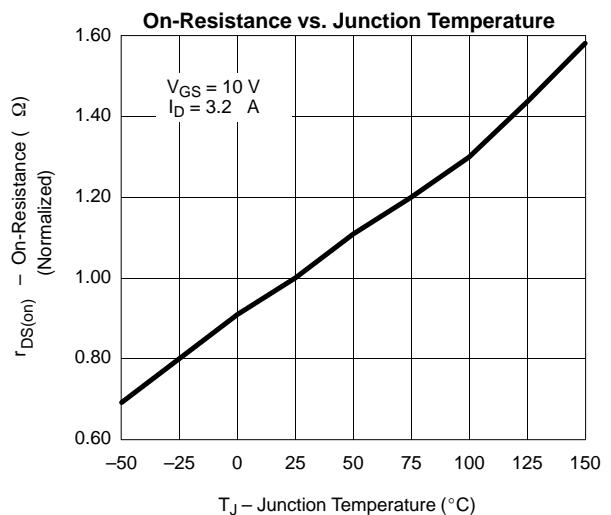
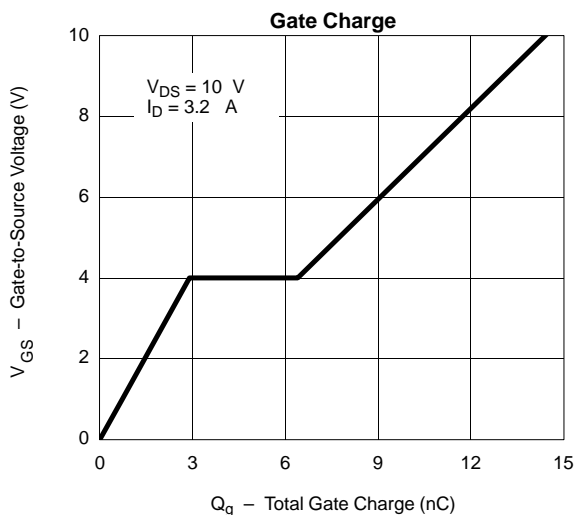
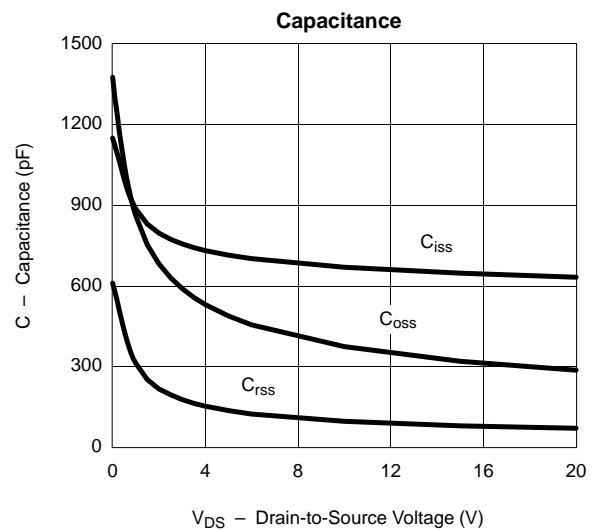
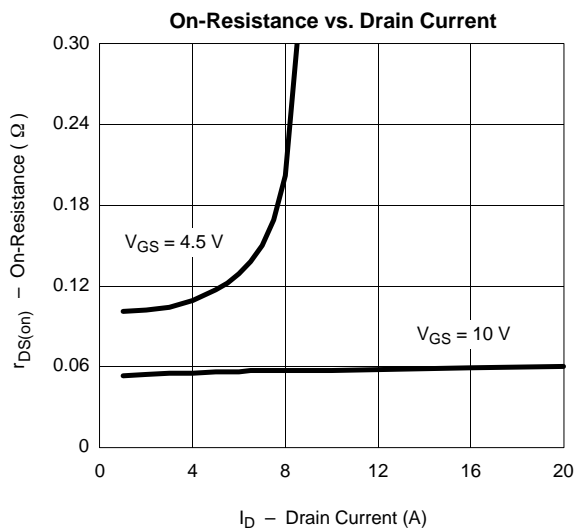
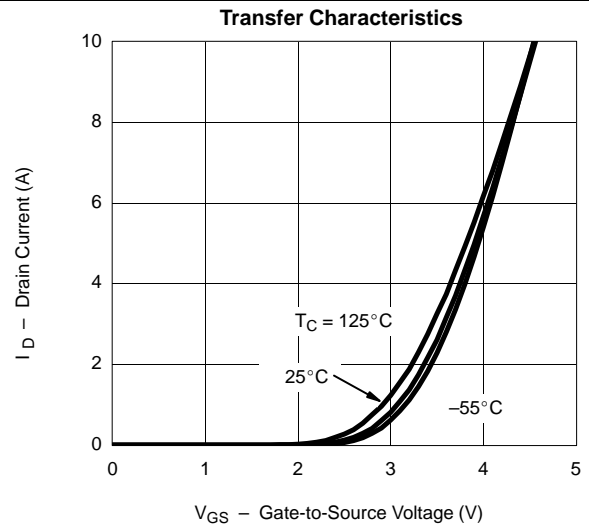
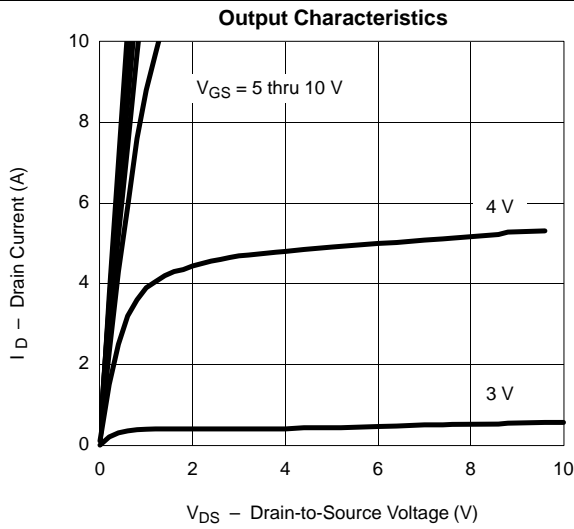

TYPICAL CHARACTERISTICS (25°C UNLESS NOTED)

