

Logic N-Channel MOSFET

Features

- Low $R_{DS(on)}$ (0.0085Ω)@ $V_{GS}=10V$
- Low Gate Charge (Typical 39nC)
- Low C_{rss} (Typical 185pF)
- Improved dv/dt Capability
- 100% Avalanche Tested
- Maximum Junction Temperature Range (175°C)

General Description

This Power MOSFET is produced using SemiWell's advanced planar stripe, DMOS technology. This latest technology has been especially designed to minimize on-state resistance, have a low gate charge with superior switching performance, and rugged avalanche characteristics. This Power MOSFET is well suited for synchronous DC-DC Converters and Power Management in portable and battery operated products.

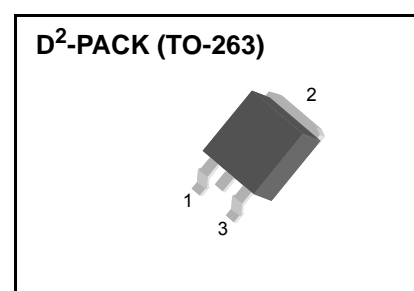
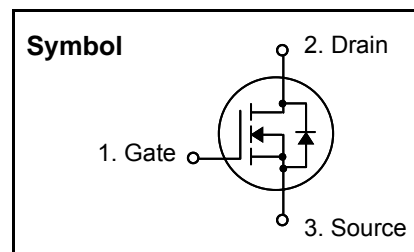

Absolute Maximum Ratings

Symbol	Parameter	Value	Units
V_{DSS}	Drain to Source Voltage	30	V
I_D	Continuous Drain Current(@ $T_C = 25^\circ C$) (Note 6)	95	A
	Continuous Drain Current(@ $T_C = 100^\circ C$)	67.3	A
I_{DM}	Drain Current Pulsed (Note 1)	380	A
V_{GS}	Gate to Source Voltage	± 20	V
E_{AS}	Single Pulsed Avalanche Energy (Note 2)	450	mJ
dv/dt	Peak Diode Recovery dv/dt (Note 3)	7.0	V/ns
P_D	Total Power Dissipation(@ $T_A = 25^\circ C$) *	3.75	W
	Total Power Dissipation(@ $T_C = 25^\circ C$)	150	W
	Derating Factor above $25^\circ C$	1.0	W/°C
T_{STG}, T_J	Operating Junction Temperature & Storage Temperature	- 55 ~ 175	°C
T_L	Maximum Lead Temperature for soldering purpose, 1/8 from Case for 5 seconds.	300	°C

Thermal Characteristics

Symbol	Parameter	Value			Units
		Min.	Typ.	Max.	
$R_{\theta JC}$	Thermal Resistance, Junction-to-Case	-	-	1.0	°C/W
$R_{\theta JA}$	Thermal Resistance, Junction-to-Ambient *	-	-	40	°C/W
$R_{\theta JA}$	Thermal Resistance, Junction-to-Ambient	-	-	62.5	°C/W

* When mounted on the minimum pad size recommended (PCB Mount)

SFB95N03L

Electrical Characteristics ($T_C = 25\text{ }^\circ\text{C}$ unless otherwise noted)

Symbol	Parameter	Test Conditions	Min	Typ	Max	Units
Off Characteristics						
BV_{DSS}	Drain-Source Breakdown Voltage	$V_{GS} = 0V, I_D = 250\mu A$	30	-	-	V
$\Delta BV_{DSS}/\Delta T_J$	Breakdown Voltage Temperature coefficient	$I_D = 250\mu A$, referenced to $25\text{ }^\circ\text{C}$	-	0.023	-	$V/^\circ\text{C}$
I_{DSS}	Drain-Source Leakage Current	$V_{DS} = 30V, V_{GS} = 0V$	-	-	1	μA
		$V_{DS} = 24V, T_C = 150\text{ }^\circ\text{C}$	-	-	10	μA
I_{GSS}	Gate-Source Leakage, Forward	$V_{GS} = 20V, V_{DS} = 0V$	-	-	100	nA
	Gate-Source Leakage, Reverse	$V_{GS} = -20V, V_{DS} = 0V$	-	-	-100	nA
On Characteristics						
$V_{GS(th)}$	Gate Threshold Voltage	$V_{DS} = V_{GS}, I_D = 250\mu A$	1.0	-	3.0	V
$R_{DS(ON)}$	Static Drain-Source On-state Resistance	$V_{GS} = 10V, I_D = 47.5A$ $V_{GS} = 5V, I_D = 47.5A$	-	0.0065 0.0085	0.0085 0.0115	Ω
Dynamic Characteristics						
C_{iss}	Input Capacitance	$V_{GS} = 0V, V_{DS} = 25V, f = 1\text{MHz}$	-	1015	1320	pF
C_{oss}	Output Capacitance		-	845	1110	
C_{rss}	Reverse Transfer Capacitance		-	185	240	
Dynamic Characteristics						
$t_{d(on)}$	Turn-on Delay Time	$V_{DD} = 15V, I_D = 95A, R_G = 50\Omega$ * see fig. 13. (Note 4, 5)	-	45	100	ns
t_r	Rise Time		-	165	340	
$t_{d(off)}$	Turn-off Delay Time		-	70	150	
t_f	Fall Time		-	140	290	
Q_g	Total Gate Charge	$V_{DS} = 24V, V_{GS} = 5V, I_D = 95A$ * see fig. 12. (Note 4, 5)	-	39	51	nC
Q_{gs}	Gate-Source Charge		-	13	-	
Q_{gd}	Gate-Drain Charge(Miller Charge)		-	18	-	

Source-Drain Diode Ratings and Characteristics

Symbol	Parameter	Test Conditions	Min.	Typ.	Max.	Unit.
I_S	Continuous Source Current	Integral Reverse p-n Junction Diode in the MOSFET	-	-	95	A
I_{SM}	Pulsed source Current		-	-	380	
V_{SD}	Diode Forward Voltage	$I_S = 95A, V_{GS} = 0V$	-	-	1.5	V
t_{rr}	Reverse Recovery Time	$I_S = 95A, V_{GS} = 0V, di_F/dt = 100A/\mu s$	-	55	-	ns
Q_{rr}	Reverse Recovery Charge		-	65	-	nC

* NOTES

1. Repeatability rating : pulse width limited by junction temperature
2. $L = 50\text{ }\mu H, I_{AS} = 95A, V_{DD} = 15V, R_G = 0\Omega$, Starting $T_J = 25\text{ }^\circ\text{C}$
3. $I_{SD} \leq 95A, di/dt \leq 300A/\mu s, V_{DD} \leq BV_{DSS}$, Starting $T_J = 25\text{ }^\circ\text{C}$
4. Pulse Test : Pulse Width $\leq 300\mu s$, Duty Cycle $\leq 2\%$
5. Essentially independent of operating temperature.
6. Continuous Drain current calculated by maximum junction temperature ; limited by package



Fig 1. On-State Characteristics

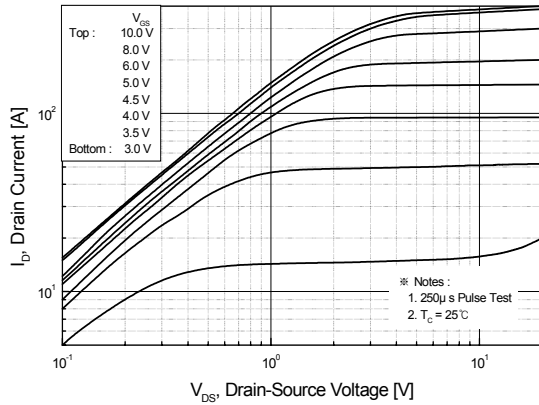

Fig 2. Transfer Characteristics

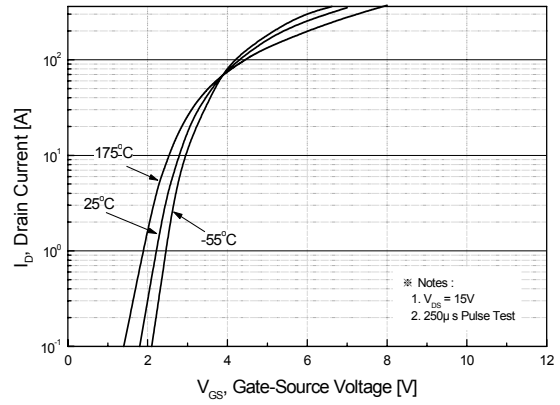

Fig 3. On Resistance Variation vs. Drain Current and Gate Voltage

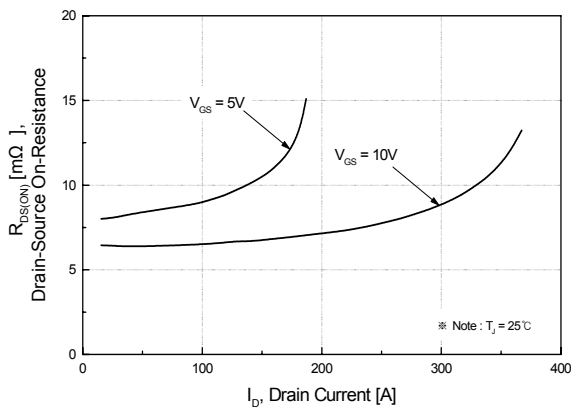

Fig 4. On State Current vs. Allowable Case Temperature

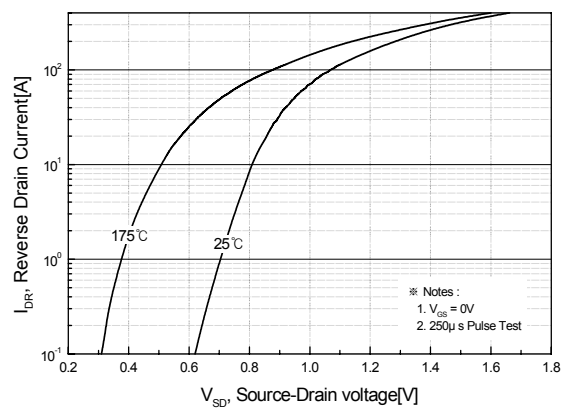

Fig 5. Capacitance Characteristics

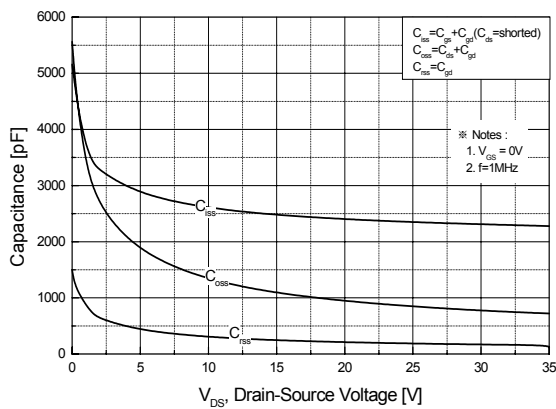
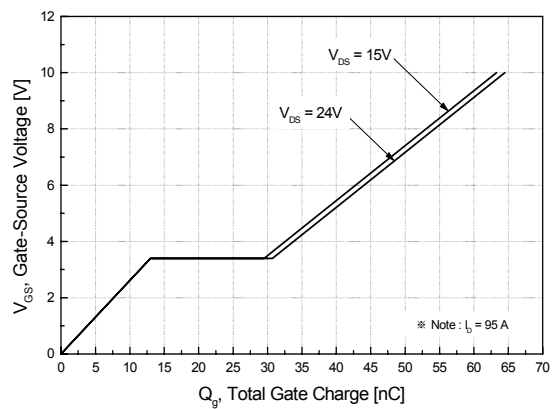

Fig 6. Gate Charge Characteristics



SFB95N03L

Fig 7. Breakdown Voltage Variation vs. Junction Temperature

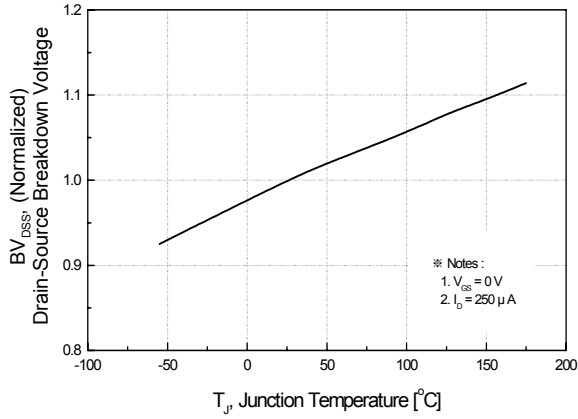

Fig 8. On-Resistance Variation vs. Junction Temperature

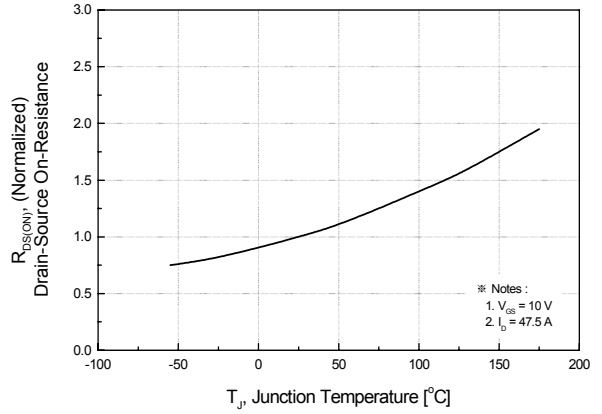

Fig 9. Maximum Safe Operating Area

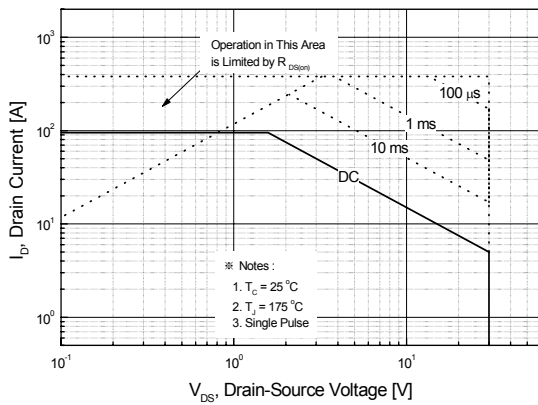

Fig 10. Maximum Drain Current vs. Case Temperature

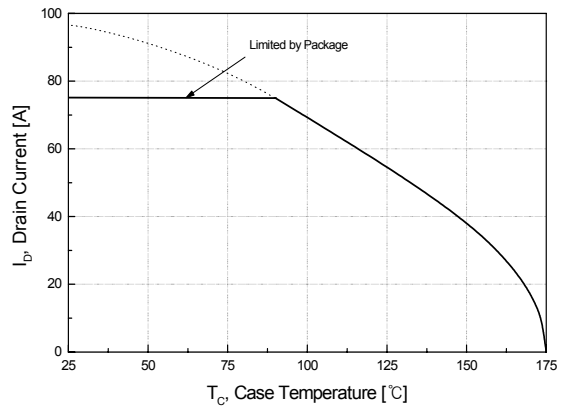

Fig 11. Transient Thermal Response Curve

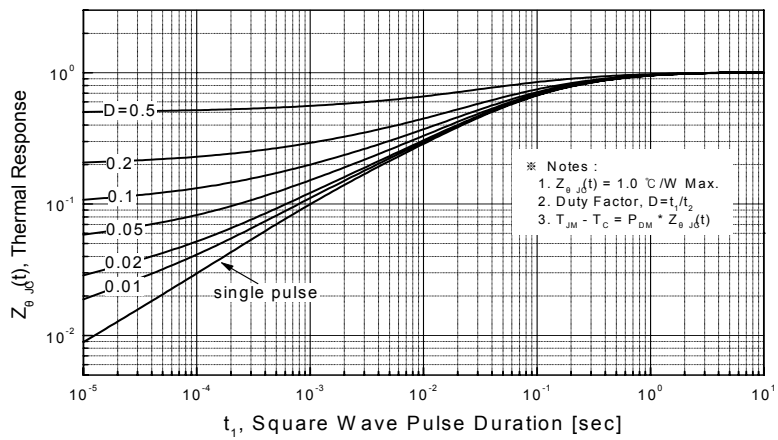

Fig. 12. Gate Charge Test Circuit & Waveforms

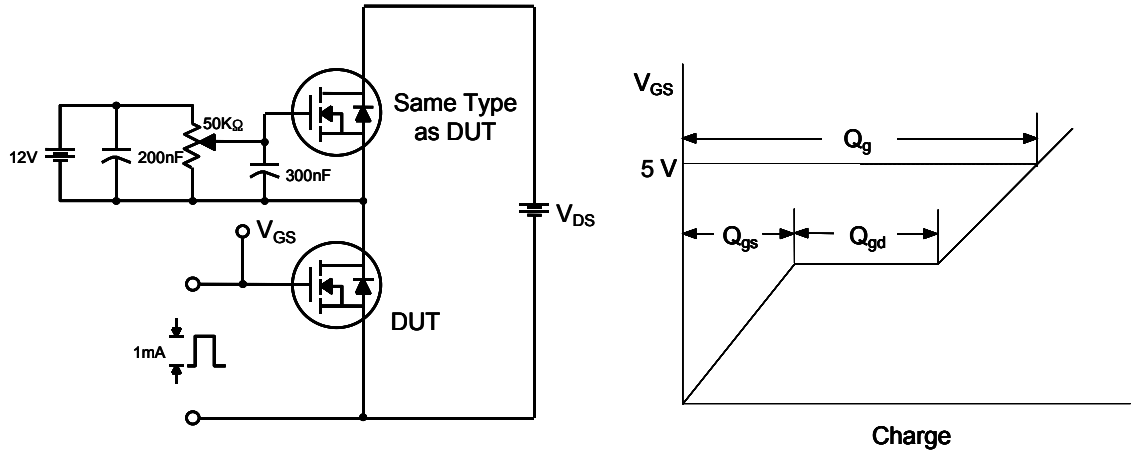

Fig. 13. Switching Time Test Circuit & Waveforms

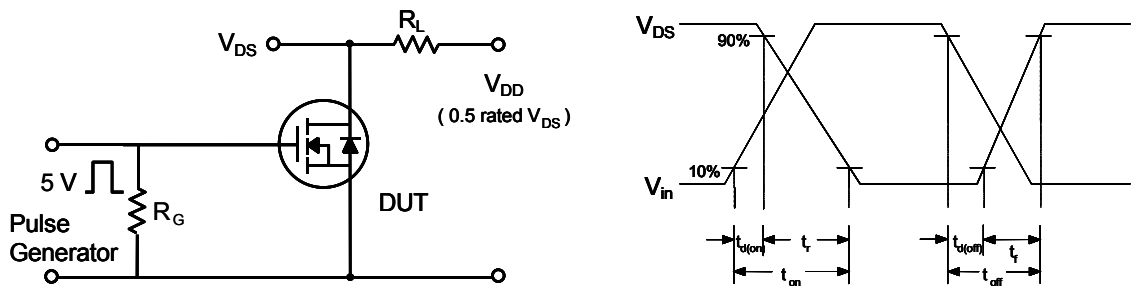
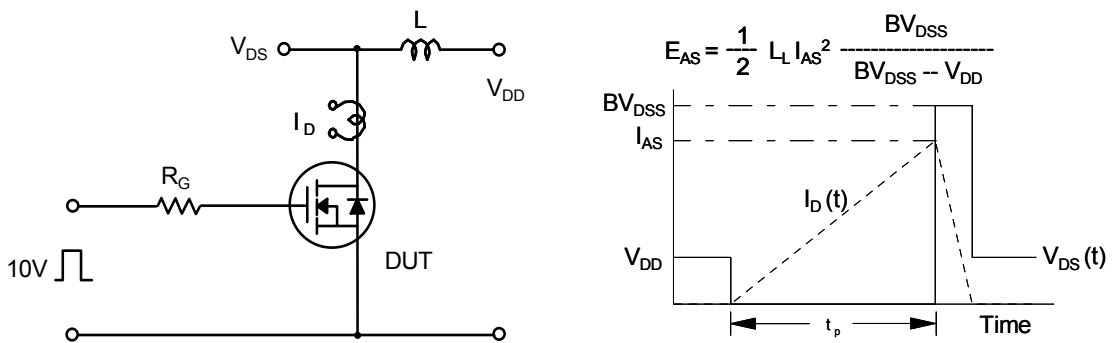
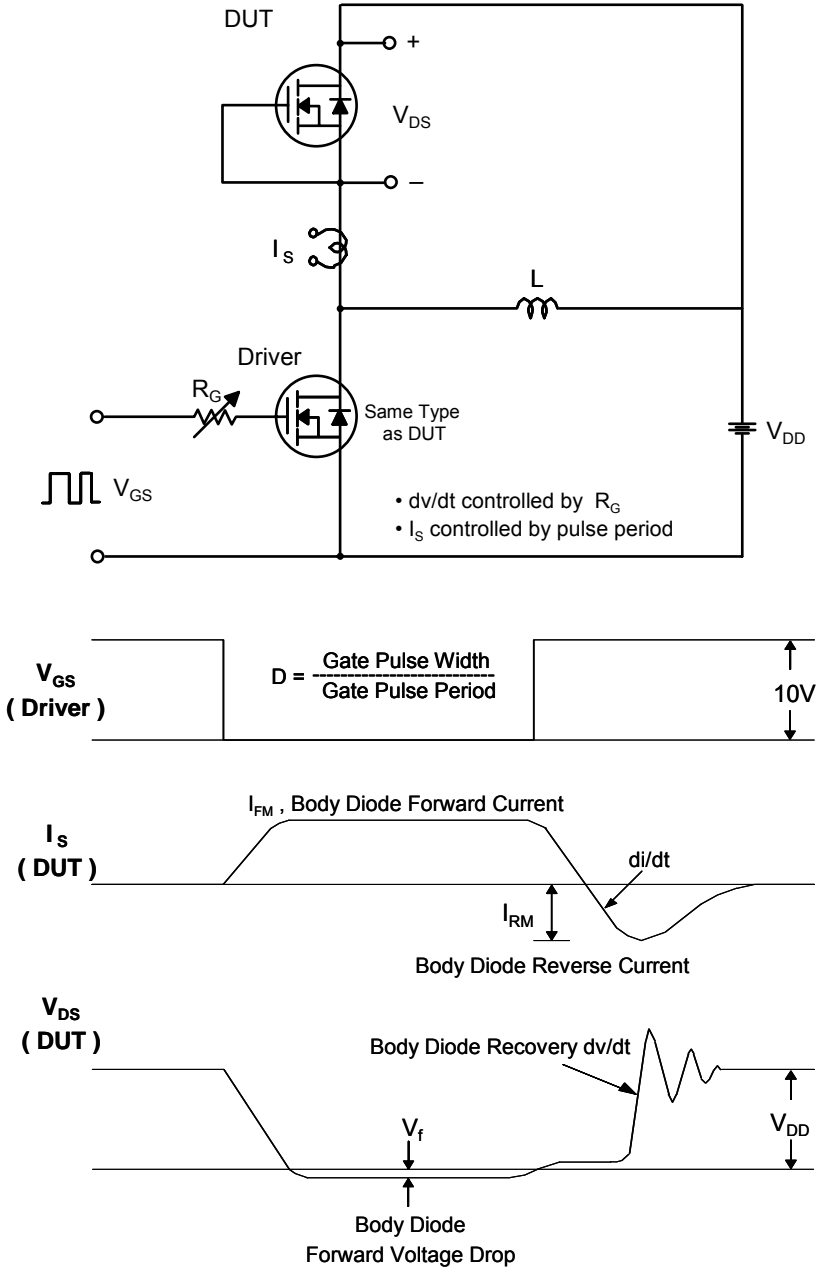

Fig. 14. Unclamped Inductive Switching Test Circuit & Waveforms



SFB95N03L

Fig. 15. Peak Diode Recovery dv/dt Test Circuit & Waveforms



SFB95N03L

TO-263(D²-PAK) Package Dimension

Dim.	mm			Inch		
	Min.	Typ.	Max.	Min.	Typ.	Max.
A	9.8	10	10.2	0.386	0.394	0.402
B	7.9	8	8.1	0.311	0.315	0.319
C	11.2	11.8	12.4	0.441	0.465	0.488
D	4.3	4.5	4.7	0.169	0.177	0.185
E	1.25	1.3	1.4	0.049	0.051	0.055
F	1.0	1.2	1.4	0.039	0.047	0.055
G		2.54			0.1	
H		2.54			0.1	
I	2.24	2.54	2.84	0.088	0.1	0.112
J	2.2	2.4	2.6	0.087	0.094	0.102
K	0.45	0.5	0.6	0.018	0.02	0.024
L	0.7	0.8	0.9	0.028	0.031	0.035
ϕ		1.57			0.06	

