

Features

- Milky diffusion lens type
- $\phi 5\text{mm}$ (T-13/4) all plastic mold type
- Radiation color (Amber, Y-Green)
- Low power consumption

Outline Dimensions

unit : mm

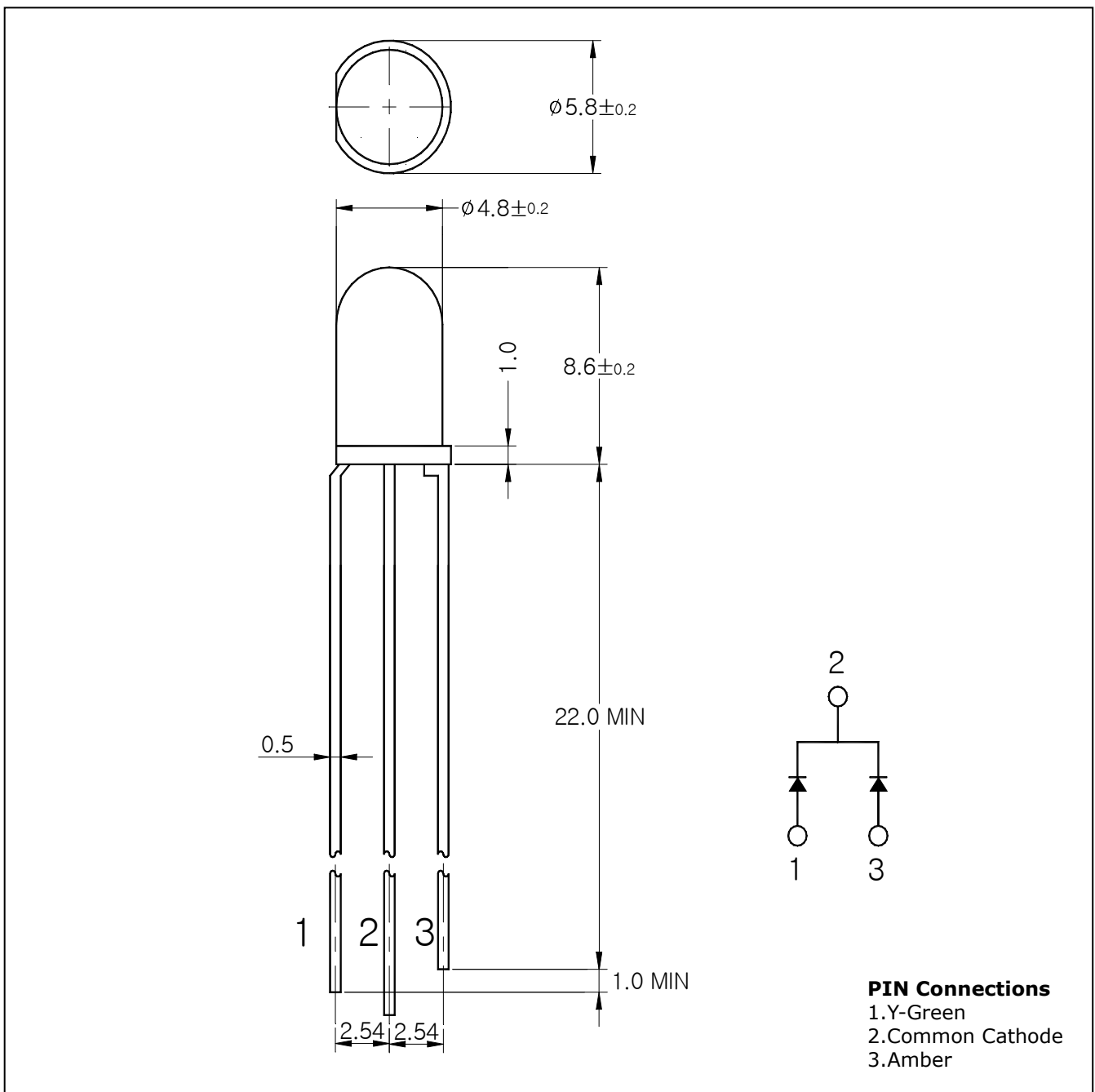

Absolute maximum ratings

Characteristic	Symbol	Ratings	Unit
Power Dissipation	P_D	85	mW
Forward Current	I_F	30	mA
*1Peak Forward Current	I_{FP}	50	mA
Reverse Voltage	V_R	4	V
Operating Temperature	T_{opr}	-25 ~ 85	°C
Storage Temperature	T_{stg}	-30 ~ 100	°C
*2Soldering Temperature	T_{sol}	260°C for 5 seconds	

*1.Duty ratio = 1/16, Pulse width = 0.1ms

*2.Keep the distance more than 2.0mm from PCB to the bottom of LED package

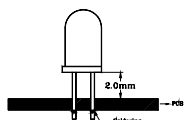

Electrical Characteristics

Characteristic	Symbol	Test Condition	Min.	Typ.	Max.	Unit	
Forward Voltage	V_F	$I_F= 20mA$	Y-Green	-	2.1	2.5	V
			Amber	-	2.0	2.5	
Luminous Intensity	I_V	$I_F= 20mA$	Y-Green	5.5	-	-	mcd
			Amber	5.5	-	-	
Peak Wavelength	λ_p	$I_F= 20mA$	Y-Green	-	570	-	nm
			Amber	-	630	-	
Spectrum Bandwidth	$\Delta \lambda$	$I_F= 20mA$	Y-Green	-	35	-	nm
			Amber	-	30	-	
Reverse Current	I_R	$V_R=4V$	-	-	10	uA	
*3Half angle	$\theta_{1/2}$	$I_F= 20mA$	-	± 20	-	deg	

*3. $\theta_{1/2}$ is the off-axis angle where the luminous intensity is 1/2 the peak intensity

Characteristic Diagrams

Fig. 1 $I_F - V_F$

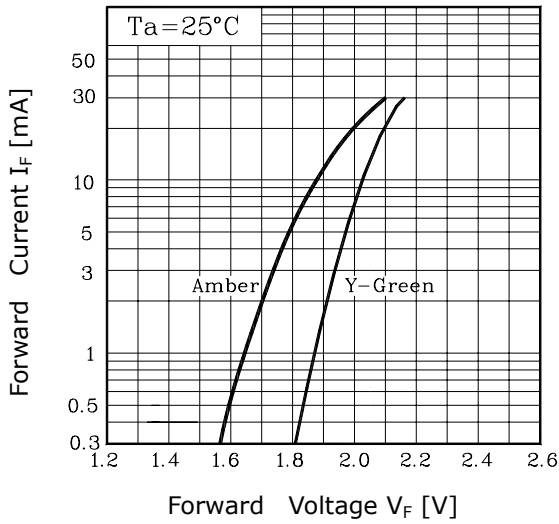

Fig. 2 $I_V - I_F$

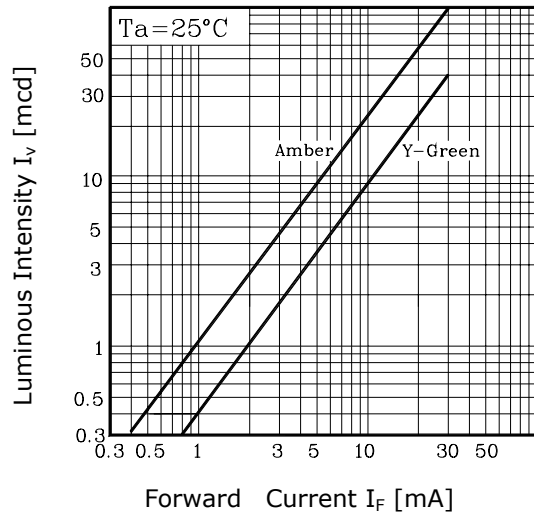

Fig. 3 $I_F - T_a$

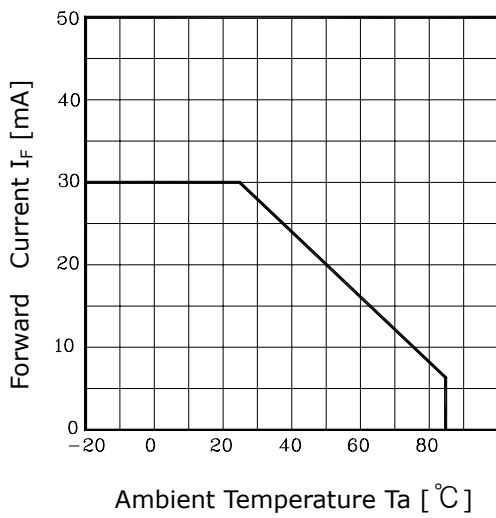

Fig. 4 Spectrum Distribution

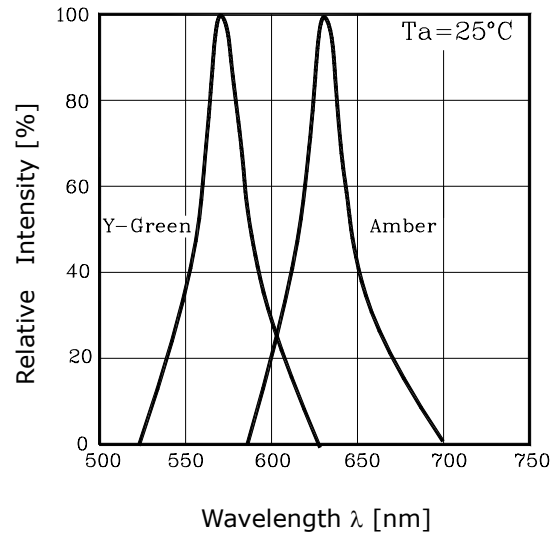
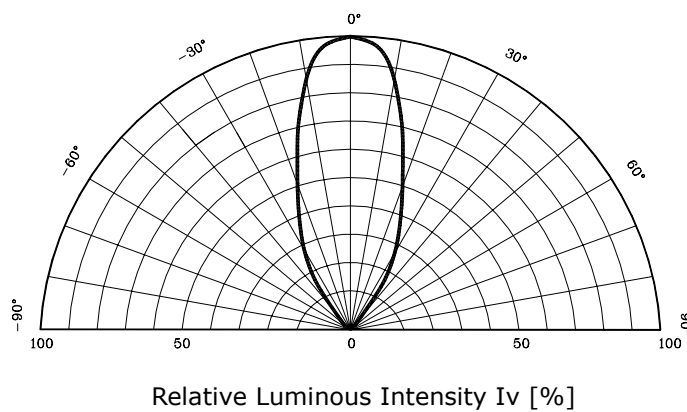

Fig. 5 Radiation Diagram



These AUK products are intended for usage in general electronic equipments(Office and communication equipment, measuring equipment, domestic electrification, etc.).

Please make sure that you consult with us before you use these AUK products in equipments which require high quality and/or reliability, and in equipments which could have major impact to the welfare of human life(atomic energy control, airplane, spaceship, traffic signal, combustion central, all types of safety device, etc.).

AUK cannot accept liability to any damage which may occur in case these AUK products were used in the mentioned equipments without prior consultation with AUK.