

Typical Applications

- Broadband Gain Blocks
- Final PA for Low-Power Applications
- IF or RF Buffer Amplifiers
- Driver Stage for Power Amplifiers
- Oscillator Loop Amplifiers

Product Description

The RF2322 is a general purpose, low-cost silicon amplifier designed for operation from a 3V supply. The circuit configuration with resistive feedback allows for broadband cascadable amplification. Capacitive compensation extends the bandwidth of the amplifier and input stage design optimizes noise figure. The device is unconditionally stable and internally matched to 50Ω. The only external components required for specified performance are bypass and DC blocking capacitors (as shown in application schematic). The RF2322 is available in a very small industry-standard SOT-23 5-lead surface mount package, enabling compact designs which conserve board space.

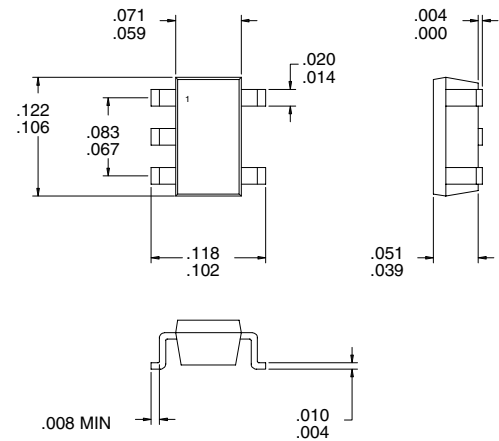

Optimum Technology Matching® Applied

- | | | |
|--|-----------------------------------|--------------------------------------|
| <input checked="" type="checkbox"/> Si BJT | <input type="checkbox"/> GaAs HBT | <input type="checkbox"/> GaAs MESFET |
| <input type="checkbox"/> Si Bi-CMOS | <input type="checkbox"/> SiGe HBT | <input type="checkbox"/> Si CMOS |

Package Style: SOT-23-5

Features

- DC to >2000MHz Operation
- 2.7V to 3.3V Single Supply
- +3dBm Output IP3
- 19dB Gain at 900MHz
- 12dB Gain at 1900MHz
- High Isolation (38dB at 900MHz)

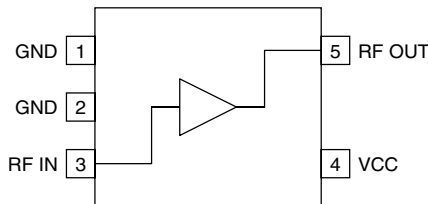

Functional Block Diagram

Ordering Information

- | | |
|-------------|----------------------------------|
| RF2322 | 3V General Purpose Amplifier |
| RF2322 PCBA | Fully Assembled Evaluation Board |

RF Micro Devices, Inc.
7625 Thorndike Road
Greensboro, NC 27409, USA

Tel (336) 664 1233
Fax (336) 664 0454
<http://www.rfmd.com>

Absolute Maximum Ratings

Parameter	Rating	Unit
Supply Voltage	4.0	V
Operating Ambient Temperature	-40 to +85	°C
Storage Temperature	-40 to +150	°C



Caution! ESD sensitive device.

RF Micro Devices believes the furnished information is correct and accurate at the time of this printing. However, RF Micro Devices reserves the right to make changes to its products without notice. RF Micro Devices does not assume responsibility for the use of the described product(s).

4
GENERAL PURPOSE
AMPLIFIERS

Parameter	Specification			Unit	Condition
	Min.	Typ.	Max.		
Overall					
Frequency Range		DC to >2000		MHz	T=27 °C, V _{CC} =3.0V
100MHz Performance					T=27 °C, V _{CC} =3.0V
Gain		20		dB	
Noise Figure		3.2		dB	
Output IP3		4		dBm	
Output P _{1dB}		-8		dBm	
Input Return Loss		19		dB	
Output Return Loss		11		dB	
Isolation		55		dB	
500MHz Performance					T=27 °C, V _{CC} =3.0V
Gain		20		dB	
Noise Figure		3.4		dB	
Output IP3		4		dBm	
Output P _{1dB}		-8		dBm	
Input Return Loss		18		dB	
Output Return Loss		9		dB	
Isolation		45		dB	
900MHz Performance					T=27 °C, V _{CC} =3.0V
Gain		19		dB	
Noise Figure		3.3		dB	
Output IP3		3		dBm	
Output P _{1dB}		-7		dBm	
Input Return Loss		13		dB	
Output Return Loss		8		dB	
Isolation		38		dB	
1000MHz Performance					T=27 °C, V _{CC} =3.0V
Gain		19		dB	
Noise Figure		3.2		dB	
Output IP3		3		dBm	
Output P _{1dB}		-8		dBm	
Input Return Loss		12		dB	
Output Return Loss		8		dB	
Isolation		35		dB	
2000MHz Performance					T=27 °C, V _{CC} =3.0V
Gain		12		dB	
Noise Figure		4.0		dB	
Output IP3		2		dBm	
Output P _{1dB}		-8		dBm	
Input Return Loss		11		dB	
Output Return Loss		15		dB	
Isolation		26		dB	
Power Supply					
Operating Voltage		3.0±10%		V	V _{CC} =3.0V
Operating Current		7.5		mA	

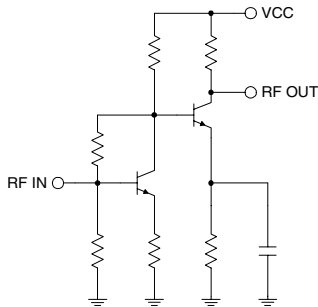
Pin	Function	Description	Interface Schematic
1	GND	Ground connection. Keep traces physically short and connect immediately to ground plane for best performance.	
2	GND	Same as pin 1.	
3	RF IN	RF input pin. This pin is not internally DC blocked and thus requires an external blocking capacitor suitable for the frequency of operation. The input impedance of this pin is internally matched to 50Ω using resistive feedback.	
4	VCC	Supply connection. This pin should be bypassed with a suitable capacitor(s).	
5	RF OUT	RF output and bias pin. The output impedance of this pin is internally matched to 50Ω using resistive feedback. Because DC biasing is present on this pin, a DC blocking capacitor should be used in most applications (see application schematic).	See pin 3 schematic.

4
GENERAL PURPOSE
AMPLIFIERS

Application Schematic

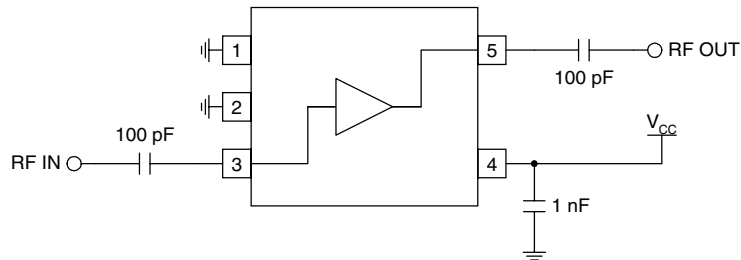

Evaluation Board Schematic

(Download [Bill of Materials](http://www.rfmd.com) from www.rfmd.com.)

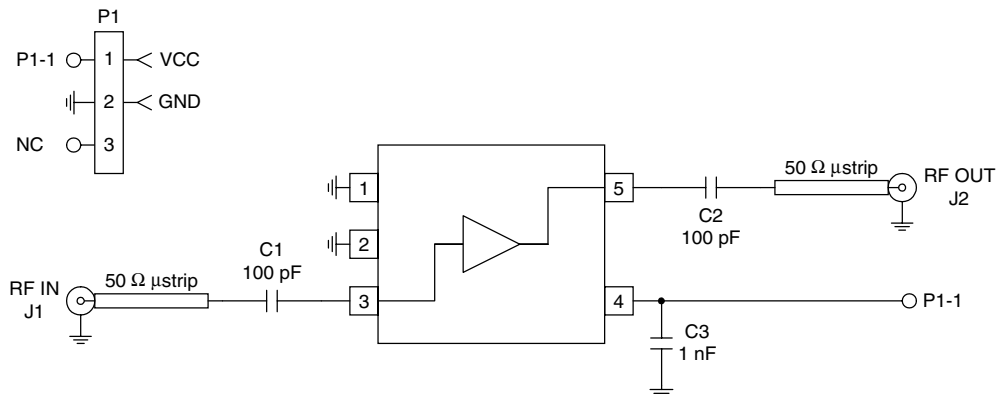

Evaluation Board Layout 1" x 1"

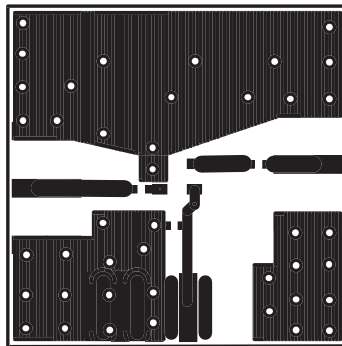
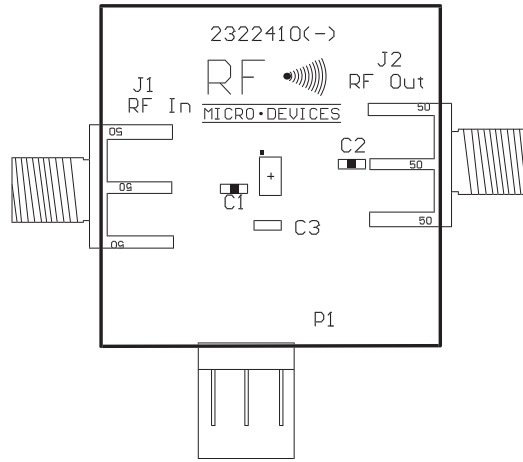

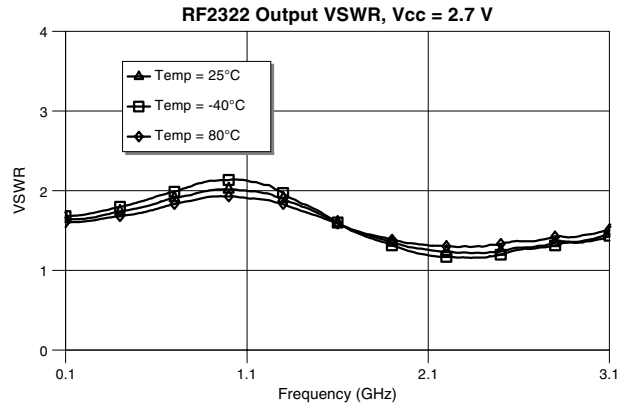
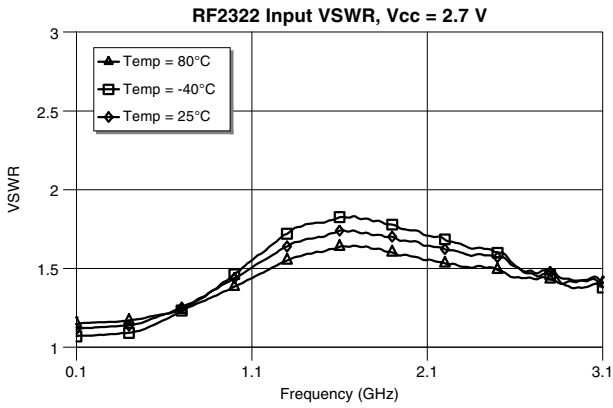
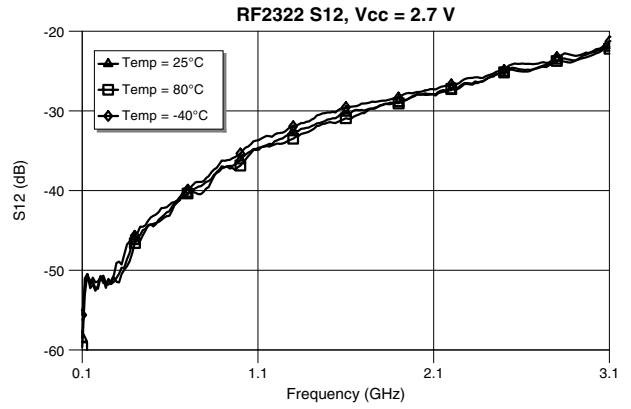
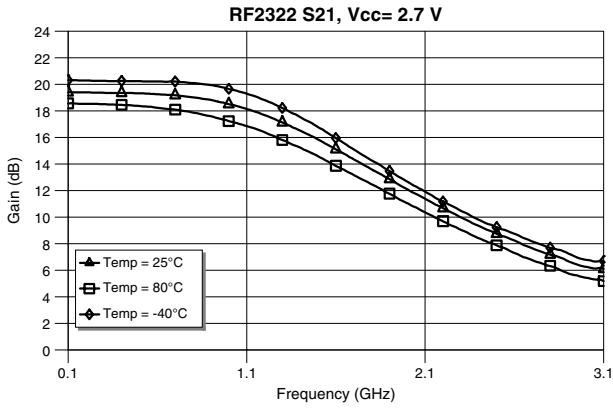

RF2322 S11, Vcc = 2.7 V, Temp = 25°C

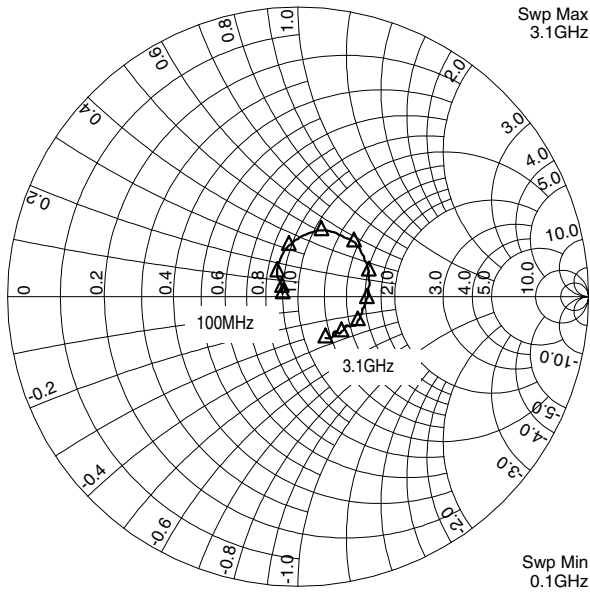

RF2322 S22, Vcc = 2.7 V, Temp = 25°C

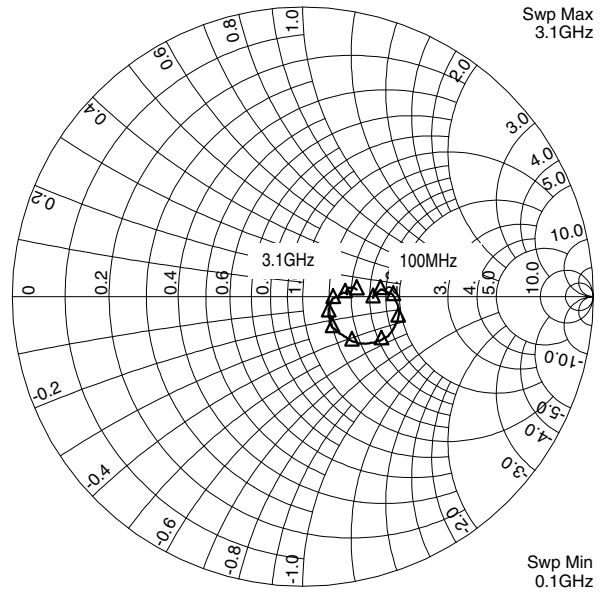

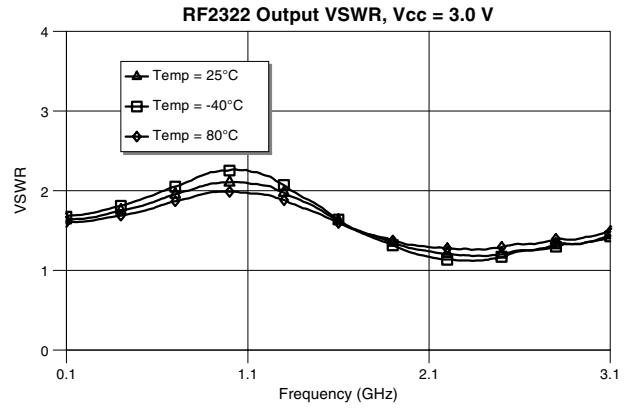
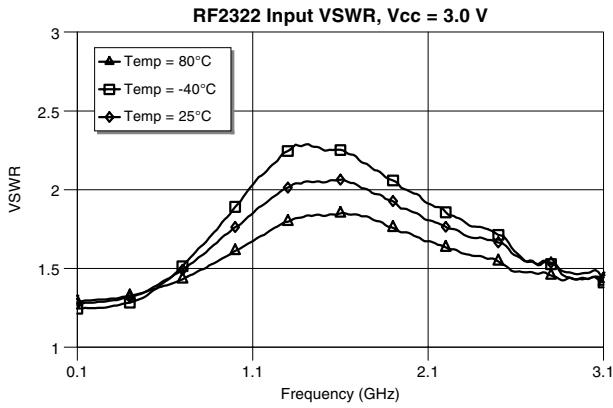
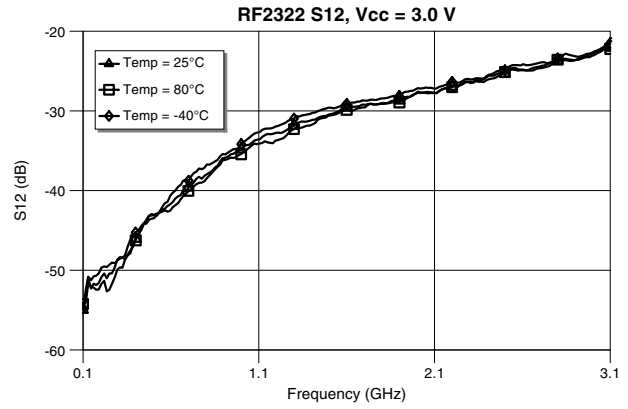
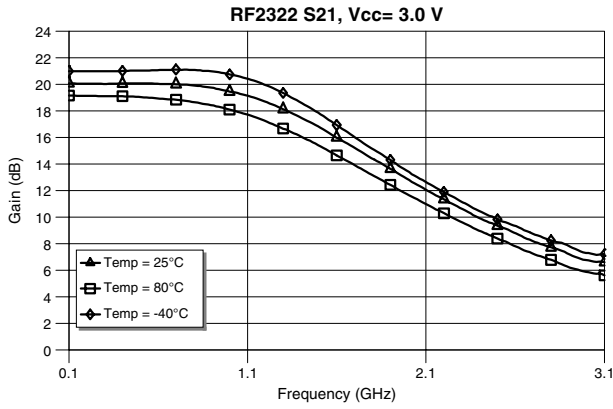

RF2322 S11, Vcc = 3.0 V, Temp = 25°C

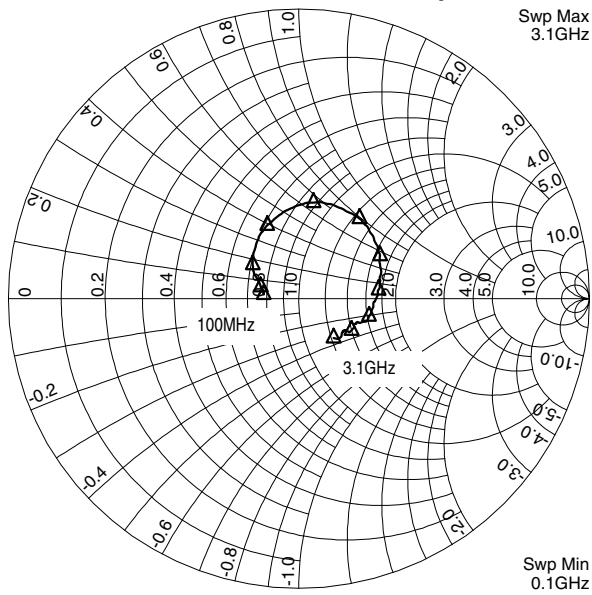

RF2322 S22, Vcc = 3.0 V, Temp = 25°C

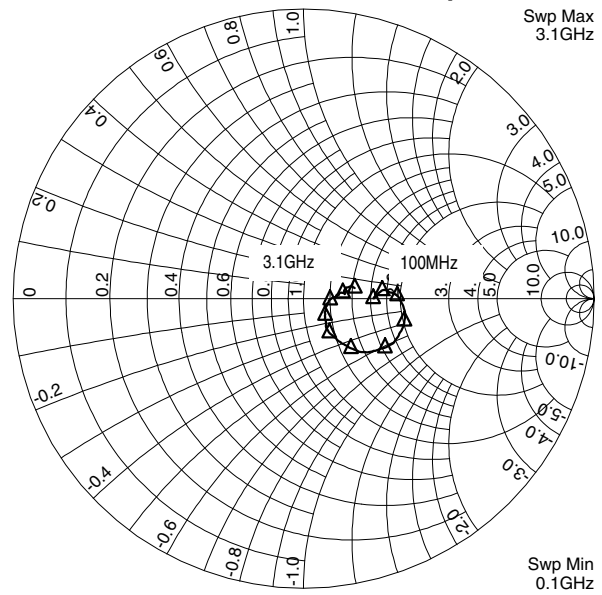

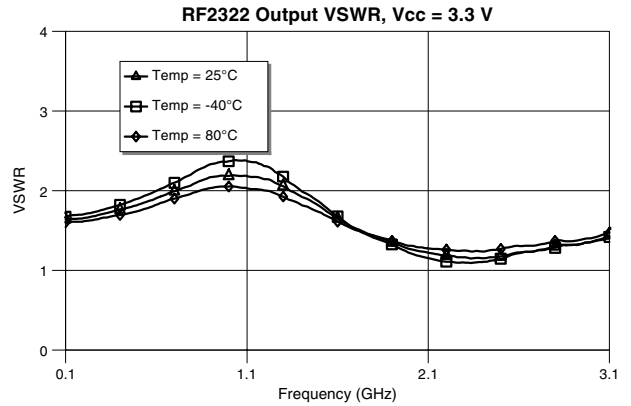
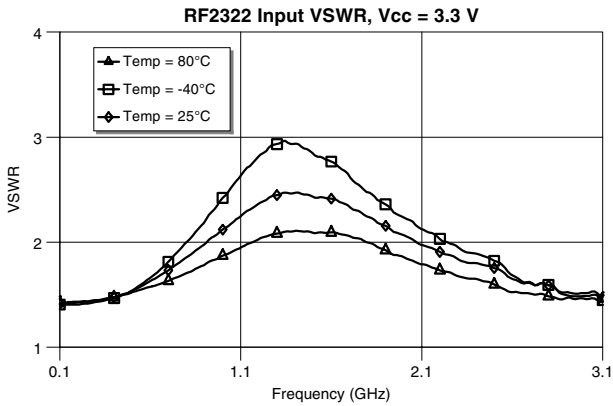
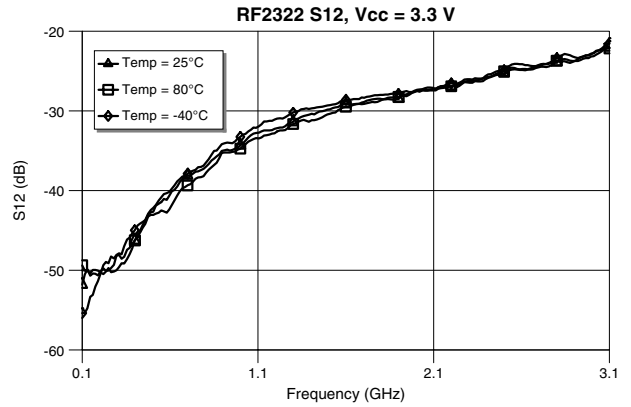
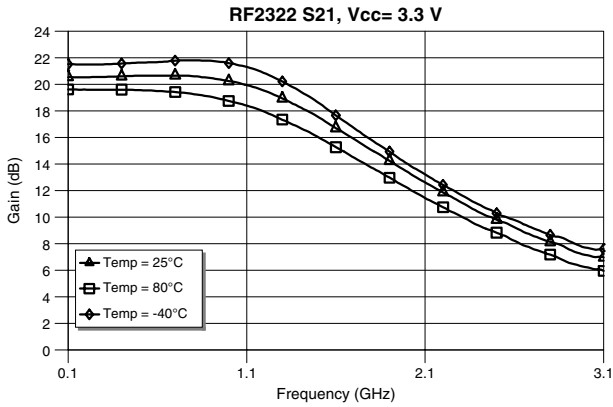

RF2322 S11, Vcc = 3.3 V, Temp = 25°C

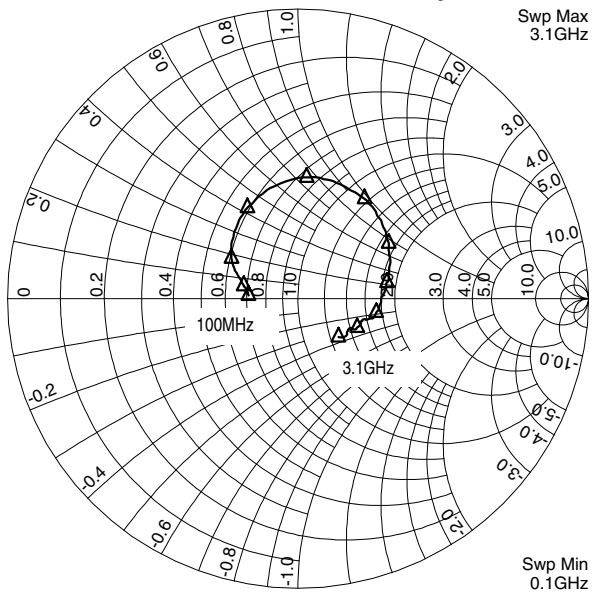

RF2322 S22, Vcc = 3.3 V, Temp = 25°C

