

CIRCUIT

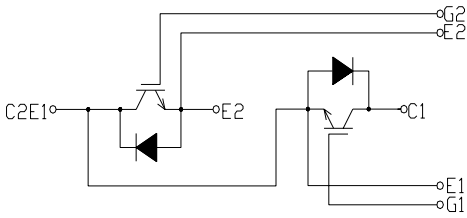

OUTLINE DRAWING

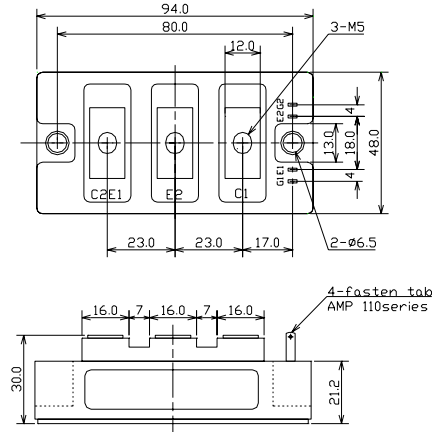

4-fasten- tab No 110

Dimension(mm)

Approximate Weight : 320g

MAXMUM RATINGS (Tc=25°C)

Item	Symbol	PDMB150B12C2	Unit
Collector-Emitter Voltage	V_{CES}	1200	V
Gate - Emitter Voltage	V_{GES}	+/- 20	V
Collector Current	DC	I_C	150
	1 ms	I_C	300
Collector Power Dissipation	P_C	730	W
Junction Temperature Range	T_j	-40 to +150	°C
Storage Temperature Range	T_{sg}	-40 to +125	°C
Isolation Voltage (Terminal to Base AC, 1 min.)	V_{ISO}	2500	V
Mounting Torque	Module Base to Heat sink	F_{TOR}	2.04
	Bus Bar to Main Terminals		

ELECTRICAL CHARACTERISTICS (Tc=25°C)

Characteristic	Symbol	Test Condition	Min.	Typ.	Max.	Unit
Collector-Emitter Cut-Off Current	I_{CES}	$V_{CE}=1200V, V_{GE}=0V$	-	-	3.0	mA
Gate-Emitter Leakage Current	I_{GES}	$V_{GE}=\pm 20V, V_{CE}=0V$	-	-	1.0	μA
Collector-Emitter Saturation Voltage	$V_{CE(sat)}$	$I_C=150A, V_{GE}=15V$	-	1.9	2.4	V
Gate-Emitter Threshold Voltage	$V_{GE(th)}$	$V_{CE}=5V, I_C=150mA$	4.0	-	8.0	V
Input Capacitance	C_{ies}	$V_{CE}=10V, V_{GE}=0V, f=1MHz$	-	12,600	-	pF
Switching Time	Rise Time	$V_{CC}=600V$ $R_L=4\text{ ohm}$ $R_G=3.6\text{ ohm}$ $V_{GE}=\pm 15V$	-	0.25	0.45	μs
	Turn-on Time		-	0.40	0.7	
	Fall Time		-	0.25	0.35	
	Turn-off Time		-	0.80	1.10	

FREE WHEELING DIODES RATINGS & CHARACTERISTICS (Tc=25°C)

Item	Symbol	Rated Value	Unit
Forward Current	DC	I_F	150
	1 ms	I_{FM}	300

Characteristic	Symbol	Test Condition	Min.	Typ.	Max.	Unit
Peak Forward Voltage	V_F	$I_F=150A, V_{GE}=0V$	-	1.9	2.4	V
Reverse Recovery Time	t_{rr}	$I_F=150A, V_{GE}=-10V, di/dt=300A/\mu s$	-	0.2	0.3	μs

THERMAL CHARACTERISTICS

Characteristic	Symbol	Test Condition	Min.	Typ.	Max.	Unit
Thermal Impedance	IGBT	$R_{th(j-c)}$ Junction to Case	-	-	0.16	°C/W
	DIODE		-	-	0.32	

Fig.1- Output Characteristics (Typical)

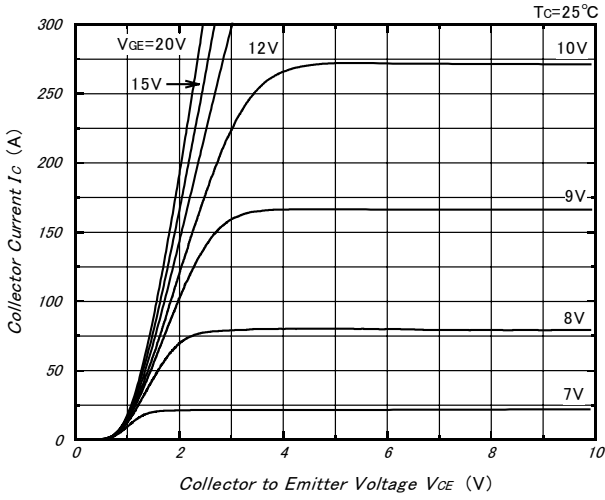

Fig.2- Collector to Emitter On Voltage vs. Gate to Emitter Voltage (Typical)

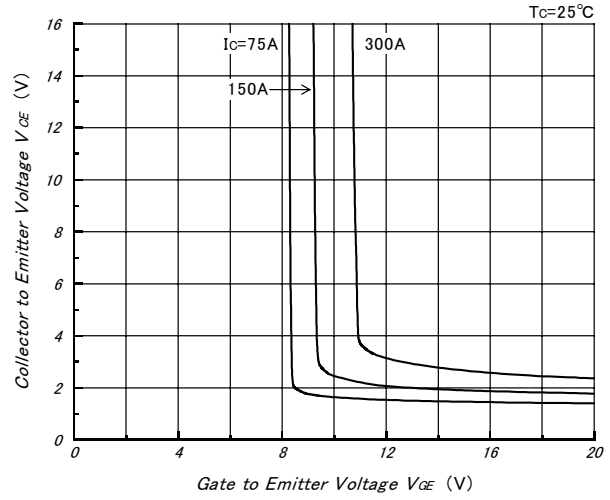

Fig.3- Collector to Emitter On Voltage vs. Gate to Emitter Voltage (Typical)

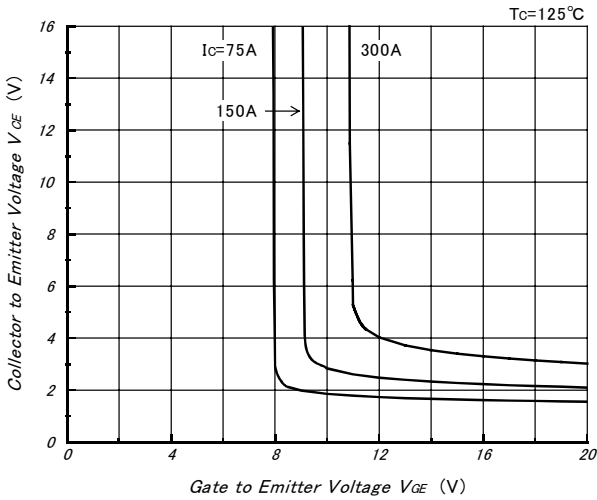

Fig.4- Gate Charge vs. Collector to Emitter Voltage (Typical)

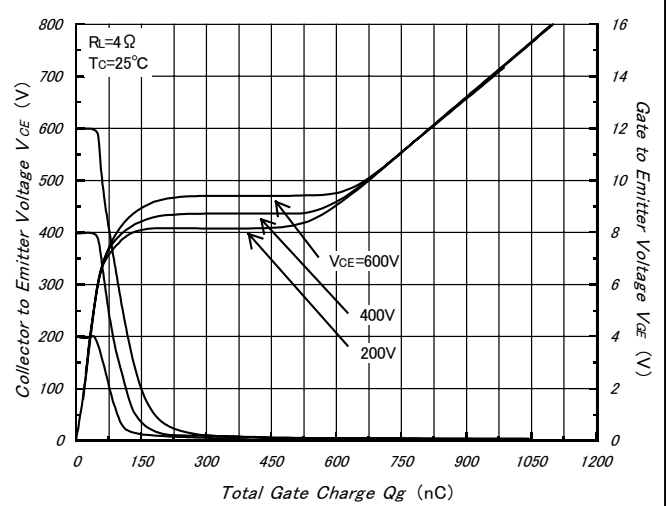

Fig.5- Capacitance vs. Collector to Emitter Voltage (Typical)

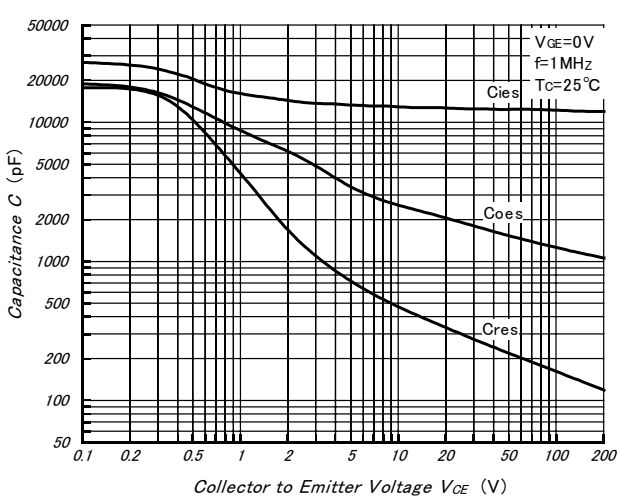

Fig.6- Collector Current vs. Switching Time (Typical)

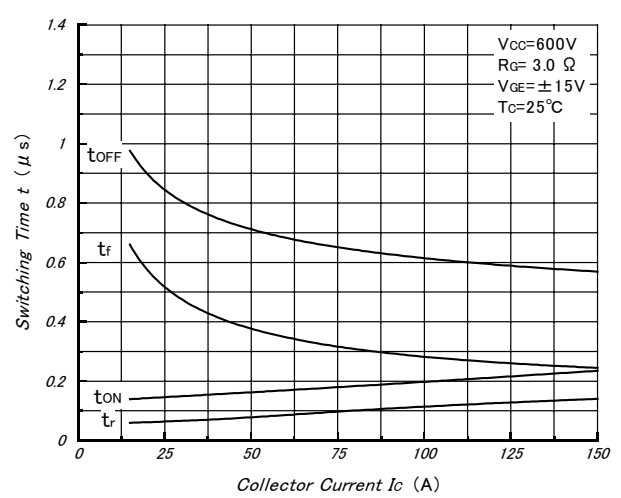

Fig.7- Series Gate Impedance vs. Switching Time (Typical)

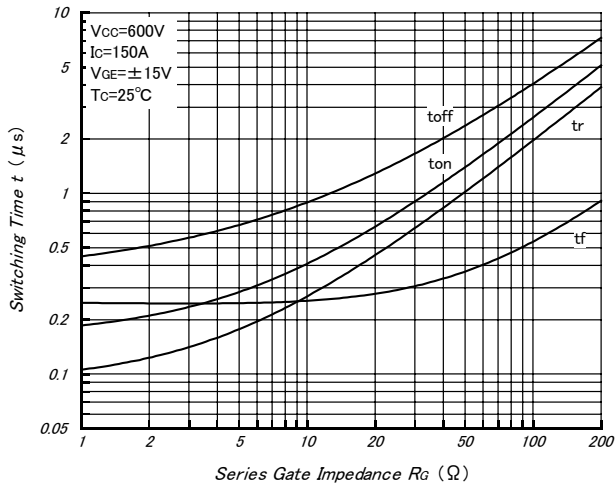

Fig.8- Forward Characteristics of Free Wheeling Diode (Typical)

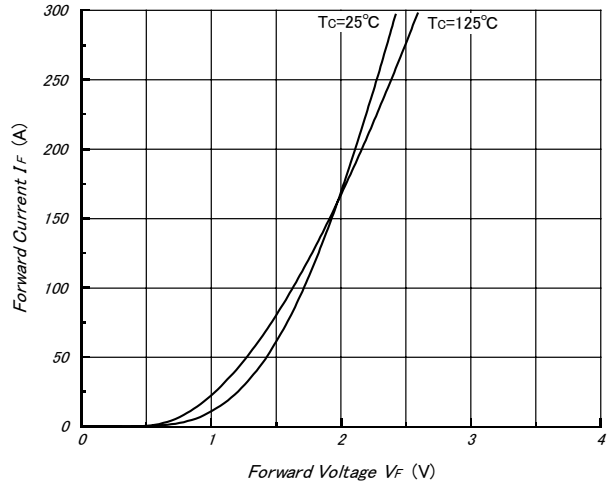

Fig.9- Reverse Recovery Characteristics (Typical)

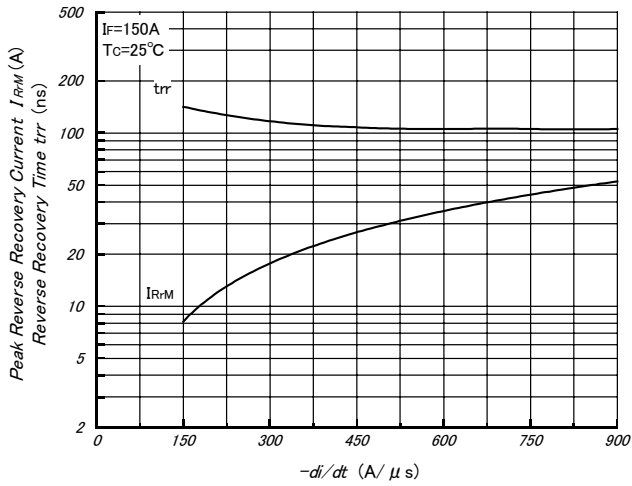

Fig.10- Reverse Bias Safe Operating Area

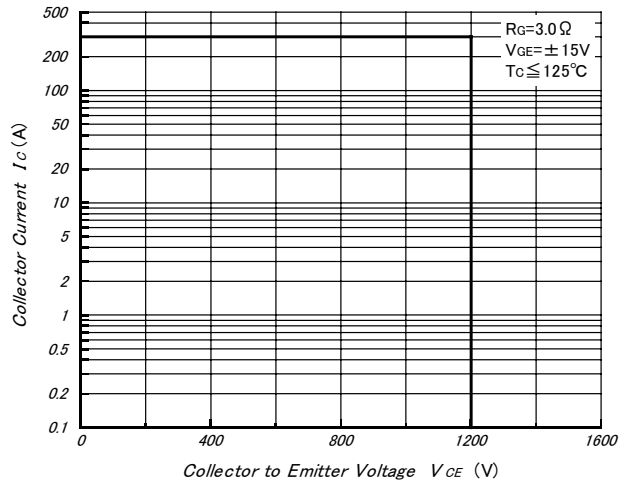

Fig.11- Transient Thermal Impedance

