

NTR1P02LT1

Power MOSFET

**-20 V, -1.3 A, P-Channel
SOT-23 Package**

These miniature surface mount MOSFETs low $R_{DS(on)}$ assure minimal power loss and conserve energy, making these devices ideal for use in space sensitive power management circuitry. Typical applications are DC-DC converters and power management in portable and battery-powered products such as computers, printers, PCMCIA cards, cellular and cordless telephones.

Features

- Low $R_{DS(on)}$ Provides Higher Efficiency and Extends Battery Life
- Miniature SOT-23 Surface Mount Package Saves Board Space
- Pb-Free Packages are Available

MAXIMUM RATINGS ($T_J = 25^\circ\text{C}$ unless otherwise noted)

Rating	Symbol	Value	Unit
Drain-to-Source Voltage	V_{DS}	-20	V
Gate-to-Source Voltage - Continuous	V_{GS}	± 12	V
Drain Current - Continuous @ $T_A = 25^\circ\text{C}$ - Pulsed Drain Current ($t_p \leq 10 \mu\text{s}$)	I_D I_{DM}	-1.3 -4.0	A A
Total Power Dissipation @ $T_A = 25^\circ\text{C}$	P_D	400	mW
Operating and Storage Temperature Range	T_J, T_{stg}	-55 to 150	$^\circ\text{C}$
Thermal Resistance - Junction-to-Ambient	$R_{\theta JA}$	300	$^\circ\text{C/W}$
Maximum Lead Temperature for Soldering Purposes, (1/8" from case for 10 s)	T_L	260	$^\circ\text{C}$

Stresses exceeding Maximum Ratings may damage the device. Maximum Ratings are stress ratings only. Functional operation above the Recommended Operating Conditions is not implied. Extended exposure to stresses above the Recommended Operating Conditions may affect device reliability.



ON Semiconductor®

<http://onsemi.com>

$V_{(BR)DSS}$	$R_{DS(on)}$ Max	I_D Max
-20 V	220 m Ω	-1.3 A

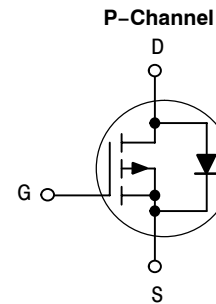

MARKING DIAGRAM & PIN ASSIGNMENT

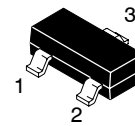

**SOT-23
CASE 318
STYLE 21**

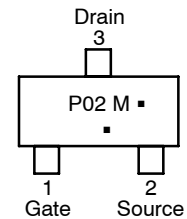

P02 = Specific Device Code
M = Date Code*
▪ = Pb-Free Package

(Note: Microdot may be in either location)
*Date Code orientation may vary depending upon manufacturing location.

ORDERING INFORMATION

Device	Package	Shipping†
NTR1P02LT1	SOT-23	3000 Tape & Reel
NTR1P02LT1G	SOT-23 (Pb-Free)	3000 Tape & Reel
NTR1P02LT3	SOT-23	10,000 Tape & Reel
NTR1P02LT3G	SOT-23 (Pb-Free)	10,000 Tape & Reel

†For information on tape and reel specifications, including part orientation and tape sizes, please refer to our Tape and Reel Packaging Specifications Brochure, BRD8011/D.

NTR1P02LT1

ELECTRICAL CHARACTERISTICS ($T_A = 25^\circ\text{C}$ unless otherwise noted)

Characteristic	Symbol	Min	Typ	Max	Unit
----------------	--------	-----	-----	-----	------

OFF CHARACTERISTICS

Drain-to-Source Breakdown Voltage ($V_{GS} = 0\text{ V}$, $I_D = -10\ \mu\text{A}$)	$V_{(BR)DSS}$	-20			V
Zero Gate Voltage Drain Current ($V_{DS} = -16\text{ V}$, $V_{GS} = 0\text{ V}$) ($V_{DS} = -16\text{ V}$, $V_{GS} = 0\text{ V}$, $T_J = 125^\circ\text{C}$)	I_{DSS}			-1.0 -10	μA
Gate-Body Leakage Current ($V_{GS} = \pm 12\text{ V}$, $V_{DS} = 0\text{ V}$)	I_{GSS}			± 100	nA

ON CHARACTERISTICS (Note 1)

Gate Threshold Voltage ($V_{DS} = V_{GS}$, $I_D = -250\ \mu\text{A}$)	$V_{GS(th)}$	-0.7	-1.0	-1.25	V
Static Drain-to-Source On-Resistance ($V_{GS} = -4.5\text{ V}$, $I_D = -0.75\text{ A}$) ($V_{GS} = -2.5\text{ V}$, $I_D = -0.5\text{ A}$)	$r_{DS(on)}$		0.135 0.190	0.22 0.35	Ω

DYNAMIC CHARACTERISTICS

Input Capacitance	($V_{DS} = -5.0\text{ V}$)	C_{iss}		225	pF
Output Capacitance	($V_{DS} = -5.0\text{ V}$)	C_{oss}		130	
Transfer Capacitance	($V_{DG} = -5.0\text{ V}$)	C_{rss}		55	

SWITCHING CHARACTERISTICS (Note 2)

Turn-On Delay Time	(V _{DD} = -5.0 V, I _D = -1.0 A, R _L = 5.0 Ω , R _G = 6.0 Ω)	$t_{d(on)}$		7.0	ns
Rise Time		t_r		15	
Turn-Off Delay Time		$t_{d(off)}$		18	
Fall Time		t_f		20	
Total Gate Charge	(V _{DS} = -16 V, I _D = -1.5 A, V _{GS} = -4.0 V)	Q_T		5500	pC

SOURCE-DRAIN DIODE CHARACTERISTICS

Continuous Current	I_S			-0.6	A
Pulsed Current	I_{SM}			-0.75	
Forward Voltage (Note 2) ($V_{GS} = 0\text{ V}$, $I_S = -0.6\text{ A}$)	V_{SD}			-1.0	V
Reverse Recovery Time	(I _S = -1.0 A, V _{GS} = 0 V, di/dt = 100 A/ μs)	t_{rr}		16	ns
		t_a		11	
		t_b		5.5	
Reverse Recovery Stored Charge	Q_{RR}			0.0085	μC

1. Pulse Test: Pulse Width $\leq 300\ \mu\text{s}$, Duty Cycle $\leq 2\%$.
2. Switching characteristics are independent of operating junction temperature.

NTR1P02LT1

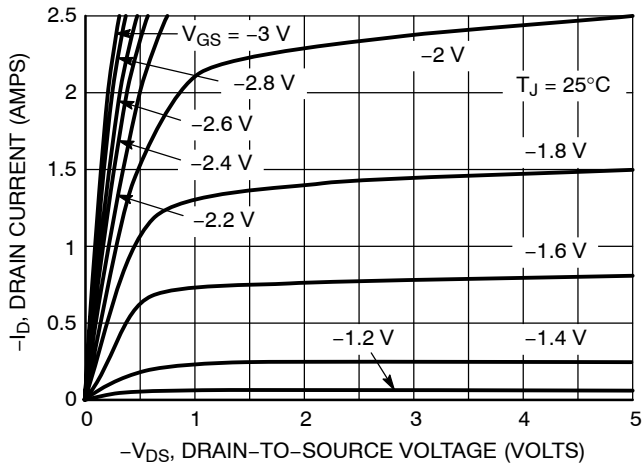

Figure 1. On-Region Characteristics

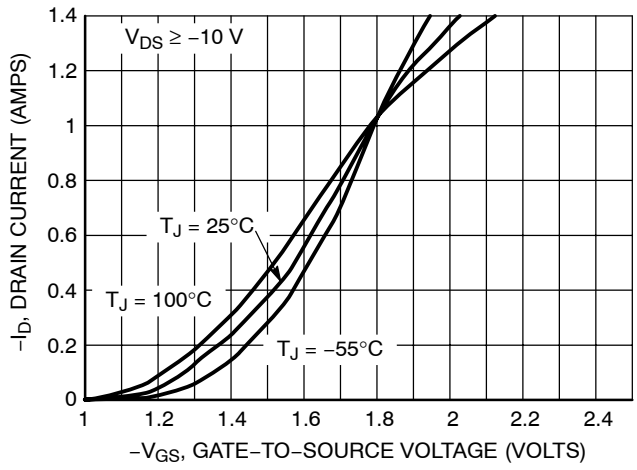

Figure 2. Transfer Characteristics

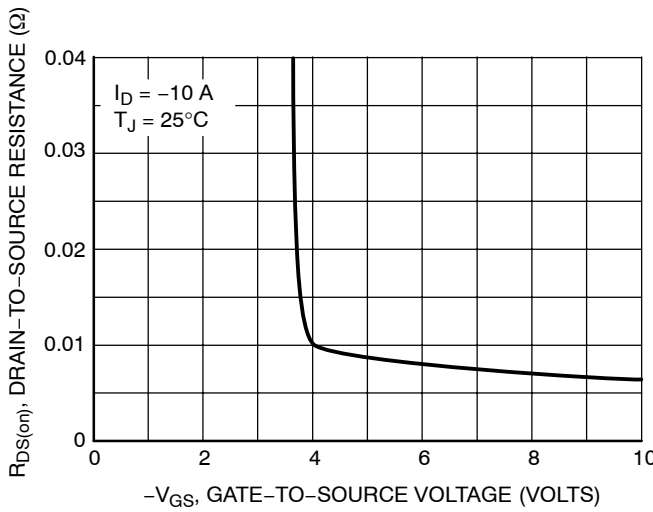

Figure 3. On-Resistance versus Gate-to-Source Voltage

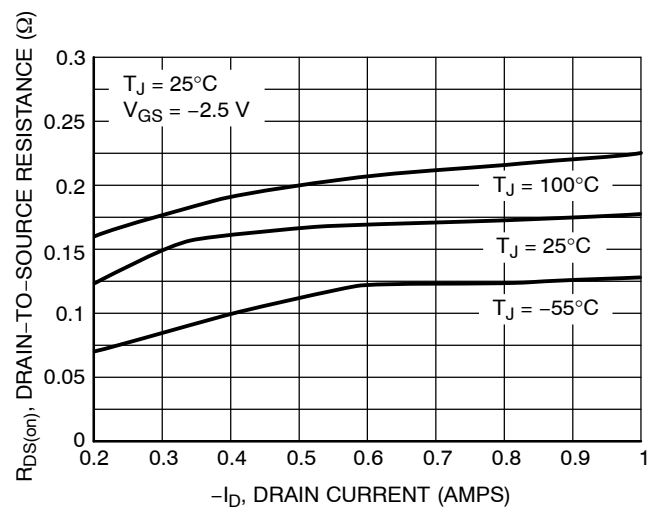

Figure 4. On-Resistance versus Drain Current and Gate Voltage

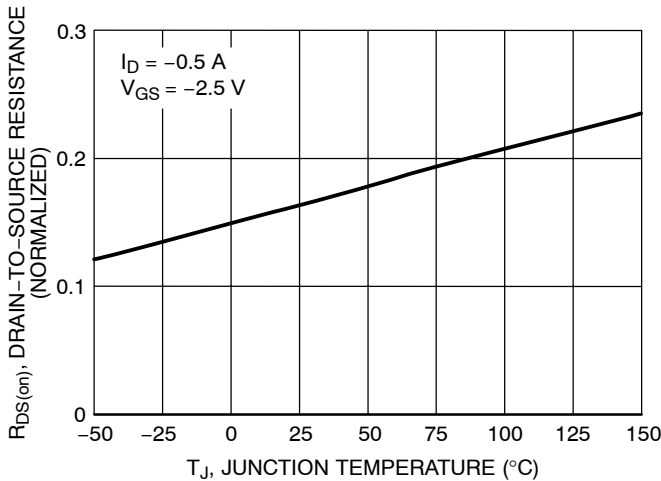

Figure 5. On-Resistance Variation with Temperature

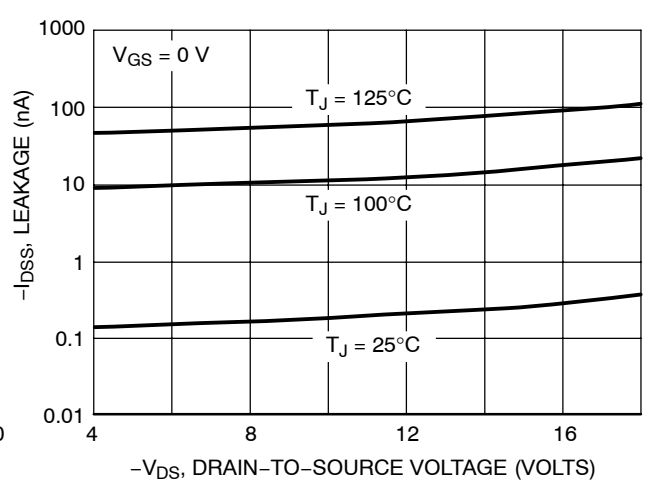

Figure 6. Drain-to-Source Leakage Current versus Voltage

NTR1P02LT1

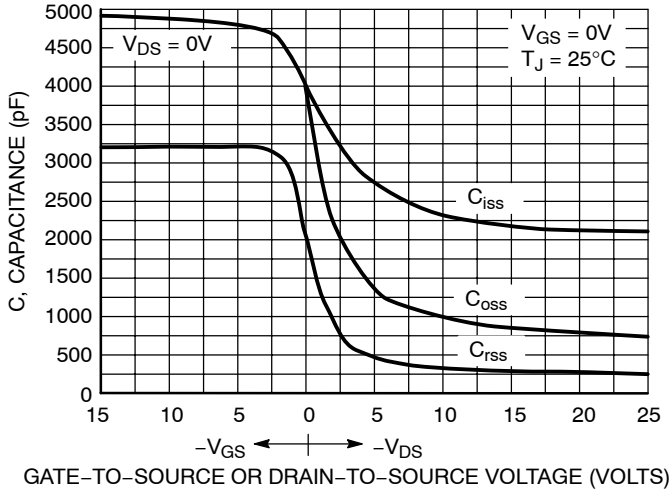

Figure 7. Capacitance Variation

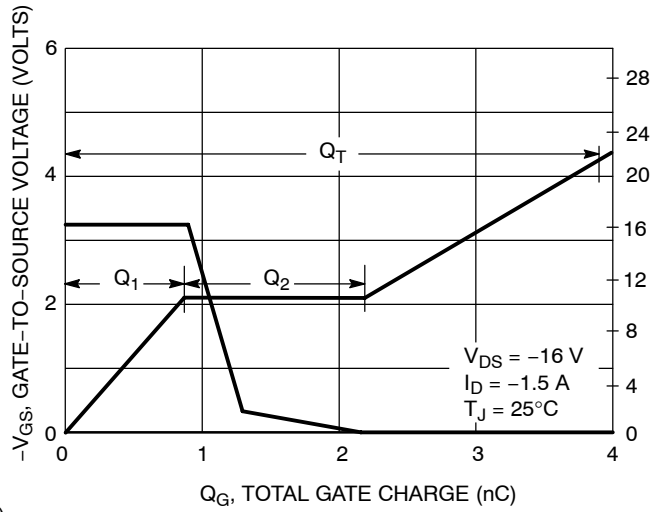

Figure 8. Gate-to-Source and Drain-to-Source Voltage versus Total Charge

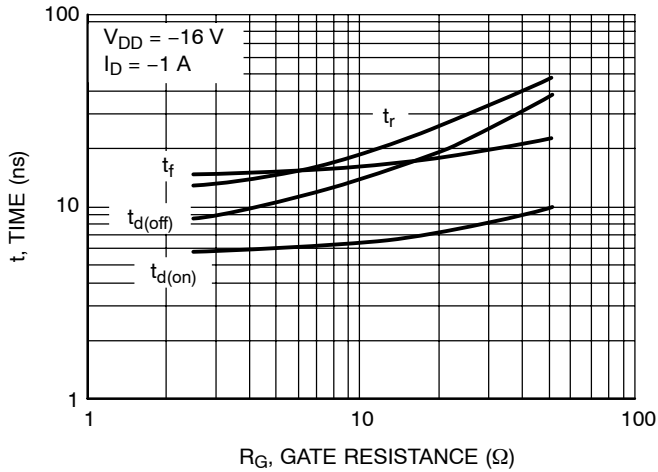

Figure 9. Resistive Switching Time Variation versus Gate Resistance

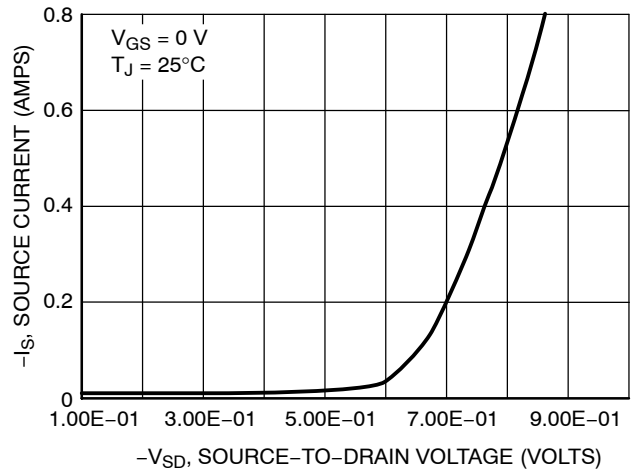
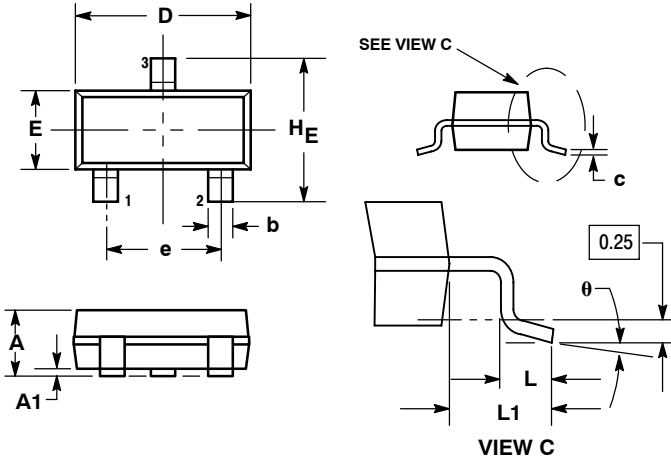

Figure 10. Diode Forward Voltage versus Current

NTR1P02LT1

PACKAGE DIMENSIONS

SOT-23 (TO-236)
CASE 318-08
ISSUE AN



NOTES:

1. DIMENSIONING AND TOLERANCING PER ANSI Y14.5M, 1982.
2. CONTROLLING DIMENSION: INCH.
3. MAXIMUM LEAD THICKNESS INCLUDES LEAD FINISH THICKNESS. MINIMUM LEAD THICKNESS IS THE MINIMUM THICKNESS OF BASE MATERIAL.
4. 318-01 THRU -07 AND -09 OBSOLETE, NEW STANDARD 318-08.

DIM	MILLIMETERS			INCHES		
	MIN	NOM	MAX	MIN	NOM	MAX
A	0.89	1.00	1.11	0.035	0.040	0.044
A1	0.01	0.06	0.10	0.001	0.002	0.004
b	0.37	0.44	0.50	0.015	0.018	0.020
c	0.09	0.13	0.18	0.003	0.005	0.007
D	2.80	2.90	3.04	0.110	0.114	0.120
E	1.20	1.30	1.40	0.047	0.051	0.055
e	1.78	1.90	2.04	0.070	0.075	0.081
L	0.10	0.20	0.30	0.004	0.008	0.012
L1	0.35	0.54	0.69	0.014	0.021	0.029
HE	2.10	2.40	2.64	0.083	0.094	0.104

STYLE 21:

1. GATE
2. SOURCE
3. DRAIN

SOLDERING FOOTPRINT*

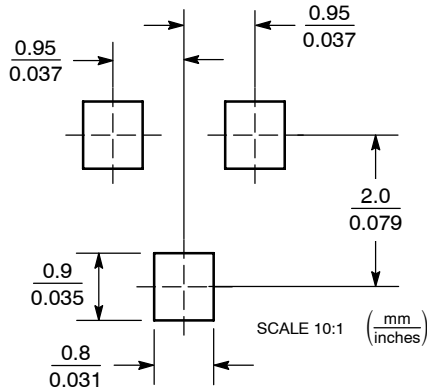

*For additional information on our Pb-Free strategy and soldering details, please download the ON Semiconductor Soldering and Mounting Techniques Reference Manual, SOLDERRM/D.

ON Semiconductor and are registered trademarks of Semiconductor Components Industries, LLC (SCILLC). SCILLC reserves the right to make changes without further notice to any products herein. SCILLC makes no warranty, representation or guarantee regarding the suitability of its products for any particular purpose, nor does SCILLC assume any liability arising out of the application or use of any product or circuit, and specifically disclaims any and all liability, including without limitation special, consequential or incidental damages. "Typical" parameters which may be provided in SCILLC data sheets and/or specifications can and do vary in different applications and actual performance may vary over time. All operating parameters, including "Typicals" must be validated for each customer application by customer's technical experts. SCILLC does not convey any license under its patent rights nor the rights of others. SCILLC products are not designed, intended, or authorized for use as components in systems intended for surgical implant into the body, or other applications intended to support or sustain life, or for any other application in which the failure of the SCILLC product could create a situation where personal injury or death may occur. Should Buyer purchase or use SCILLC products for any such unintended or unauthorized application, Buyer shall indemnify and hold SCILLC and its officers, employees, subsidiaries, affiliates, and distributors harmless against all claims, costs, damages, and expenses, and reasonable attorney fees arising out of, directly or indirectly, any claim of personal injury or death associated with such unintended or unauthorized use, even if such claim alleges that SCILLC was negligent regarding the design or manufacture of the part. SCILLC is an Equal Opportunity/Affirmative Action Employer. This literature is subject to all applicable copyright laws and is not for resale in any manner.

PUBLICATION ORDERING INFORMATION

LITERATURE FULFILLMENT:
Literature Distribution Center for ON Semiconductor
P.O. Box 5163, Denver, Colorado 80217 USA
Phone: 303-675-2175 or 800-344-3860 Toll Free USA/Canada
Fax: 303-675-2176 or 800-344-3867 Toll Free USA/Canada
Email: orderlit@onsemi.com

N. American Technical Support: 800-282-9855 Toll Free
USA/Canada
Europe, Middle East and Africa Technical Support:
Phone: 421 33 790 2910
Japan Customer Focus Center
Phone: 81-3-5773-3850

ON Semiconductor Website: www.onsemi.com
Order Literature: <http://www.onsemi.com/orderlit>

For additional information, please contact your local Sales Representative