

MSAU100 Series

1W, Miniature SMD, Single Output DC/DC Converters

Key Features

- Efficiency up to 82%
- 1000VDC Isolation
- MTBF > 2,000,000 Hours
- Low Cost
- Input 5 and 12VDC
- Output 3.3, 5, 9, 12 and 15VDC
- Temperature Performance -40°C to $+85^{\circ}\text{C}$
- Lead Frame Technology
- UL 94V-0 Package Material
- Interanl SMD Construction

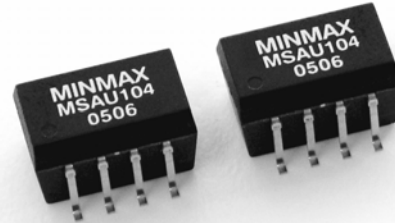

Minmax's MSAU100 1W DC/DC's are in "gull-wing" SMT package, weigh a mere 1.5 grams and meet $245^{\circ}\text{C}/10\text{sec}$ in solder-reflow for lead free process.

The series consists of 9 models with input voltages of 5V and 12VDC which offers standard single output voltages of 3.3V, 5V, 9V, 12V and 15VDC for the choice.

Their impressive guaranteed efficiencies enable all models to deliver their fully rated output power from -40°C to $+85^{\circ}\text{C}$ without heat sinking or forced-air cooling.

The MSAU100 series is an excellent selection for a variety of applications including data communication equipments, distributed power systems, telecommunication equipments and industrial robot systems.

The MSAU100 units are available in tape and reel package.

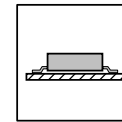

SMD

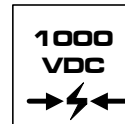

I/O Isolation

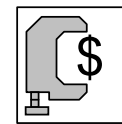

Low Cost

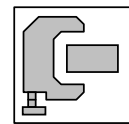

Low Profile

Block Diagram

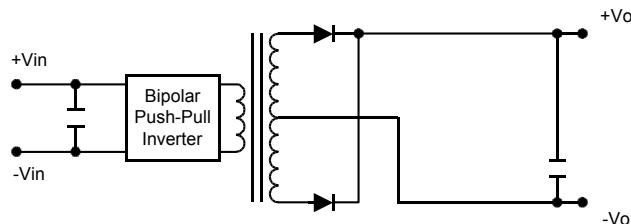

Model Selection Guide

Model Number	Input Voltage	Output Voltage	Output Current		Input Current		Load Regulation	Efficiency
			Max.	Min.	@Max. Load	@No Load		
	VDC	VDC	mA	mA	mA (Typ.)	mA (Typ.)	% (Max.)	% (Typ.)
MSAU101	5 (4.5 ~ 5.5)	5	200	4	250	30	10	80
MSAU102		9	110	2	254		10	78
MSAU103		12	84	1.5	252		8	80
MSAU104		15	67	1	248		7	81
MSAU105		3.3	300	60	264		10	75
MSAU111	12 (10.8 ~ 13.2)	5	200	4	103	15	8	81
MSAU112		9	110	2	106		8	78
MSAU113		12	84	1.5	104		5	81
MSAU114		15	67	1	102		5	82

Absolute Maximum Ratings

Parameter		Min.	Max.	Unit
Input Surge Voltage (1000 mS)	5VDC Input Models	-0.7	9	VDC
	12VDC Input Models	-0.7	18	VDC
Lead Temperature (1.5mm from case for 10 Sec.)		---	260	°C
Internal Power Dissipation		---	450	mW

Exceeding the absolute maximum ratings of the unit could cause damage. These are not continuous operating ratings.

Notes :

- Specifications typical at $T_a = +25^\circ\text{C}$, resistive load, nominal input voltage, rated output current unless otherwise noted.
- Ripple & Noise measurement bandwidth is 0-20 MHz.
- These power converters require a minimum output loading to maintain specified regulation.
- Operation under no-load conditions will not damage these modules; however, they may not meet all specifications listed.
- All DC/DC converters should be externally fused at the front end for protection.
- Other input and output voltage may be available, please contact factory.
- Specifications subject to change without notice.

Environmental Specifications

Parameter	Conditions	Min.	Max.	Unit
Operating Temperature	Ambient	-40	+85	°C
Operating Temperature	Case	-40	+90	°C
Storage Temperature		-40	+125	°C
Humidity		---	95	%
Cooling	Free-Air Convection			

Input Specifications

Parameter	Model	Min.	Typ.	Max.	Unit
Input Voltage Range	5V Input Models	4.5	5	5.5	VDC
	12V Input Models	10.8	12	13.2	
Reverse Polarity Input Current	All Models	---	---	0.3	A
Input Filter		Internal Capacitor			

MSAU100 Series

Output Specifications

Parameter	Conditions	Min.	Typ.	Max.	Unit
Output Voltage Accuracy		---	± 1.0	± 3.0	%
Line Regulation	For V_{in} Change of 1%	---	± 1.2	± 1.5	%
Load Regulation	$I_o=20\%$ to 100%	See Model Selection Guide			%
Ripple & Noise (20MHz)		---	60	120	mV P-P
Ripple & Noise (20MHz)	Over Line, Load & Temp.	---	---	150	mV P-P
Ripple & Noise (20MHz)		---	---	5	mV rms
Over Load		120	---	---	%
Temperature Coefficient		---	± 0.01	± 0.02	%/°C
Output Short Circuit	0.5 Second Max.				

General Specifications

Parameter	Conditions	Min.	Typ.	Max.	Unit
Isolation Voltage Rated	60 Seconds	1000	---	---	VDC
Isolation Voltage Test	Flash Tested for 1 Second	1100	---	---	VDC
Isolation Resistance	500VDC	1000	---	---	M Ω
Isolation Capacitance	100KHz, 1V	---	40	100	pF
Switching Frequency		50	100	140	KHz
MTBF	MIL-HDBK-217F @ 25°C, Ground Benign	2000	---	---	K Hours

Capacitive Load

Models by Vout	3.3V	5V	9V	12V	15V	Unit
Maximum Capacitive Load	33	33	33	33	33	μ F

Input Fuse Selection Guide

5V Input Models	12V Input Models
500mA Slow – Blow Type	200mA Slow – Blow Type

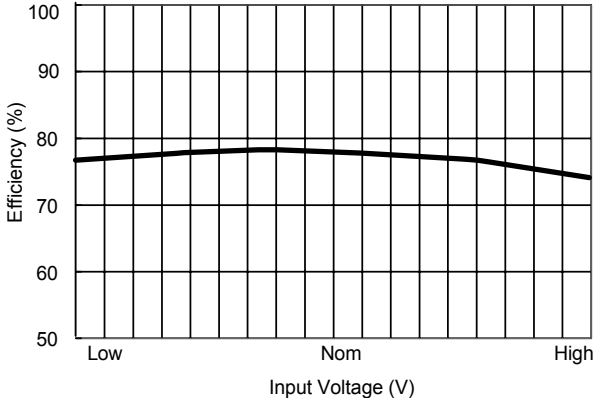

Efficiency vs Input Voltage

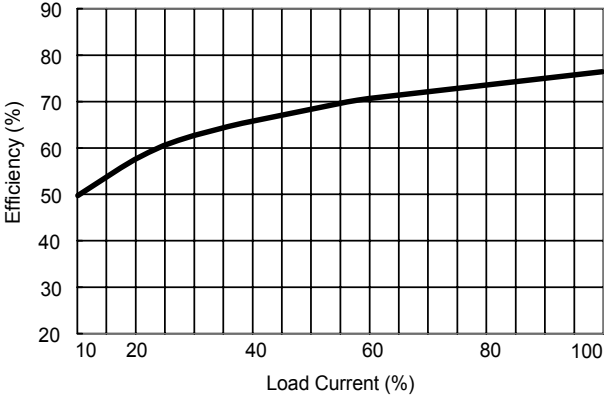

Efficiency vs Output Load

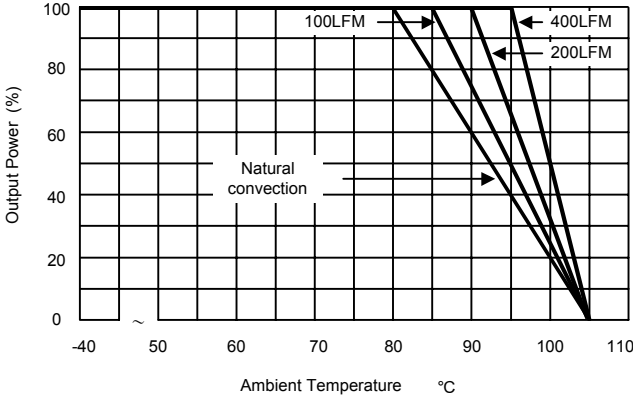

Derating Curve

Test Configurations

Input Reflected-Ripple Current Test Setup

Input reflected-ripple current is measured with an inductor L_{in} (4.7uH) and C_{in} (220uF, ESR < 1.0Ω at 100 KHz) to simulate source impedance.

Capacitor C_{in} , offsets possible battery impedance.

Current ripple is measured at the input terminals of the module, measurement bandwidth is 0–500 KHz.

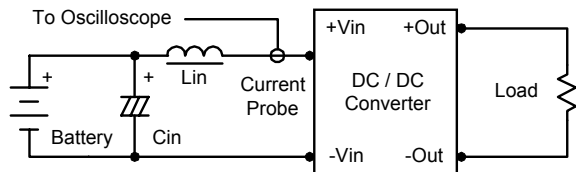

Peak-to-Peak Output Noise Measurement Test

Use a C_{out} 0.33uF ceramic capacitor.

Scope measurement should be made by using a BNC socket, measurement bandwidth is 0–20 MHz. Position the load between 50 mm and 75 mm from the DC/DC Converter.

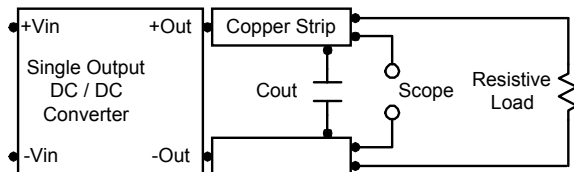

Design & Feature Considerations

Maximum Capacitive Load

The MSAU100 series has limitation of maximum connected capacitance at the output.

The power module may be operated in current limiting mode during start-up, affecting the ramp-up and the startup time.

For optimum performance we recommend 33uF maximum capacitive load.

The maximum capacitance can be found in the data sheet.

Input Source Impedance

The power module should be connected to a low ac-impedance input source. Highly inductive source impedances can affect the stability of the power module.

In applications where power is supplied over long lines and output loading is high, it may be necessary to use a capacitor at the input to ensure startup.

Capacitor mounted close to the power module helps ensure stability of the unit, it is recommended to use a good quality low Equivalent Series Resistance (ESR < 1.0Ω at 100

KHz) capacitor of 2.2uF for the 5V input devices, and a 1.0uF for the 12V devices.

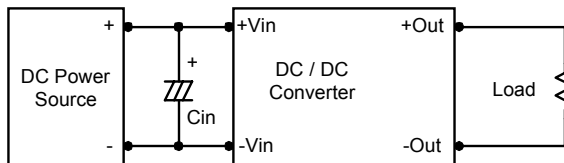

Output Ripple Reduction

A good quality low ESR capacitor placed as close as practicable across the load will give the best ripple and noise performance.

To reduce output ripple, it is recommended to use 0.47uF capacitors at the output.

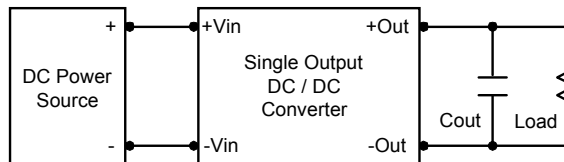

Thermal Considerations

Many conditions affect the thermal performance of the power module, such as orientation, airflow over the module and board spacing. To avoid exceeding the maximum temperature rating of the components inside the power module, the case temperature must be kept below 90°C.

The derating curves are determined from measurements obtained in an experimental apparatus.

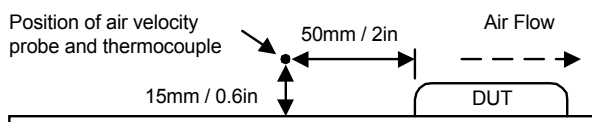

Mechanical Dimensions

Connecting Pin Patterns Top View (2.54 mm / 0.1 inch grids)

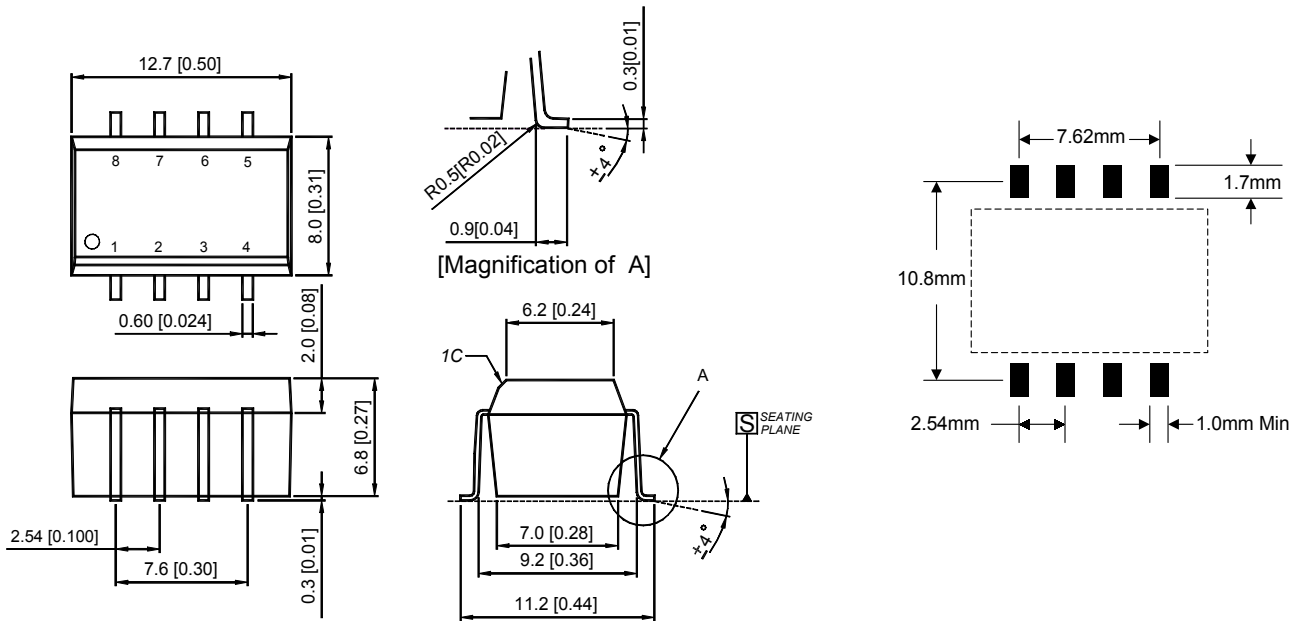

Tolerance	Millimeters	Inches
	$X.X \pm 0.25$	$X.XX \pm 0.01$
	$X.XX \pm 0.13$	$X.XXX \pm 0.005$
Pin	± 0.05	± 0.002

Pin Connections

Pin	Function
1	-Vin
2	+Vin
3	NA
4	-Vout
5	+Vout
6	NA
7	NA
8	NA

NA : Not Available for Electrical Connection

Physical Characteristics

Case Size	: 12.7×8.0×6.8 mm 0.50×0.31×0.27 inches
Case Material	: Molding
Weight	: 1.5g
Flammability	: UL94V-0

The MSAU100 converter is encapsulated in a low thermal resistance molding compound that has excellent resistance/electrical characteristics over a wide temperature range or in high humidity environments.
The encapsulant and unit case are both rated to UL 94V-0 flammability specifications.
Leads are tin plated for improved solderability.

MSAU100 Series

Packaging Specifications

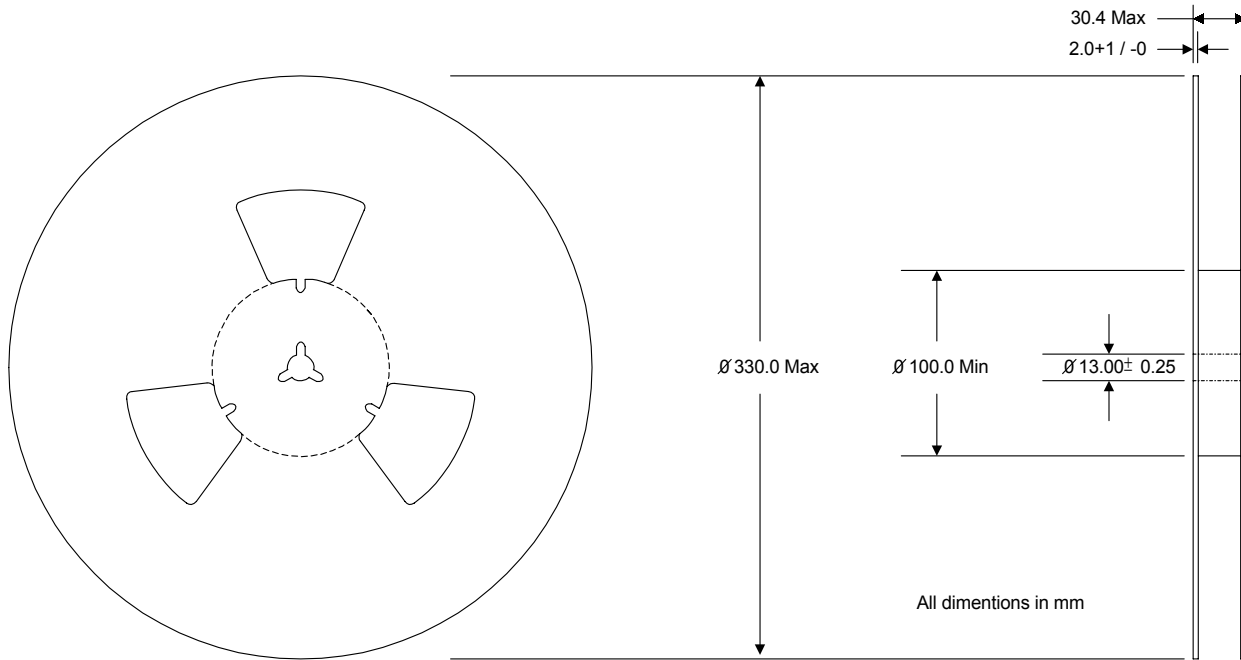

Tape

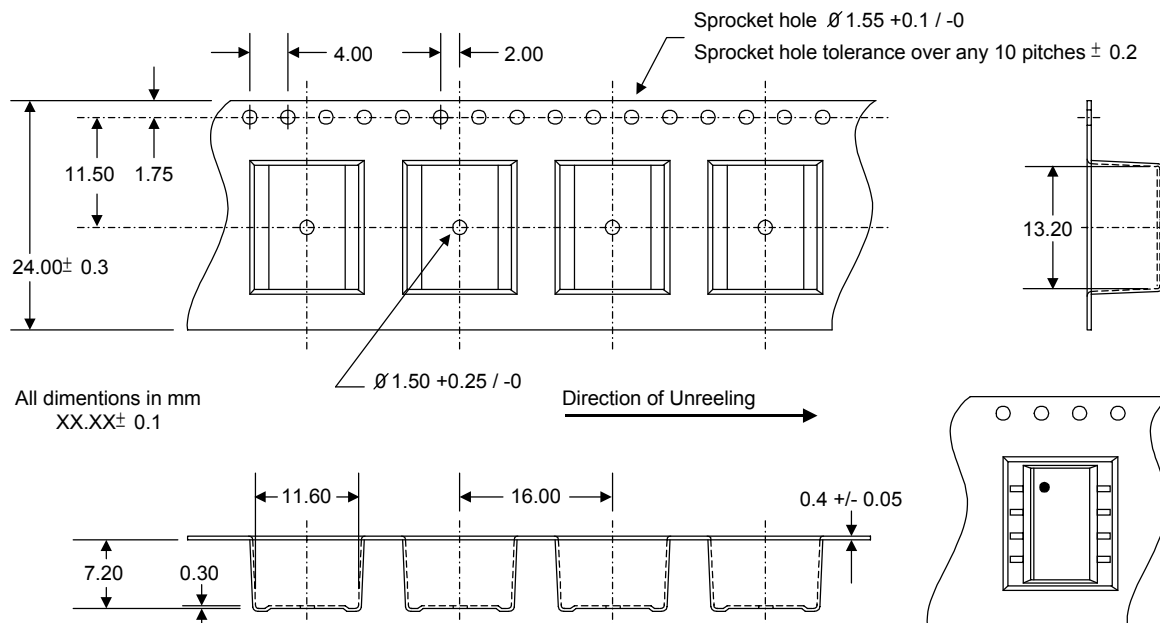

Tube

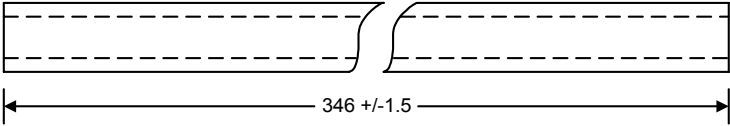
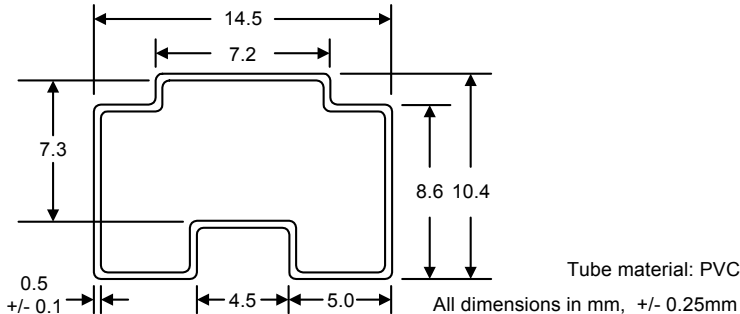

Packaging Details

Packaging Style	Quantity
Tube	25
Tape and Reel to IEC 286-3 Specifications	500