

SHARP

No.	LD - 15756B
DATE	Jun.03.2004

TECHNICAL LITERATURE
FOR
TFT - LCD module

T E N T A T I V E

MODEL No. **LQ170E1LG11**

The technical literature is subject to change without notice.
So, please contact Sharp or its representative before designing
your product based on this literature.

DEVELOPMENT ENGINEERING DEPARTMENT 2
TAKI DEVELOPMENT CENTER
AVC LIQUID CRYSTAL DISPLAY GROUP
SHARP CORPORATION

RECORDS OF REVISION

LQ170E1LG11

SPEC No.	DATE	REVISED No.	PAGE	SUMMARY	NOTE
LD-15756	July. 30. 2003				1st Issue
LD-15756A	Apr. 21. 2004	1	7	Added Lamp kick-off voltage (MAX.2150Vrms)	
			9	Changed Lamp current range Typ.(6.0mArms) (6.5mArms) Changed Lamp voltage Typ.(685Vrms) (650 Vrms) Max. (755Vrms) (720 Vrms) Changed Lamp power consumption Typ.(4.11W) (4.23 W) Max. (4.53W) (4.68 W) Added Note5 condition Above value is applicable when the long side of LCD module is placed horizontally.(Landscape position) (Lamp lifetime may vary if LCD module is in portrait position due to the change of mercury density inside the lamp.) Changed IL=(6.0)mArms IL=(6.5)mArms	
			10	Changed Clock Frequency Max.(57MHz) (67.5MHz) Changed Horizontal period Min.(705clock) (676clock) Max. (928clock) (1010clock) Changed Vertical period Min.(1026line) (1031line) Changed 【Note2】 Abbreviation ENAB1 DEA,DEB A side DA B side DB	
			11	Changed Display position of input data (H,V) (1,1) (1,2) (1,1) (2,1)	

1. Application

This technical literature applies to the color 17.0 SXGA TFT-LCD module LQ170E1LG11.

This technical literature are the proprietary product of SHARP CORPORATION("SHARP) and include materials protected under copyright of SHARP. Do not reproduce or cause any third party to reproduce them in any form or by any means, electronic or mechanical, for any purpose, in whole or in part, without the express written permission of SHARP.

The device listed in this technical literature was designed and manufactured for use in OA equipment.

In case of using the device for applications such as control and safety equipment for transportation(aircraft, trains, automobiles, etc.), rescue and security equipment and various safety related equipment which require higher reliability and safety, take into consideration that appropriate measures such as fail-safe functions and redundant system design should be taken.

Do not use the device for equipment that requires an extreme level of reliability, such as aerospace applications, telecommunication equipment(trunk lines), nuclear power control equipment and medical or other equipment for life support.

SHARP assumes no responsibility for any damage resulting from the use of the device which does not comply with the instructions and the precautions specified in these This technical literature sheets.

Contact and consult with a SHARP sales representative for any questions about this device.

2. Overview

This module is a color active matrix LCD module incorporating amorphous silicon TFT (Thin Film Transistor). It is composed of a color TFT-LCD panel, driver ICs, control circuit, power supply circuit and a back light unit. Graphics and texts can be displayed on a 1280 × RGB × 1024 dots panel with about 16 million colors (6bit + 2bitFRC) by using LVDS (Low Voltage Differential Signaling) and supplying +5.0V DC supply voltages for TFT-LCD panel driving and supply voltage for backlight.

3. Mechanical Specifications

Parameter	Specifications	Unit
Display size	43 (Diagonal)	cm
	17.0 (Diagonal)	Inch
Active area	337.9 (H) × 270.3 (V)	mm
Pixel format	1280 (H) × 1024 (V)	Pixel
	(1 pixel = R+G+B dots)	
Pixel pitch	0.264 (H) × 0.264 (V)	mm
Pixel configuration	R, G, B vertical stripe	
Display mode	Normally white	
Unit outline dimensions *1	358.5(W) × 296.5(H) × 17.0(D) typ.	mm
Mass	(1900) MAX .	g
Surface treatment	Anti-glare and hard-coating 3H (Haze value = 25)	

*1.Note: excluding back light cables.

The thickness of module (D) doesn't contain the projection.

Outline dimensions are shown in Fig.1.

4. Input Terminals

4-1. TFT-LCD panel driving

CN1 (Interface signals and +5.0V DC power supply)

Using connectors : FI-XB30SL-HF10 (Japan Aviation Electronics Ind, Ltd) or
MDF76KAW-30S-1H (Hirose Electric Co., Ltd.) or
equivalent

Corresponding connectors : FI-X30C *, FI-X30H *, FI-X30M * (Japan Aviation Electronics Ind, Ltd)
or

MDF76G-30P-1SD (Hirose Electric Co., Ltd.) or equivalent

Corresponding LVDS Transmitter : THC63LVDM83R(Thine) or compatible

Pin No.	Symbol	Function	Remark
1	RAin0-	Negative (-) LVDS CH0 differential data input (A port)	LVDS
2	RAin0+	Positive (+) LVDS CH0 differential data input (A port)	LVDS
3	RAin1-	Negative (-) LVDS CH1 differential data input (A port)	LVDS
4	RAin1+	Positive (+) LVDS CH1 differential data input (A port)	LVDS
5	RAin2-	Negative (-) LVDS CH2 differential data input (A port)	LVDS
6	RAin2+	Positive (+) LVDS CH2 differential data input (A port)	LVDS
7	GND	GND	
8	CKAin-	Negative (-) LVDS differential clock input (A port)	LVDS
9	CKAin+	Positive (+) LVDS differential clock input (A port)	LVDS
10	RAin3-	Negative (-) LVDS CH3 differential data input (A port)	LVDS
11	RAin3+	Positive (+) LVDS CH3 differential data input (A port)	LVDS
12	RBIn0-	Negative (-) LVDS CH0 differential data input (B port)	LVDS
13	RBIn0+	Positive (+) LVDS CH0 differential data input (B port)	LVDS
14	GND	GND	
15	RBIn1-	Negative (-) LVDS CH1 differential data input (B port)	LVDS
16	RBIn1+	Positive (+) LVDS CH1 differential data input (B port)	LVDS
17	GND	GND	
18	RBIn2-	Negative (-) LVDS CH2 differential data input (B port)	LVDS
19	RBIn2+	Positive (+) LVDS CH2 differential data input (B port)	LVDS
20	CKBin-	Negative (-) LVDS differential clock input (B port)	LVDS
21	CKBin+	Positive (+) LVDS differential clock input (B port)	LVDS
22	RBIn3-	Negative (-) LVDS CH3 differential data input (B port)	LVDS
23	RBIn3+	Positive (+) LVDS CH3 differential data input (B port)	LVDS
24	GND	GND	
25	NC	No Connection	
26	NC	No Connection	
27	NC	No Connection	
28	VCC	+5V power supply	
29	VCC	+5V power supply	
30	VCC	+5V power supply	

【Note1】 This module has dual pixel port to receive dual pixel data at the same time . A port receives first pixel data and B port receives second pixel data in dual pixel data.

4-2 Data Mapping

【note1】 pin assignment with LVDS_SET pin (Thine:THC63LVDM83R)

Transmitter		Data arrangement
Pin No	Data	
51	TA0	R0(LSB)
52	TA1	R1
54	TA2	R2
55	TA3	R3
56	TA4	R4
3	TA5	R5
4	TA6	G0(LSB)
6	TB0	G1
7	TB1	G2
11	TB2	G3
12	TB3	G4
14	TB4	G5
15	TB5	B0(LSB)
19	TB6	B1
20	TC0	B2
22	TC1	B3
23	TC2	B4
24	TC3	B5
27	TC4	(NA)
28	TC5	(NA)
30	TC6	DE
50	TD0	R6
2	TD1	R7(MSB)
8	TD2	G6
10	TD3	G7(MSB)
16	TD4	B6
18	TD5	B7(MSB)
25	TD6	(NA)

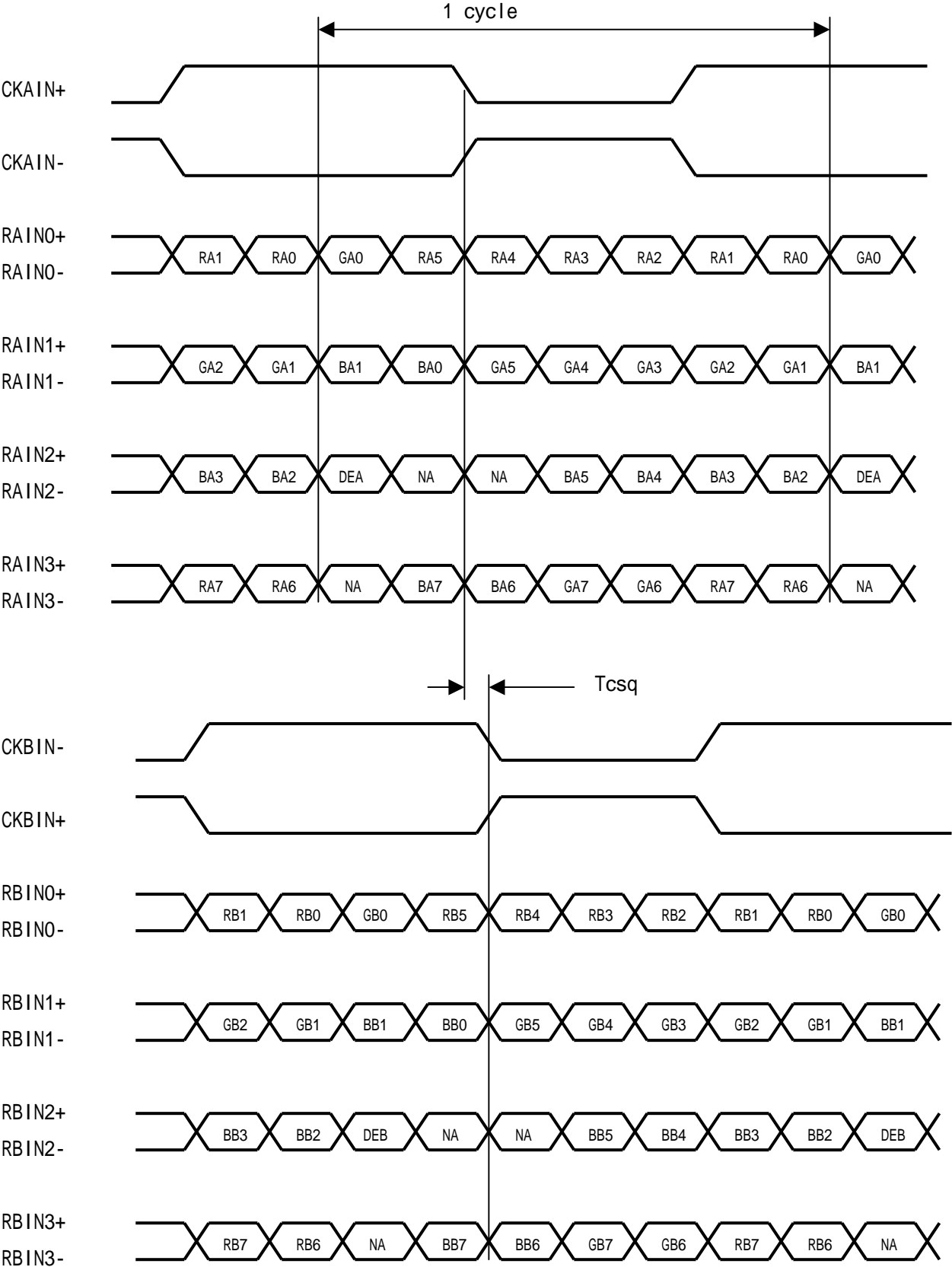

DE: Display Enable

NA: Not Available

Interface block diagram

Using receiver: LVDS6CP_BU72**(ROHM)/THC63LVD824(Thine) built-in control IC, Corresponding Transmitter:THC63LVDM83R(THine electronics) or compatible

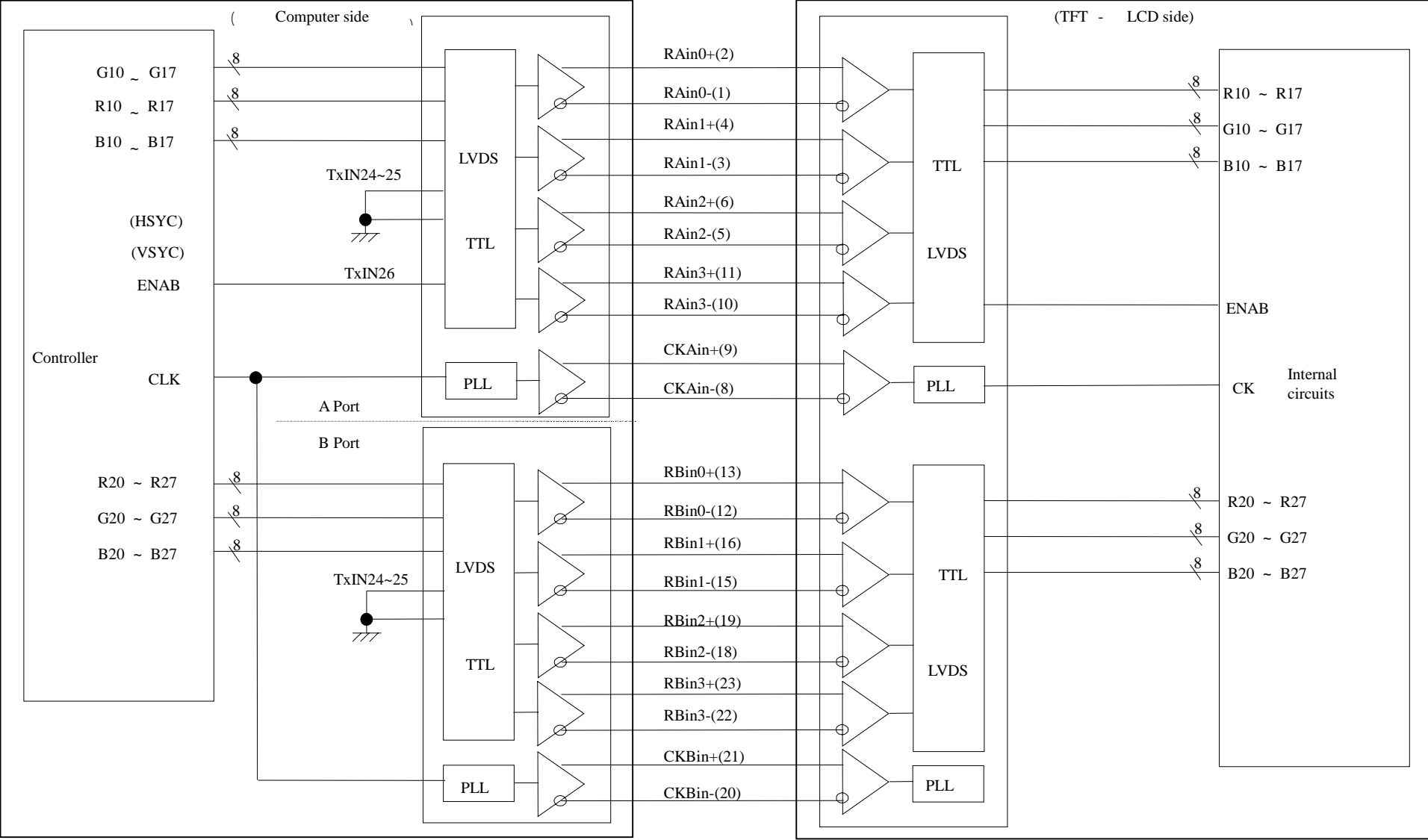

4-4 Backlight

CN 2, 3, 4, 5

The module-side connector : BHSR-02VS-1 (JST)

The user-side connector : SM02B-BHSS-1-TB (JST)

Pin no.	symbol	I/O	Function
1	V _{HIGH}	I	Power supply for lamp (High voltage side)
2	V _{LOW}	I	Power supply for lamp (Low voltage side)

5. Absolute Maximum Ratings

Parameter	Symbol	Condition	Ratings	Unit	Remark
Supply voltage	V _{CC}	T _a =25	0 ~ +6.0	V	
Lamp kick-off voltage	V _S	-	(MAX.2150)	V _{rms}	
Storage temperature	T _{STG}	-	- 25 ~ + 60		【Note1】
Operating temperature (Ambient)	T _{OPA}	-	0 ~ + 50		

1

【Note1】 Humidity : 95%RH Max. (T_a 40)Maximum wet-bulb temperature at 39 or less. (T_a>40)

No condensation.

6. Electrical Characteristics

6-1. TFT-LCD panel driving

Ta = 25

Parameter		Symbol	Min.	Typ.	Max.	Unit	Remark
Vcc	Supply voltage	Vcc	+4.5	+5.0	+5.5	V	【Note2】
	Current dissipation	Icc	-	T.B.D	T.B.D	mA	【Note3】
Permissible input ripple voltage		V _{RF}	-	-	100	mVp-p	V _{CM} =+3.3V
Differential input threshold voltage	High	V _{TH}	-	-	+100	mV	V _{CM} =+1.2V 【Note1】
	Low	V _{TL}	-100	-	-	mV	
Terminal resistor		R _T	-	100	-		Differential input

【Note1】 V_{CM} : Common mode voltage of LVDS driver.

【Note2】

1) On-off sequences of Vcc and data

- 0 < t1 10ms
- 0 < t2 10ms
- 0 < t3 1s
- 1s t4
- 200ms t5

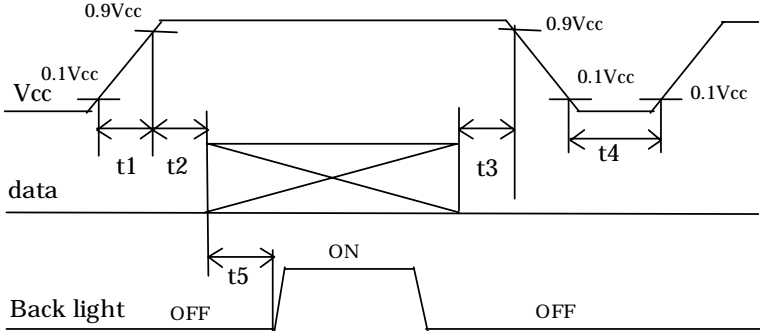

Power sequence for Backlight is not especially specified, however it is recommended to consider some timing difference between LVDS input and Backlight input as shown above.

If the Backlight lights on before LCD starting, or if the Backlight is kept on after LCD stopping, the screen may look white for a moment or abnormal image may be displayed.

This is caused by variation in output signal from timing generator at LVDS input on or off. It does not cause the damage to the LCD module.

2) Dip conditions for supply voltage

- 1) V2 Vcc < V1
td 10ms
- 2) Vcc < V2
Vcc-dip conditions should also follow the on-off conditions.

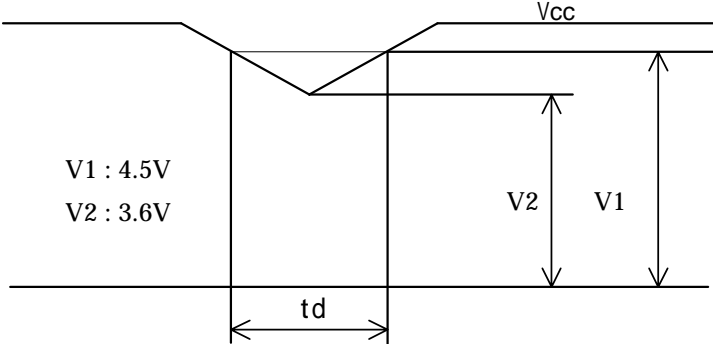

【Note3】 Typical current situation : 16-gray-bar pattern

Vcc=+5.0V, CK=54MHz
Horizontal period =15.7 us
Gray scale : GS(4n)
n=0 ~ 15

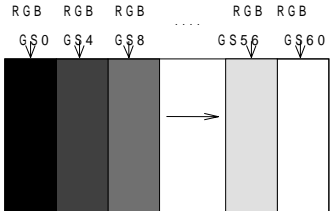

The explanation of each gray scale, GS(4n), is described below section 8-2.

6-2. Backlight

The back light system is an edge-lighting type with 4CCFTs (Cold Cathode Fluorescent Tube).

The characteristics of the lamp are shown in the following table.

The value mentioned below is at the case of one CCFT.

CCFT Model Name : TBD

Parameter	Symbol	Min.	Typ.	Max.	Unit	Remark
Lamp current range	I_L	(3.0)	(6.5)	(7.0)	mArms	【Note1】
Lamp voltage	V_L	-	(650)	(720)	Vrms	$I_L=(6.5)\text{mArms}$ $T_a=25$ (60)kHz
Lamp power consumption	P_L	-	(4.23)	(4.68)	W	【Note2】 $I_L=(6.5)\text{mArms}$ $T_a=25$ (60)kHz
Lamp frequency	F_L	(40)	(60)	(70)	kHz	【Note3】
Kick-off voltage	V_s	-	-	(1800)	Vrms	$T_a=0$ 【Note4】
Lamp life time	T_L	(50,000)	-	-	hour	【Note5】

1
1
1

【Note1】 A lamp can be light in the range of lamp current shown above.

Maximum rating for current is measured by high frequency current measurement equipment connected to V_{LOW} at circuit showed below.

(Note : To keep enough kick-off voltage and necessary steady voltage for CCFT.)

Lamp frequency : (40) ~ (70)kHz

Ambient temperature : 0 ~ 50

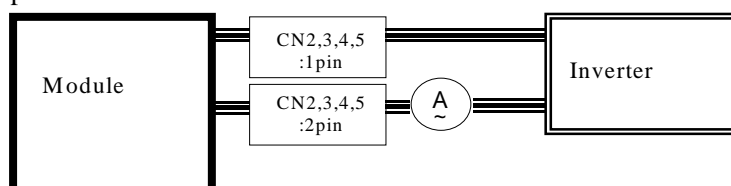

【Note2】 Referential data per one CCFT by calculation ($I_L \times V_L$).

The data don't include loss at inverter.

【Note3】 Lamp frequency of inverter may produce interference with horizontal synchronous frequency, and this may cause horizontal beat on the display. Therefore, adjust lamp frequency, and keep inverter as far as from module or use electronic shielding between inverter and module to avoid interference.

【Note4】 It is defined at 27pF for the ballast capacitor of a DC-AC inverter.

The kick-off voltage may rise up in the user set, please decide the open output voltage by checking not to occur lighting failure under operating state.

The open output voltage should be applied to the lamp for more than 1 second to startup.

Otherwise the lamp may not be turned on.

【Note5】 Above value is applicable when the long side of LCD module is placed horizontally.

(Landscape position)

(Lamp lifetime may vary if LCD module is in portrait position due to the change of mercury density inside the lamp.)

Lamp life time is defined as the time when either or occurs in the continuous operation under the condition of $T_a=25$ and $I_L=(6.5)$ mA rms.

Brightness becomes 50% of the original value under standard condition.

Kick-off voltage at $T_a=0$ exceeds (1800) V_{rms} value.

1
1
1

《Note》

The performance of the backlight, for example lifetime or brightness, is much influenced by the characteristics of the DC-AC inverter for the lamp. When you design or order the inverter, please make sure that a poor lighting caused by the mismatch of the backlight and the inverter (miss-lighting, flicker, etc.) never occurs. When you confirm it, the module should be operated in the same condition as it is installed in your instrument.

Use the lamp inverter power source incorporating such safeguard as overvoltage / overcurrent protective circuit or lamp voltage waveform detection circuit, which should have individual control of each lamp.

In case one circuit without such individual control is connected to more than two lamps, excessive current may flow into one lamp when the other one is not in operation.

7. Timing characteristics of input signals

7-1. Timing characteristics

Parameter		Symbol	Min.	Typ.	Max.	Unit	Remark
Clock	Frequency	1/Tc	40	54	(67.5)	MHz	
	Skew	Tcsq	-2	0	+2	ns	【Note1】
Data enable Signal	Horizontal period	TH	(676)	848	(1010)	clock	
			12.3	15.7	-	μs	
	Horizontal period (High)	THd	640	640	640	clock	
	Vertical period	TV	(1031)	1066	(2043)	line	【Note2】
			13.3	16.7	-	ms	
Vertical period (High)	TVd	1024	1024	1024	line		

【Note1】 Lvds (A Side data)– Lvds (B side data) phase difference

【Note2】 In case of using the long vertical period, the deterioration of display quality, flicker, etc., may occur.

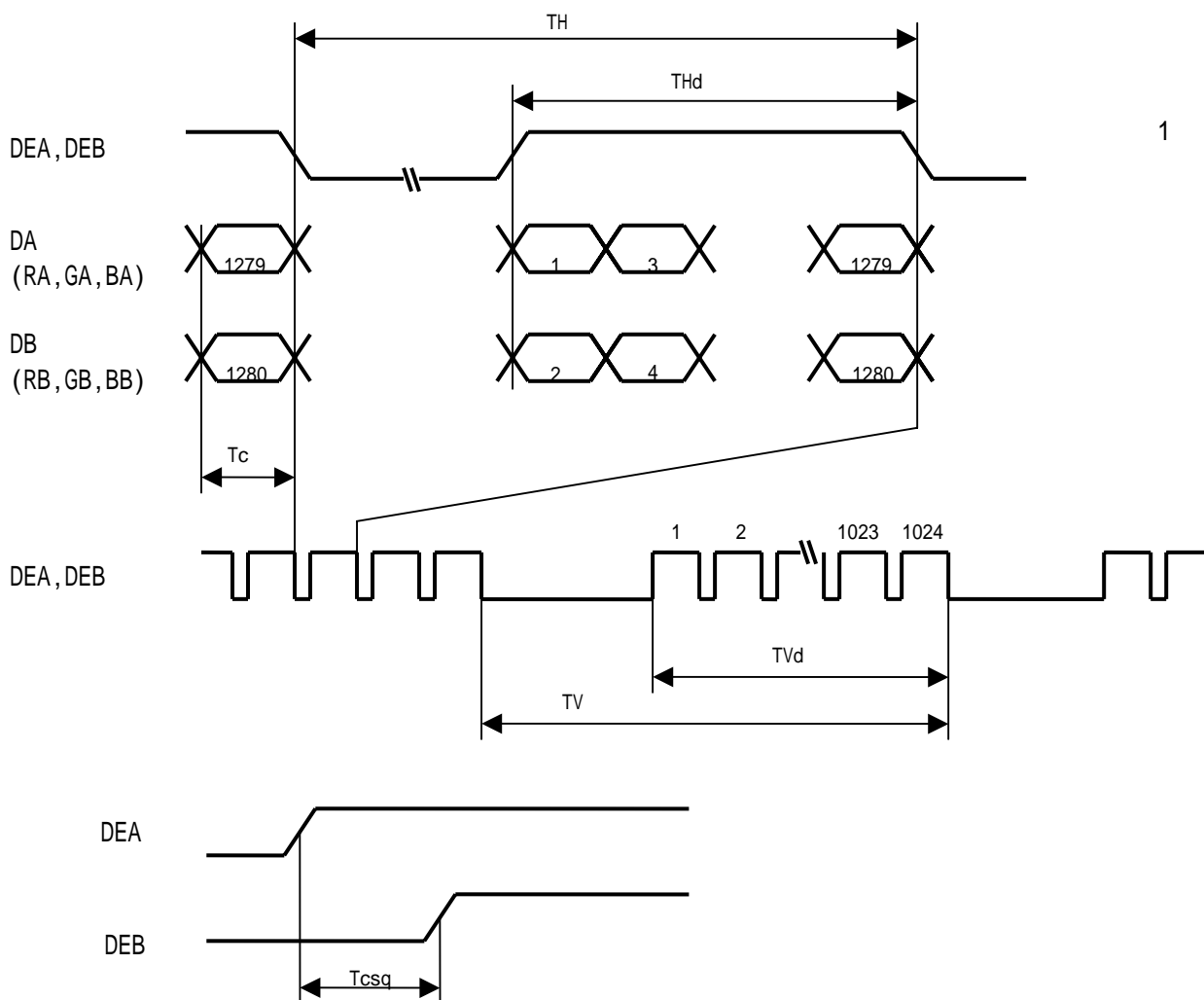

7-2. Input Data Signals and Display Position on the screen

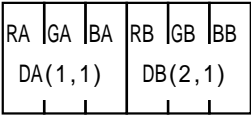

Two pixels-data are sampled at the same time.

* DA : RA0 ~ RA7, GA0 ~ GA7, BA0 ~ BA7

* DB : RB0 ~ RB7, GB0 ~ GB7, BB0 ~ BB7

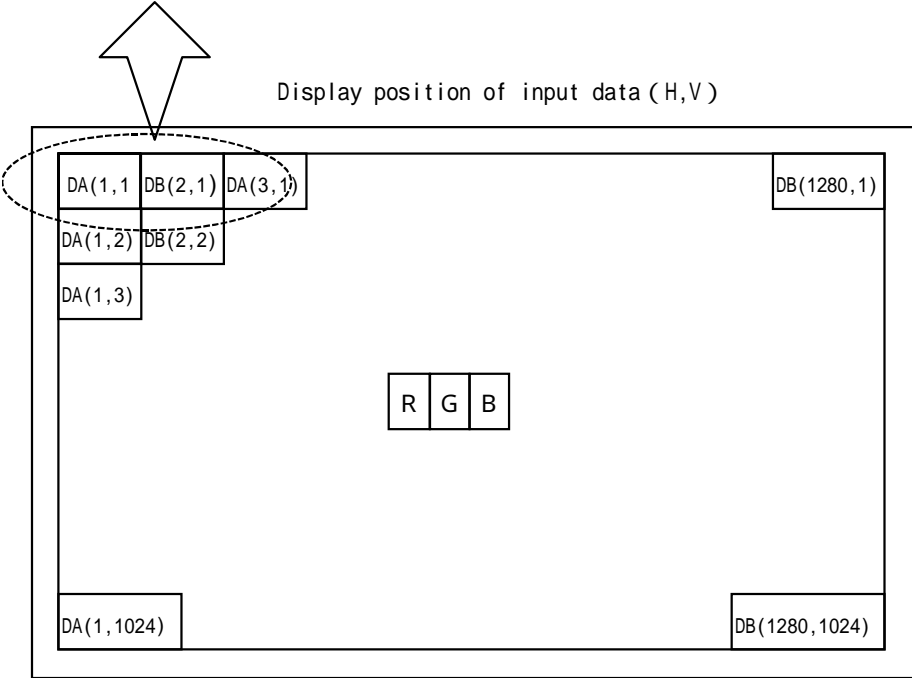

8. Input Signals, Basic Display Colors and Gray Scale of Each Color

	Colors & Gray scale	Data signal																								
		Gray Scale	R0	R1	R2	R3	R4	R5	R6	R7	G0	G1	G2	G3	G4	G5	G6	G7	B0	B1	B2	B3	B4	B5	B6	B7
Basic Color	Black	-	0	0	0	0	0	0	0	0	0	0	0	0	0	0	0	0	0	0	0	0	0	0	0	0
	Blue	-	0	0	0	0	0	0	0	0	0	0	0	0	0	0	0	0	X	X	1	1	1	1	1	1
	Green	-	0	0	0	0	0	0	0	0	X	X	1	1	1	1	1	1	0	0	0	0	0	0	0	0
	Cyan	-	0	0	0	0	0	0	0	0	X	X	1	1	1	1	1	1	X	X	1	1	1	1	1	1
	Red	-	X	X	1	1	1	1	1	1	0	0	0	0	0	0	0	0	0	0	0	0	0	0	0	0
	Magenta	-	X	X	1	1	1	1	1	1	0	0	0	0	0	0	0	0	X	X	1	1	1	1	1	1
	Yellow	-	X	X	1	1	1	1	1	1	X	X	1	1	1	1	1	1	0	0	0	0	0	0	0	0
	White	-	X	X	1	1	1	1	1	1	X	X	1	1	1	1	1	1	X	X	1	1	1	1	1	1
Gray Scale of Red	Black	GS0	0	0	0	0	0	0	0	0	0	0	0	0	0	0	0	0	0	0	0	0	0	0	0	0
	↑	GS1	1	0	0	0	0	0	0	0	0	0	0	0	0	0	0	0	0	0	0	0	0	0	0	0
	Darker	GS2	0	1	0	0	0	0	0	0	0	0	0	0	0	0	0	0	0	0	0	0	0	0	0	0
	↑	↓					↓								↓									↓		
	↓	↓					↓								↓									↓		
	Brighter	GS250	0	1	0	1	1	1	1	1	0	0	0	0	0	0	0	0	0	0	0	0	0	0	0	0
	↓	GS251	1	1	0	1	1	1	1	1	0	0	0	0	0	0	0	0	0	0	0	0	0	0	0	0
	Red	GS252	X	X	1	1	1	1	1	1	0	0	0	0	0	0	0	0	0	0	0	0	0	0	0	0
Gray Scale of Green	Black	GS0	0	0	0	0	0	0	0	0	0	0	0	0	0	0	0	0	0	0	0	0	0	0	0	0
	↑	GS1	0	0	0	0	0	0	0	0	1	0	0	0	0	0	0	0	0	0	0	0	0	0	0	0
	Darker	GS2	0	0	0	0	0	0	0	0	0	1	0	0	0	0	0	0	0	0	0	0	0	0	0	0
	↑	↓					↓								↓									↓		
	↓	↓					↓								↓									↓		
	Brighter	GS250	0	0	0	0	0	0	0	0	0	1	0	1	1	1	1	1	0	0	0	0	0	0	0	0
	↓	GS251	0	0	0	0	0	0	0	0	1	1	0	1	1	1	1	1	0	0	0	0	0	0	0	0
	Green	GS252	0	0	0	0	0	0	0	0	X	X	1	1	1	1	1	1	0	0	0	0	0	0	0	0
Gray Scale of Blue	Black	GS0	0	0	0	0	0	0	0	0	0	0	0	0	0	0	0	0	0	0	0	0	0	0	0	0
	↑	GS1	0	0	0	0	0	0	0	0	0	0	0	0	0	0	0	0	1	0	0	0	0	0	0	0
	Darker	GS2	0	0	0	0	0	0	0	0	0	0	0	0	0	0	0	0	0	1	0	0	0	0	0	0
	↑	↓					↓								↓									↓		
	↓	↓					↓								↓									↓		
	Brighter	GS250	0	0	0	0	0	0	0	0	0	0	0	0	0	0	0	0	0	1	0	1	1	1	1	1
	↓	GS251	0	0	0	0	0	0	0	0	0	0	0	0	0	0	0	0	1	1	0	1	1	1	1	1
	Blue	GS252	0	0	0	0	0	0	0	0	0	0	0	0	0	0	0	0	X	X	1	1	1	1	1	1

0 : Low level voltage, 1 : High level voltage. X :Don't care.

Each basic color can be displayed in 253 gray scales from 8 bit data signals. According to the combination of total 24 bit data signals, the 16-million-color display can be achieved on the screen.

9. Optical Characteristics

Ta=25 , Vcc =+5.0V

Parameter		Symbol	Condition	Min.	Typ.	Max.	Unit	Remark
Viewing angle range	Vertical	11	CR 5	T.B.D	(60)	-	Deg.	【Note1,4】
		12		T.B.D	(80)	-	Deg.	
	Horizontal	21, 22		T.B.D	(80)	-	Deg.	
	Vertical	11	CR 10	T.B.D	(50)	-	Deg.	
		12		T.B.D	(70)	-	Deg.	
	Horizontal	21, 22		T.B.D	(70)	-	Deg.	
Contrast ratio		C R	=0 °	(300)	(400)	-		【Note2,4】
Response Time		d + r		-	16	-	ms	【Note3,4】
Chromaticity of White		x		(0.283)	(0.313)	(0.343)		【Note4】
		y		(0.299)	(0.329)	(0.359)		
Chromaticity of Red		x		(0.605)	(0.635)	(0.665)		
		y		(0.307)	(0.337)	(0.367)		
Chromaticity of Green		x		(0.257)	(0.287)	(0.317)		
		y		(0.573)	(0.603)	(0.633)		
Chromaticity of Blue		x		(0.114)	(0.144)	(0.174)		
		y		(0.056)	(0.086)	(0.116)		
Luminance of white		YL		(240)	(300)	-	cd/m ²	I _L =(6.5)mA rms f _L =(60)kHz 【Note4】
White Uniformity		w		-	-	(1.33)	-	【Note5】
TCO03 A2.3.4		w2		-	-	(1.7)		
Cross Talk		Dsha		-	-	2.0	%	【Note6】
Curve		V0	=0 °	-	T.B.D	-	%	
		V36		-	T.B.D	-	%	
		V73		-	T.B.D	-	%	
		V109		-	T.B.D	-	%	
		V146		-	T.B.D	-	%	
		V182		-	T.B.D	-	%	
		V219		-	T.B.D	-	%	
V255	-	T.B.D	-	%				

The measurement shall be executed 30 minutes after lighting at rating.

The optical characteristics shall be measured in a dark room or equivalent state with the method shown in Fig.2 below.

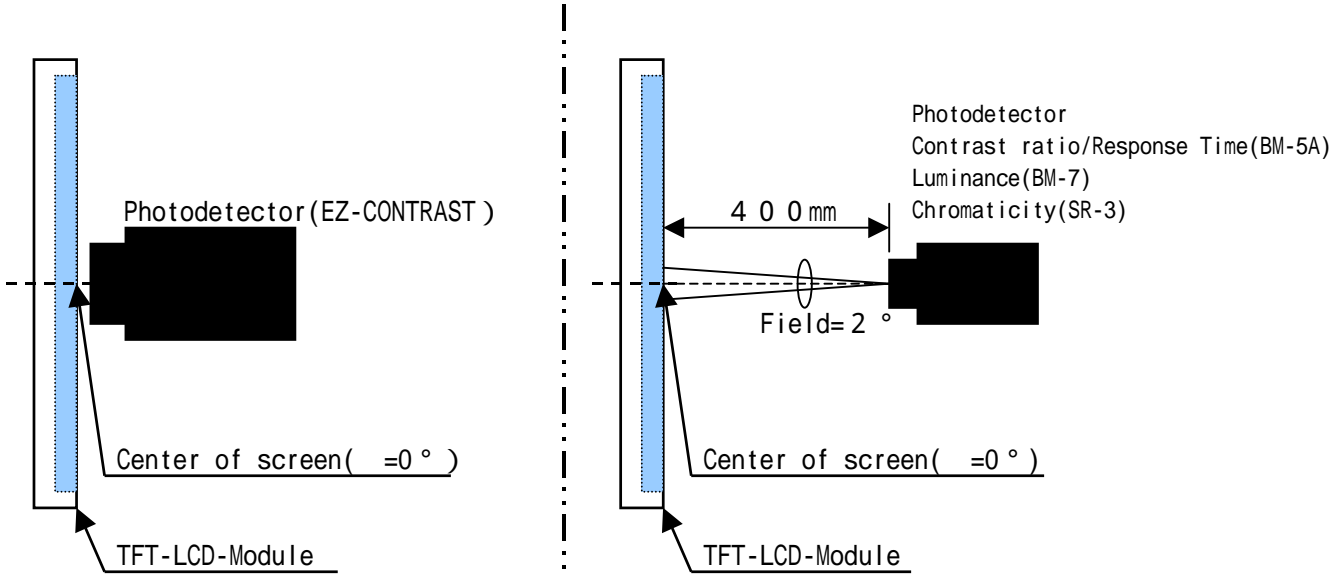
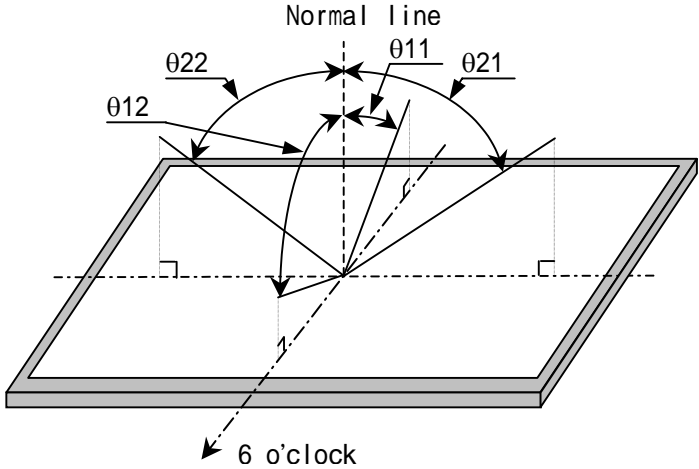

Fig2-1 Viewing angle measurement method

Fig2-2 Luminance/Contrast ratio/Response time/Chromaticity measurement method

Fig2 Optical characteristics measurement method

【Note1】 Definitions of viewing angle range:



【Note2】 Definition of contrast ratio:

The contrast ratio is defined as the following.

$$\text{Contrast Ratio (CR)} = \frac{\text{Luminance (brightness) with all pixels white}}{\text{Luminance (brightness) with all pixels black}}$$

【Note3】 Definition of response time:

The response time is defined as the following figure and shall be measured by switching the input signal for "black" and "white".

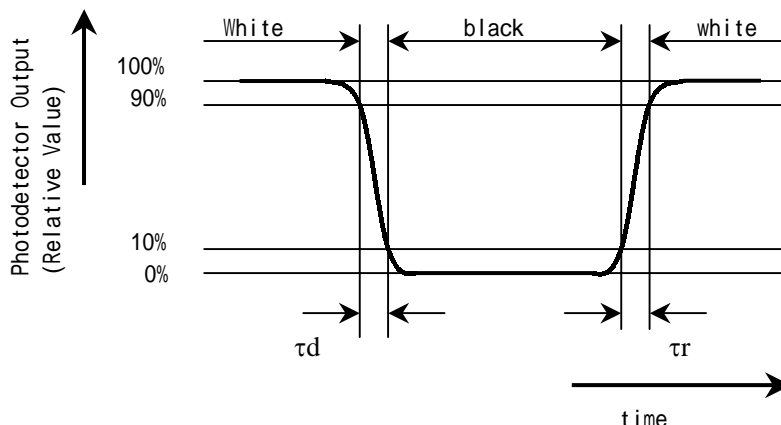

【Note4】 This shall be measured at center of the screen.

【Note5】 Definition of white uniformity:

White uniformity is defined as the following with nine measurements (A ~ I).

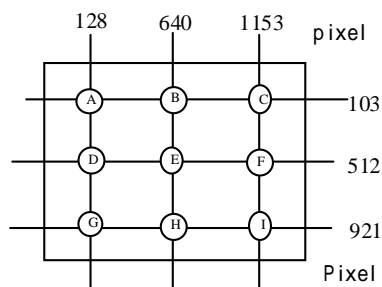

$$w1 = \frac{\text{Maximum Luminance of nine points (brightness)}}{\text{Minimum Luminance of nine points (brightness)}}$$

【Note6】 Definition of corss talk:

We measured luminance in case there are a window frame and in case there are not a window frame with X points of the following figure. Then, we compared the measured values.

$$Dsha(\%) = \frac{|\text{Luminance with a window frame} - \text{Luminance without a window}|}{\text{Luminance without a window}} \times 100$$

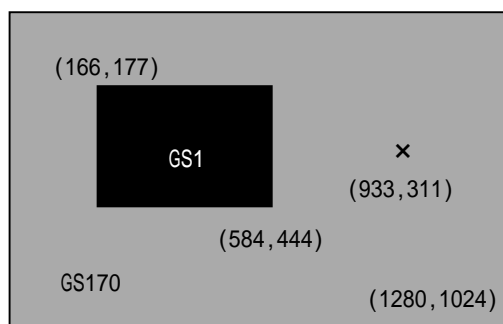

10. Mechanical characteristics

Parameter		Min.	Typ.	Max.	Unit
Mounting part	Tighten torque	T.B.D	T.B.D	T.B.D	N · m
		T.B.D	T.B.D	T.B.D	(kgf · cm)
	Re-screw times	-	-	(5)	times

11. Handling Precautions

- a) Be sure to turn off the power supply when inserting or disconnecting the cable.
- b) Be sure to design the cabinet so that the module can be installed without any extra stress such as warp or twist.
- c) Since the front polarize is easily damaged, pay attention not to scratch it.
- d) Since long contact with water may cause discoloration or spots, wipe off water drop immediately.
- e) When the panel surface is soiled, wipe it with absorbent cotton or other soft cloth.
- f) Since the panel is made of glass, it may break or crack if dropped or bumped on hard surface. Handle with care.
- g) Since CMOS LSI is used in this module, take care of static electricity and take the human earth into consideration when handling.
- h) Make sure the four mounting holes of the module are grounded sufficiently. Take electro-magnetic interference (EMI) into consideration.
- i) The module has some printed circuit boards (PCBs) on the back side. Take care to keep them from any stress or pressure when handling or installing the module; otherwise some of electronic parts on the PCBs may be damaged.
- j) Observe all other precautionary requirements in handling components.
- k) When some pressure is added onto the module from rear side constantly, it causes display non-uniformity issue, functional defect, etc. So, please avoid such design.
- l) When handling LCD modules and assembling them into cabinets, please be noted that long-term storage in the environment of oxidization or deoxidization gas and the use of such materials as reagent, solvent, adhesive, resin, etc. which generate these gasses, may cause corrosion and discoloration of the LCD modules.

12. Packing form

- a) Piling number of cartons : T.B.D
- b) Packing quantity in one carton : T.B.D
- c) Carton size : T.B.D
- d) Total mass of one carton filled with full modules : T.B.D
- e) Packing form : T.B.D

13 . Reliability test items

No	Test item	Conditions
1	High temperature storage test	Ta = 60 240h
2	Low temperature storage test	Ta = -25 240h
3	High temperature & high humidity operation test	Ta = 40 ; 95%RH 240h (No condensation)
4	High temperature operation test	Ta = 50 240h (The panel temp. must be less than 60)
5	Low temperature operation test	Ta = 0 240H
6	Vibration test (non- operating)	Waveform : Sine wave Frequency : 10 ~ 57Hz/Vibration width (one side) : 0.075mm : 58 ~ 500Hz/Gravity : 9.8m/s ² Sweep time : 11minutes Test period : 3 hours (1 hour for each direction of X,Y,Z)
7	Shock test (non- operating)	Max. gravity : 490m/s ² Pulse width : 11ms, sine wave Direction : ± X, ± Y, ± Z, once for each direction.
8	Thermal shock test (Storage)	Ta=-25 ~ 60 ; 5 cycles Test period : 10 hours (1 hour for each temperature)
9	Altitude	Ta=50 ,70kPa,3,048m(10,000ft), t=24h (Operating) Ta=70 ,12kPa,15,240m(50,000ft), t=24h (Storage)

【Result Evaluation Criteria】

Under the display quality test conditions with normal operation state, these shall be no change which may affect practical display function.

14 . Others

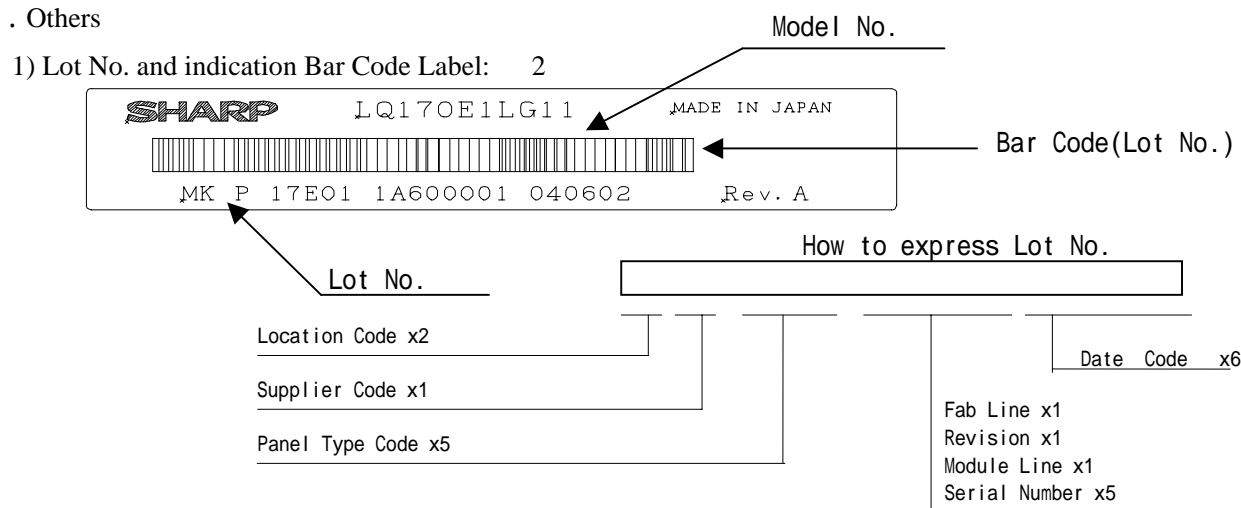

2) Packing Label

社内品番 : (4 S) LQ170E1LG11	
Bar code ()	
LotNO. :	(1 T) 2 0 0 4 . X . X X
Bar code ()	
Quantity :	(Q) p c s
Bar code ()	
ユーザ品番 :	
シャープ物流用ラベルです。	

Model No. (LQ170E1LG11)

Lot No. (Date)

Quantity

3) Adjusting volume have been set optimally before shipment, so do not change any adjusted value.

If adjusted value is changed, the specification may not be satisfied.

4) Disassembling the module can cause permanent damage and should be strictly avoided.

5) Please be careful since image retention may occur when a fixed pattern is displayed for a long time.

6) The chemical compound which causes the destruction of ozone layer is not being used.

7) Cold cathode fluorescent lamp in LCD PANEL contains a small amount of mercury, Please follow local ordinances or regulations for disposal.

<p>COLD CATHODE FLUORESCENT LAMP IN LCD PANEL CONTAINS A SMALL AMOUNT OF MERCURY, PLEASE FOLLOW LOCAL ORDINANCES OR REGULATIONS FOR DISPOSAL 当該液晶ディスプレイパネルは蛍光管が組み込まれていますので、地方自治体の条 例、または、規則に従って廃棄ください。</p>
--

8) When any question or issue occurs, it shall be solved by mutual discussion.

15. Carton storage condition

Temperature 0 to 40

Humidity 95%RH or less

Reference condition : 20 to 35 , 85%RH or less (summer)

: 5 to 15 , 85%RH or less (winter)

• the total storage time (40 ,95%RH) : 240H or less

Sunlight Be sure to shelter a product from the direct sunlight.

Atmosphere Harmful gas, such as acid and alkali which bites electronic components and/or wires must not be detected.

Notes Be sure to put cartons on palette or base, don't put it on floor, and store them with removing from wall

Please take care of ventilation in storehouse and around cartons, and control changing temperature is within limits of natural environment

Storage period 1 year

