

# SHINDENGEN

## Sidac

**K1V12**

### OUTLINE DIMENSIONS

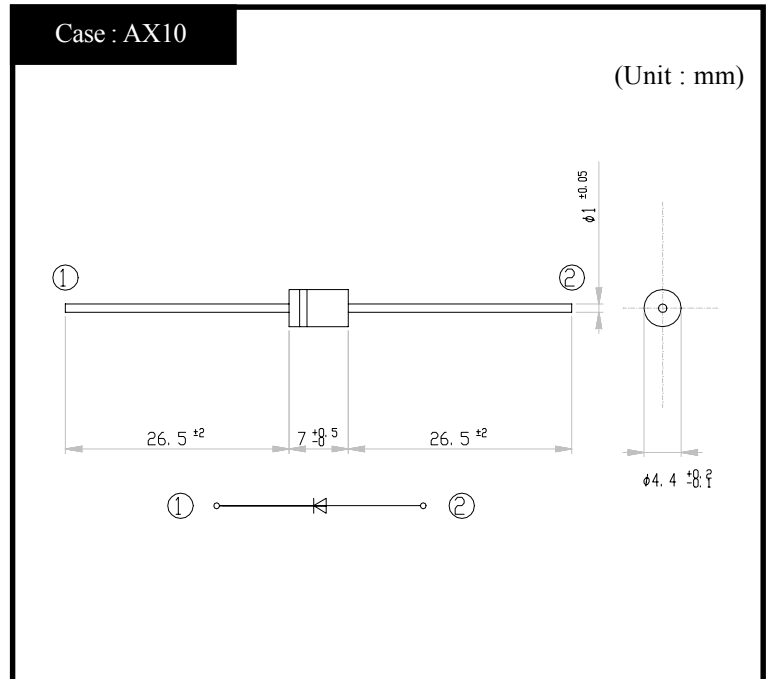

### RATINGS

#### ● Absolute Maximum Ratings

Item	Symbol	Conditions	Ratings	Unit
Storage Temperature	$T_{stg}$		-40~125	°C
Operating Junction Temperature	$T_j$		125	°C
Maximum Off-state Voltage	$V_{DRM}$		90	V
RMS On-state Current	$I_T$	$T_l = 112^{\circ}C$ , 50Hz sine wave ( $\theta = 180^{\circ}$ )	1	A
Surge On-state Current	$I_{TSM}$	$T_j = 25^{\circ}C$ , 50Hz sine wave ( $\theta = 180^{\circ}$ ), non-repetitive 1-cycle peak value	20	A
Pulse On-state Current	$I_{TRM}$	$T_a = 25^{\circ}C$ , pulse width $t_o = 10 \mu s$ , sine wave, repetitive peak value $f = 1 kHz$	25	A
		$T_a = 25^{\circ}C$ , pulse width $t_o = 10 \mu s$ , sine wave, repetitive peak value $f = 60 Hz$	80	
Critical Rate of Rise of On-state Current	$di_T/dt$		80	A/ $\mu s$

#### ● Electrical Characteristics ( $T_l=25^{\circ}C$ )

Item	Symbol	Conditions	Ratings	Unit
Breakover Voltage	$V_{BO}$	$I_B = 0$ , 50Hz sine wave	110~125	V
Off-state Current	$I_{DRM}$	$V_D = V_{DRM}$	Max 10	$\mu A$
Breakover Current	$I_{BO}$		Max 0.5	mA
Holding Current	$I_H$		TYP 50	mA
On-state Voltage	$V_T$	$I_T = 1A$	Max 1.5	V
Switching Resistance	$R_S$		Min 0.1	k $\Omega$
Thermal Resistance	$\theta_{jl}$	Junction to lead	Max 15	°C/W

#### ● Standard Design with P.C.B.

Item	Symbol	Conditions	Standard	Unit
RMS On-state Current	$I_T$	Assembled in P.C.B., $T_a = 25^{\circ}C$ , soldering land 3mm $\phi$	1.2	A

K1V10  
K1V11  
K1V12

Typical On-State Voltage

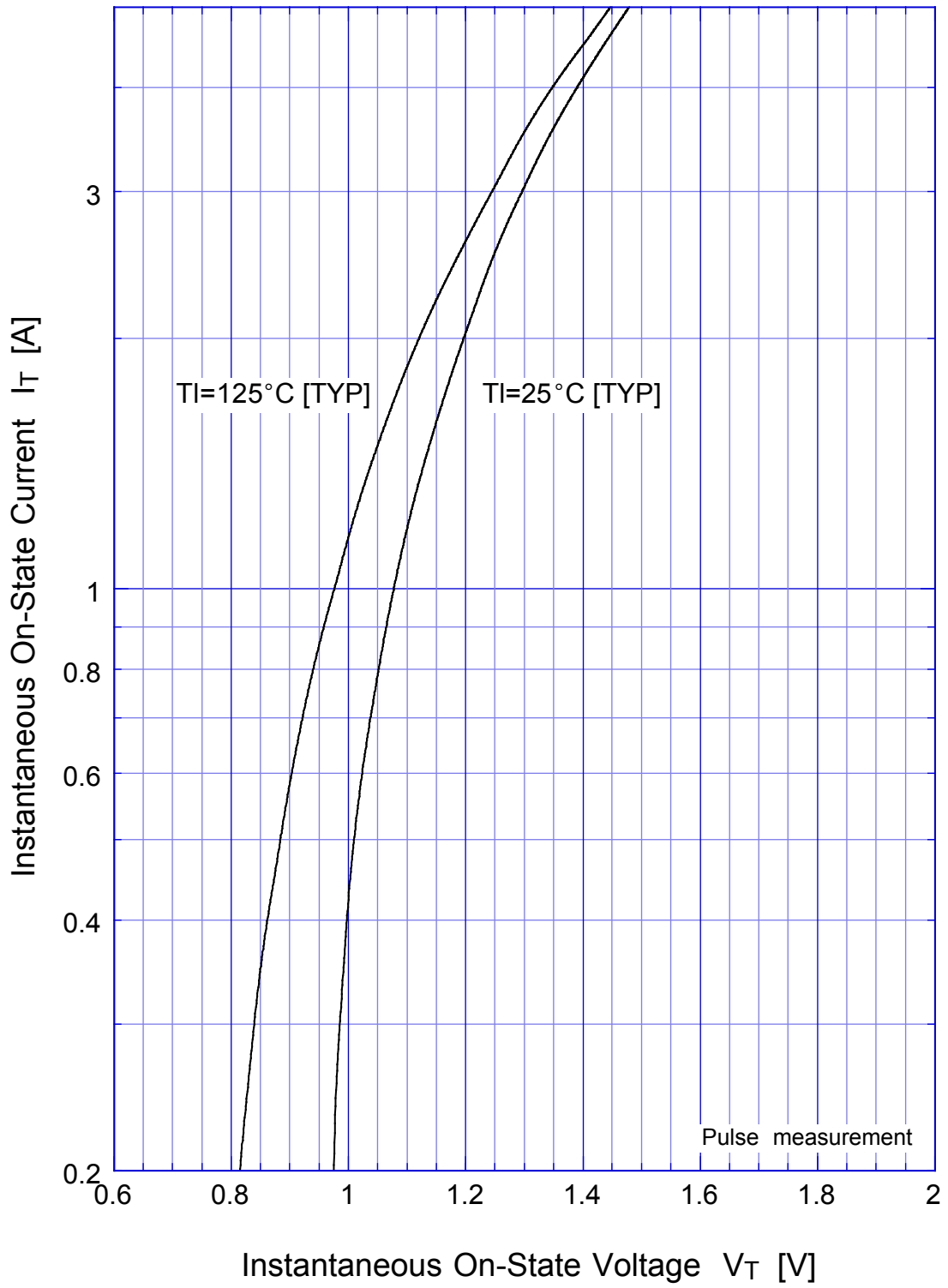

K1V10  
K1V11  
K1V12

Power Dissipation

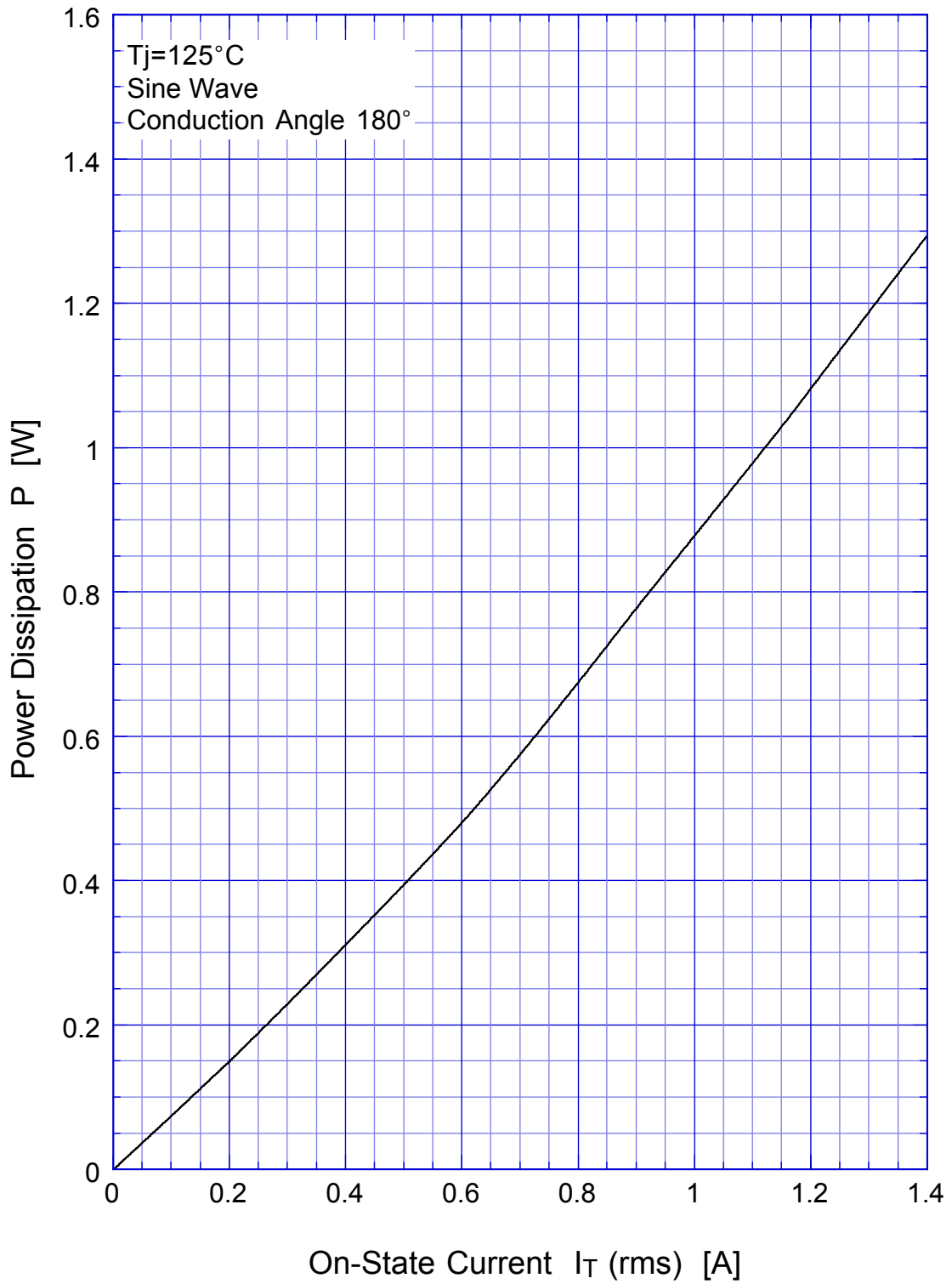

K1V10

K1V11

K1V12

Maximum Lead Temperature

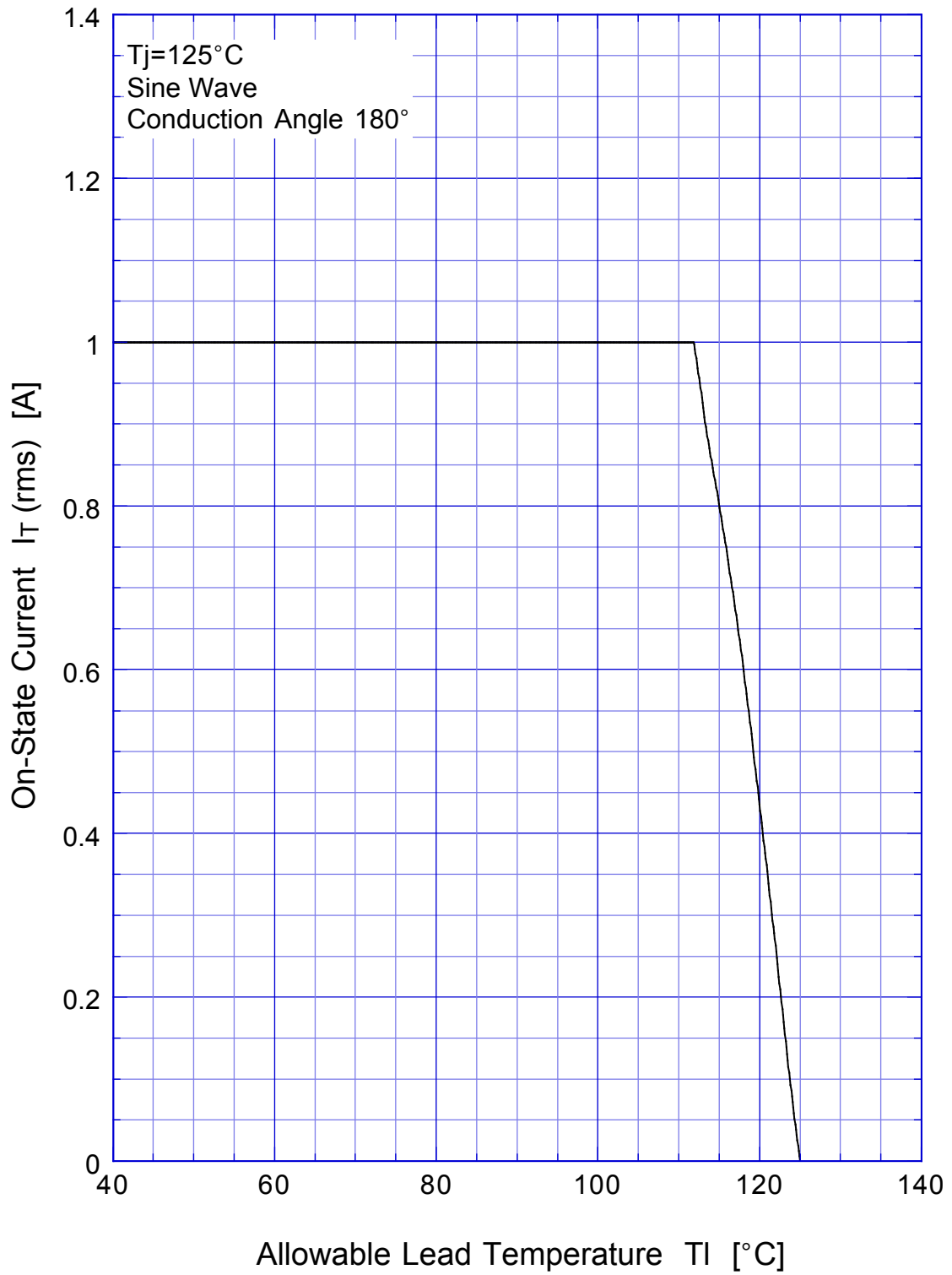

K1V10

K1V11

K1V12

Maximum Ambient Temperature

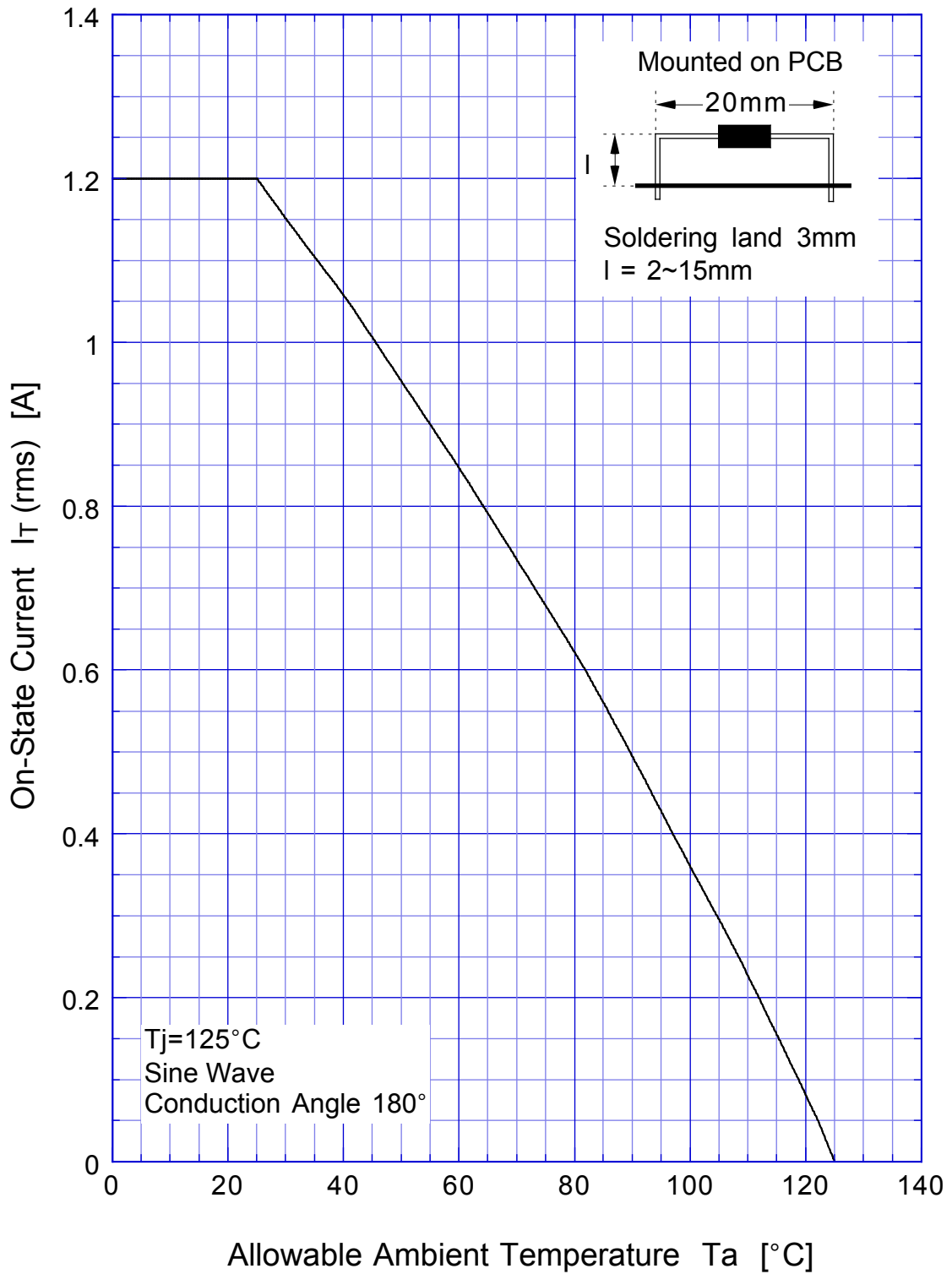

K1V10  
K1V11  
K1V12

Maximum Surge On-State Current

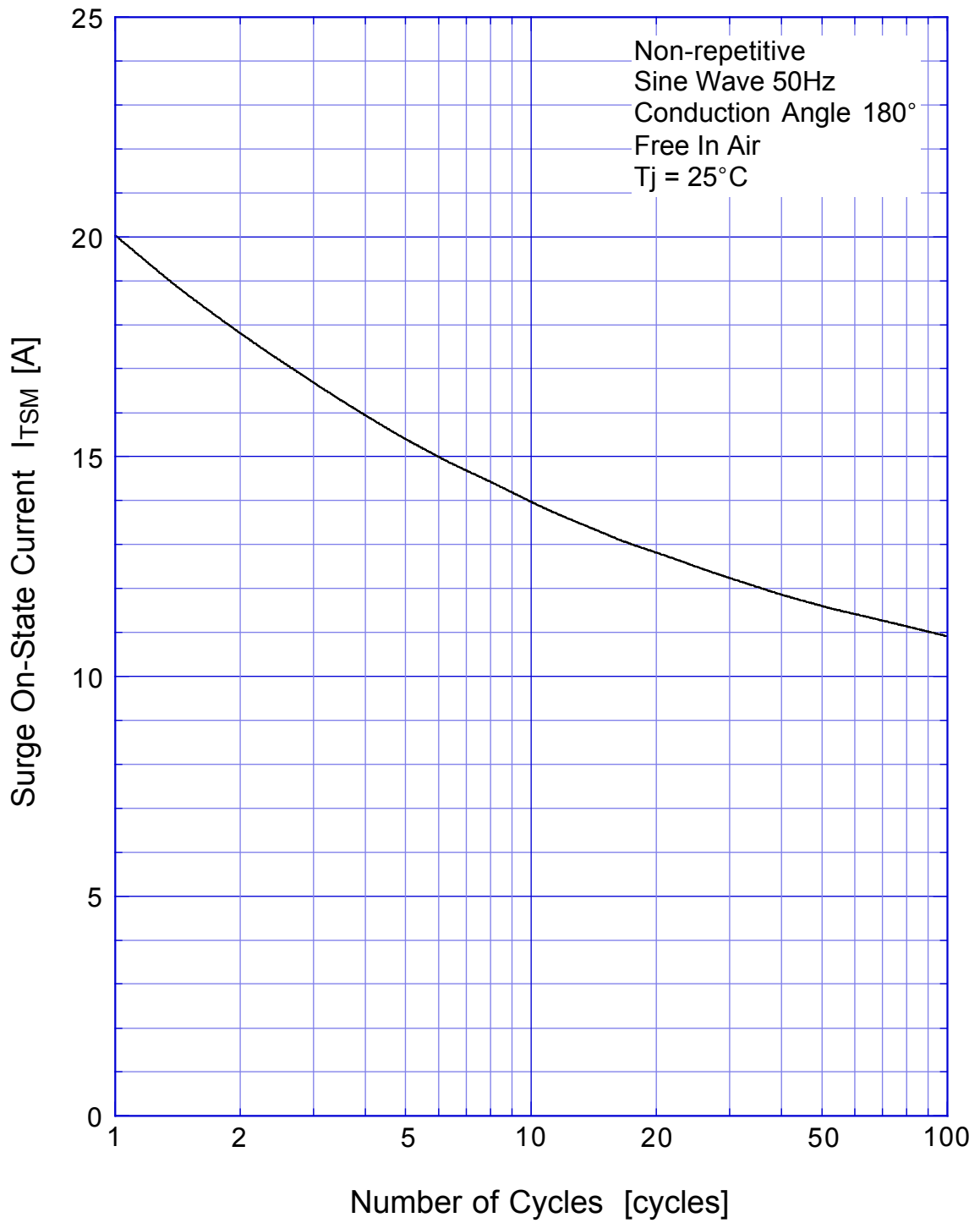

K1V10  
K1V11  
K1V12

### Pulse On-State Current Rating

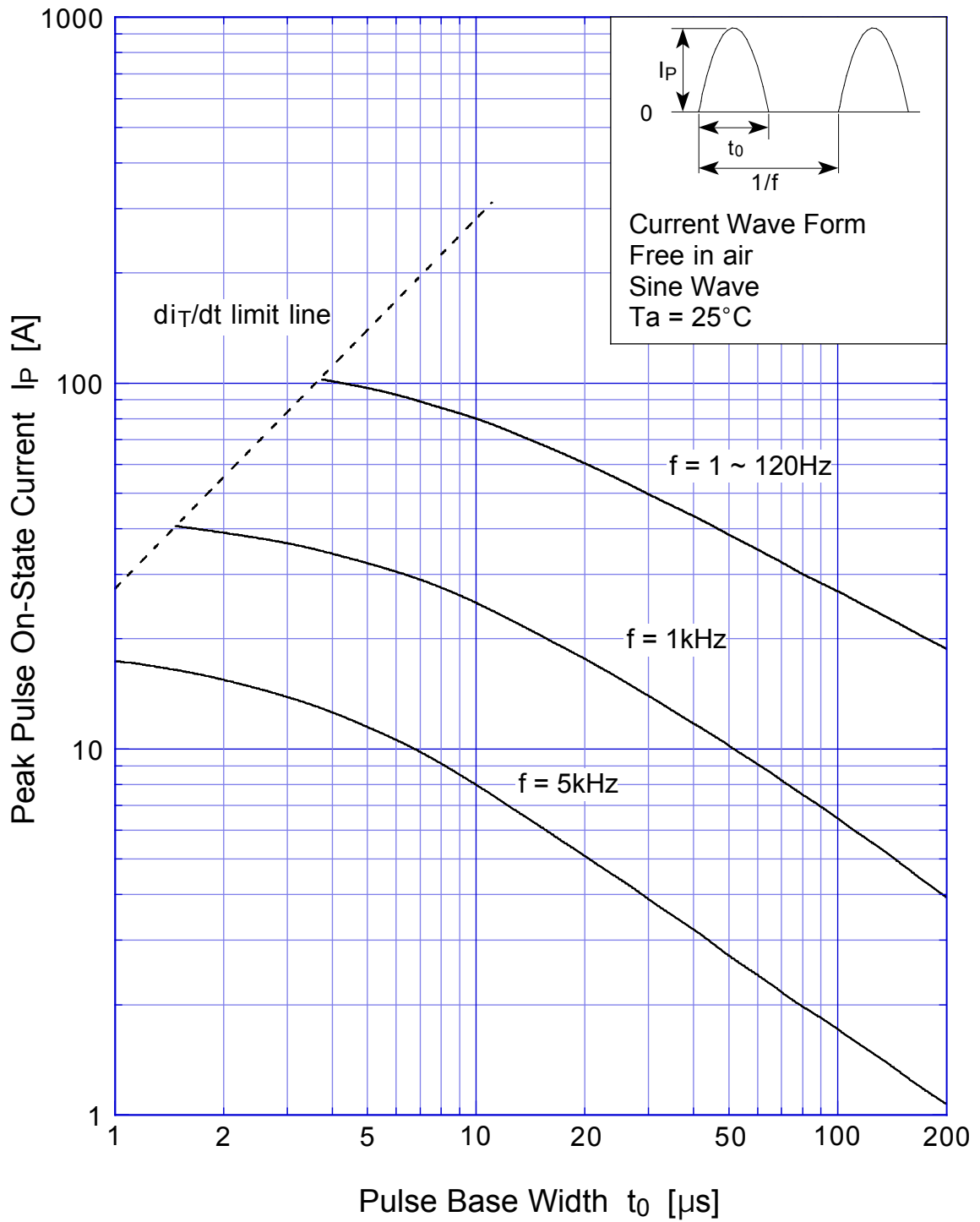

K1V10  
K1V11  
K1V12

### Pulse On-State Current Derating

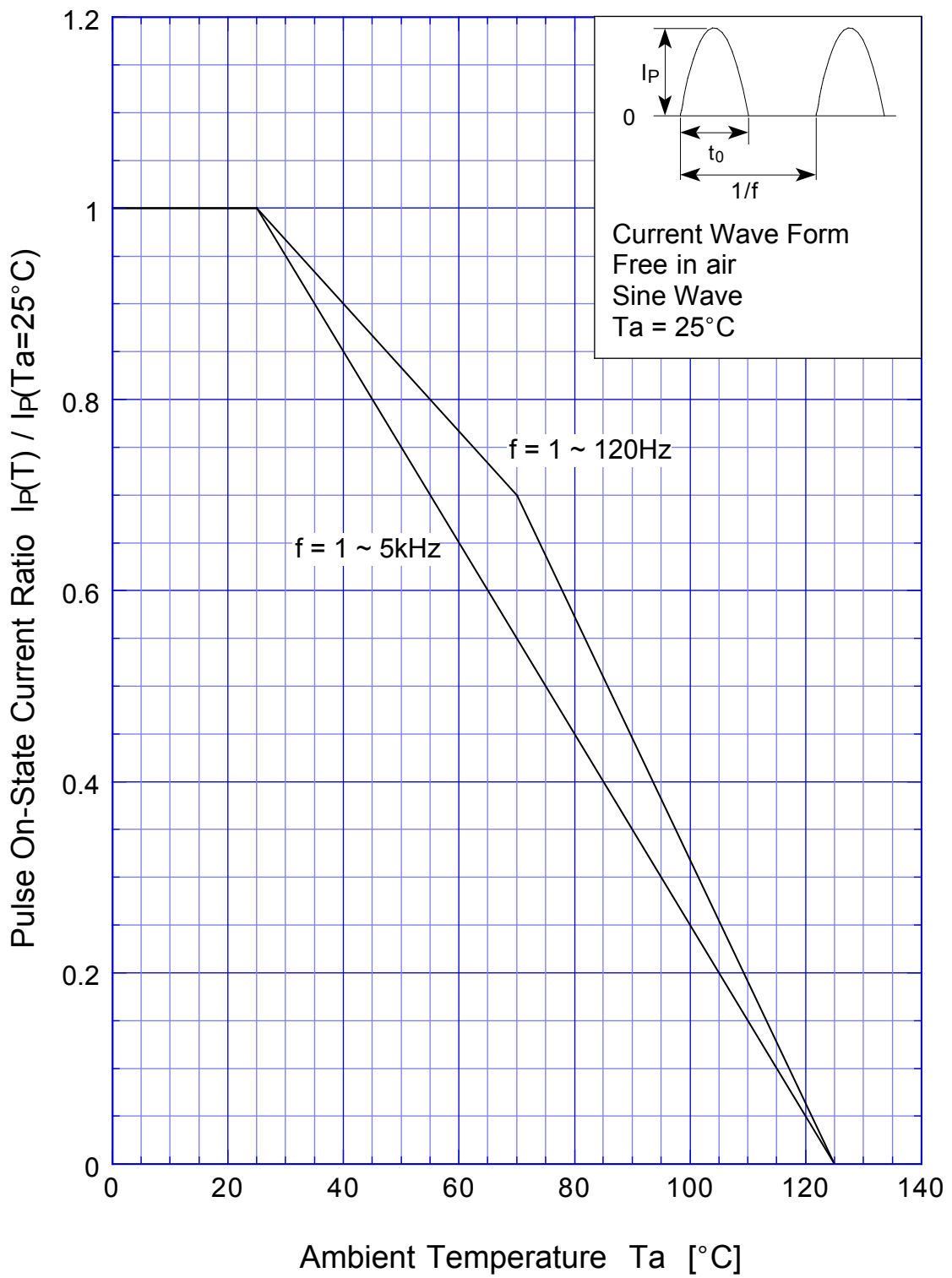



K1V10  
K1V11  
K1V12

Transient Thermal Resistance

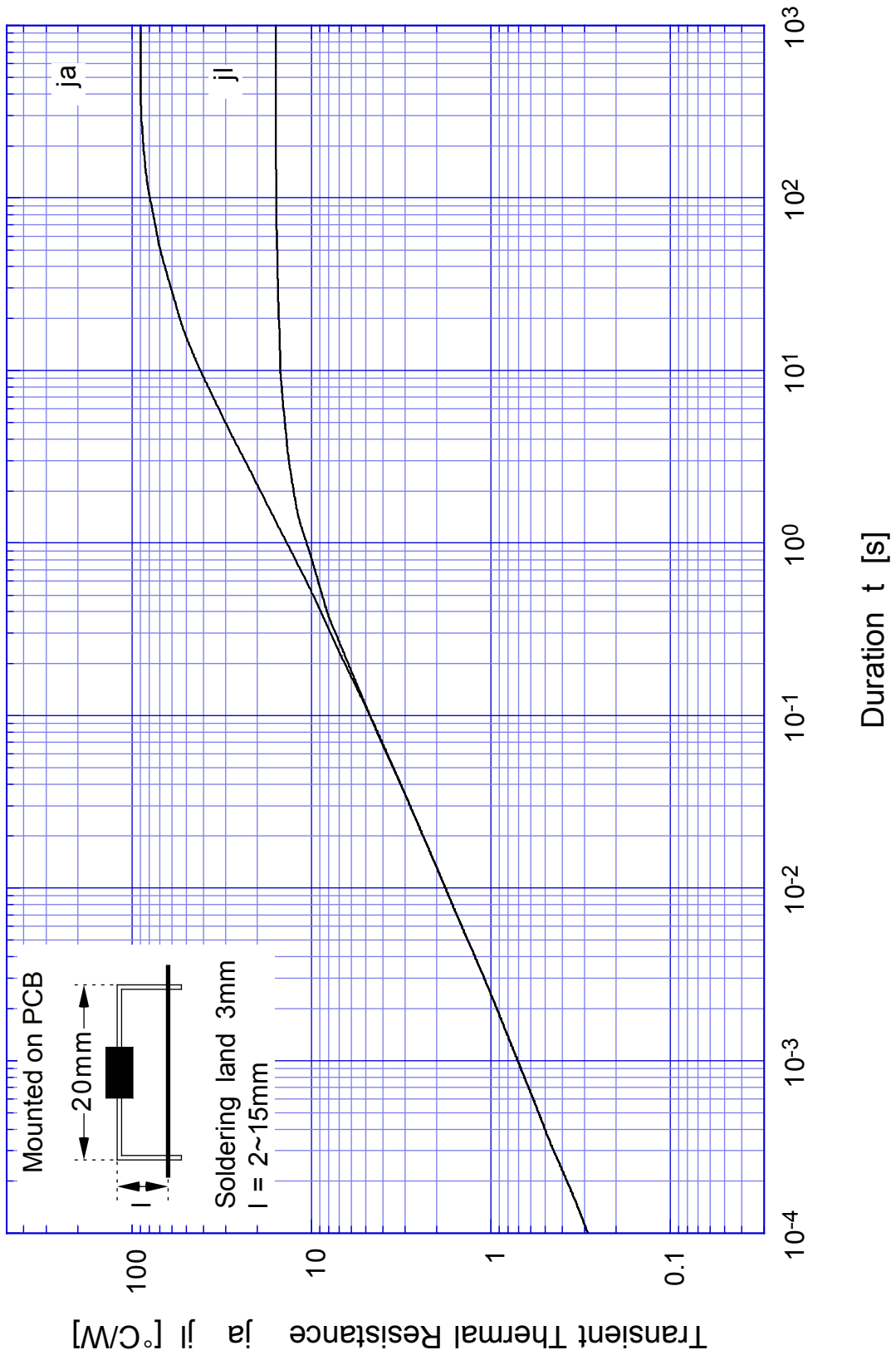

K1V10  
K1V11  
K1V12

Breakover Voltage - Junction Temperature

