

# HFS34(JG-34F)

# SOLID STATE RELAY



File No: E134517



File No.: J50061405



### Features

- 4000V dielectric strength
- Photo isolation
- Zero cross or random turn-on
- Removable finger proof cover available
- Double SCR AC output
- Panel mount
- DC or AC control
- RoHS compliant

### INPUT (TA = 25°C)

Control voltage range (DC input)	3 to 32VDC (Without LED) 4 to 32VDC (With LED)
Control voltage range (AC input)	90 to 280VAC
Must operate voltage (DC input)	3VDC
Must operate voltage (AC input)	90VAC
Must release voltage (DC input)	1VDC
Must release voltage (AC input)	10VAC
Max. input current (DC input)	25mA
Max. reverse protection voltage (DC input)	-32VDC

### OUTPUT (TA = 25°C)

Type	D -240□	D -380□	D -480□
Load voltage range	48 to 280 VAC	48 to 440 VAC	48 to 530 VAC
Max. transient voltage	600Vpk	800Vpk	1200Vpk
Max. leakage current	5mA	5mA	5mA
Max. on-state voltage drop	1.7Vrms		
Load current	40A, 50A, 60A, 70A, 80A, 100A		
Max. surge current (10ms)	10 times of rated current		
Min. power factor	0.5		
Max. turn-on time	Random turn-on (DC input) : 1ms		
	Zero cross turn-on (DC input) : 1/2 cycle + 1ms		
	AC input type : 20ms		
Max turn-off time	(DC input)	1/2 cycle + 1ms	
	(AC input)	40ms	
Min. off-state dv/dt	500V/μs		

### GENERAL (TA = 25°C)

Dielectric strength (at 50/60Hz, 1min)		4000VAC (input to output) 2500VAC (input, output to base)
Insulation resistance		1000MΩ (at 500VDC)
Ambient temperature	Operating	-30°C to 80°C
	Storage	-30°C to 100°C
Ambient humidity		45% to 85% RH
Unit weight		Approx. 88g

### DESCRIPTION

The HFS34 offer 3 to 32VDC or 90 to 280VAC input control, with outputs rated at 40A, 50A, 60A, 70A, 80A or 100A. SCR output provides high dv/dt capability more than 500V/us. All models include an internal snubber. The relays provide 4000VAC opto-isolation between input and output. Outline dimension is 58.4mmX45.7mmX22.9mm.

### PRECAUTIONS

1. When choosing a SSR, please notice the actual load current and working ambient temperature. To use the SSR correctly, please refer to CHARACTERISTIC DATA and make sure the heat sink size when it works in full load current.
2. Apply heat-radiation silicon grease of a heat conductive sheet between the SSR and heat sink. There will be a space between the SSR and heat sink Attached to the SSR. Therefore, the generated heat of the SSR cannot be radiated properly without the grease. As a result, the SSR may be overheated and damaged or deteriorated.
3. Tighten the SSR terminal screws properly. If the screws are not tight, the SSR will be Damaged by heat generated when the power in ON. Perform wiring using the tightening torque shown in the following table.

Screw size	Recommended tightened torque
M3	0.58 to 0.98 N·m
M4	0.98 to 1.37 N·m



HONGFA RELAY

ISO9001、ISO/TS16949、ISO14001、OHSAS18001 CERTIFIED

2007 Rev. 1.00

## ORDERING INFORMATION

Type	HFS34 / D- 240 A 40 Z S -L (XXX)						
Input voltage	D: 3 to 32VDC (Without LED) 4 to 32VDC (With LED) A: 90 to 280VAC						
Load voltage	240: 48 to 280V 380: 48 to 400V 480: 48 to 530V						
Load voltage form	A: AC						
Load current	40: 40A 50: 50A 60: 60A 70: 70A 80: 80A 100: 100A						
Zero cross function	Z: Zero cross turn-on P: Random turn-on						
Output component	S: SCR						
LED indicator	L: With LED(Unavailable for AC input type) Nil: Without LED						
Customer special code	Only for special requirements, e.g. (555) stands for RoHS compliant						

Notes: HFS34 is an environmental friendly product, please mark special code (555) when order.

## OUTLINE DIMENSIONS, WIRING DIAGRAM AND MOUNTING HOLES

Unit: mm

Outline Dimensions

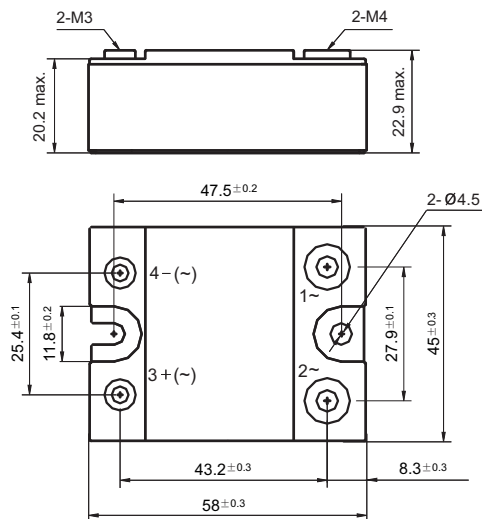

Mounting Hole Layout

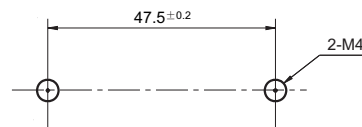

Wiring Diagram

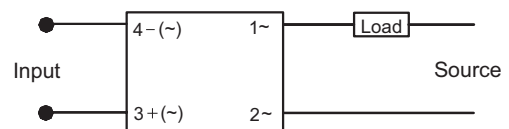

## CHARACTERISTIC CURVES

Max. Load Current vs. Ambient Temp. (40A)

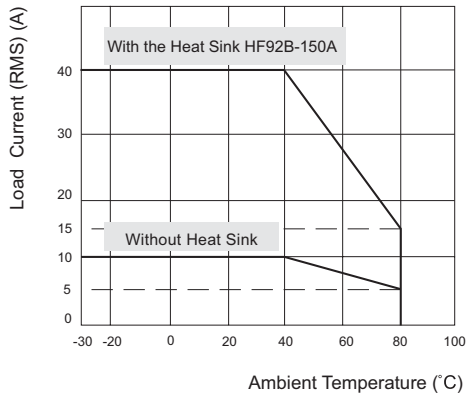

Max. Load Current vs. Ambient Temp. (50A)

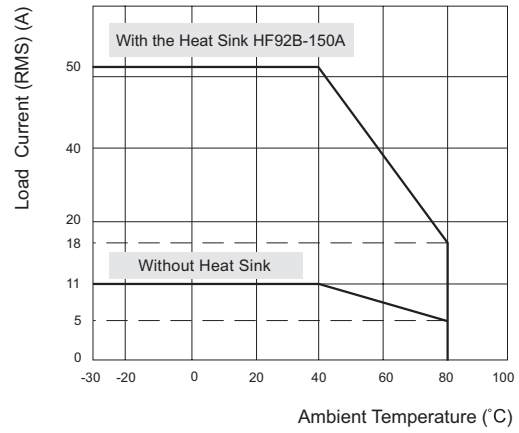

Max. Load Current vs. Ambient Temp. (60A)

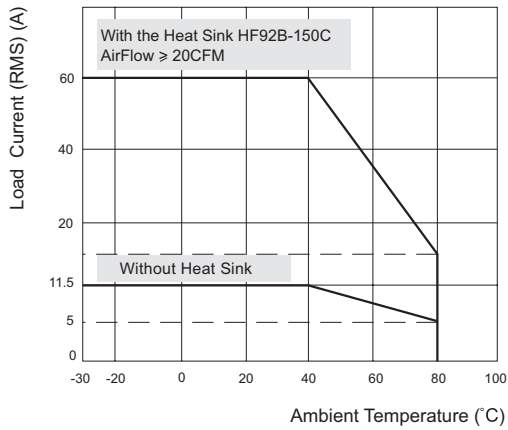

Max. Load Current vs. Ambient Temp. (70A)

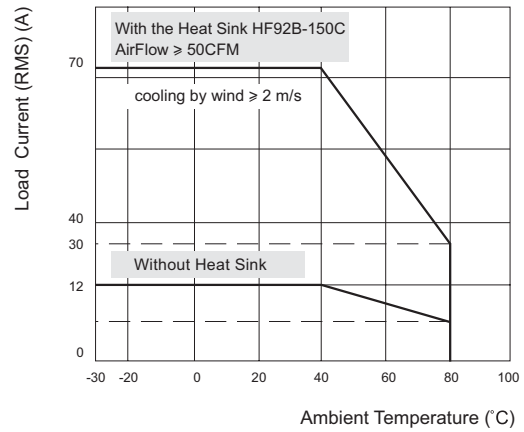

Max. Load Current vs. Ambient Temp. (80A)

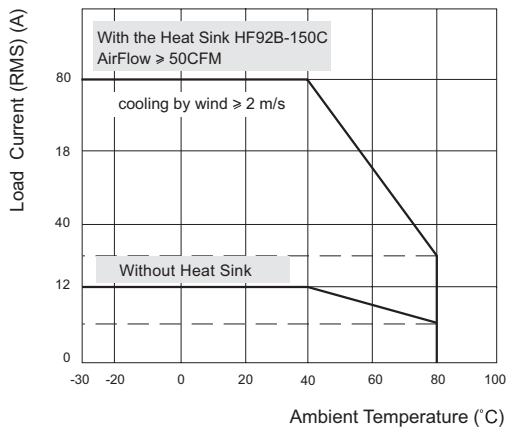

Max. Load Current vs. Ambient Temp. (100A)

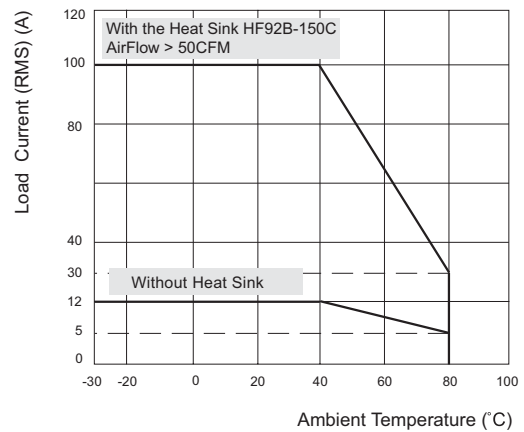

### Disclaimer

This datasheet is for the customers' reference. All the specifications are subject to change without notice.

We could not evaluate all the performance and all the parameters for every possible application. Thus the user should be in a right position to choose the suitable product for their own application. If there is any query, please contact Hongfa for the technical service. However, it is the user's responsibility to determine which product should be used only.