



Design Example Report

Title	<i>20W Dual Output Power Supply using TOP247Y</i>
Specification	Input: 85-265 VAC Output: 12V/1.25A, -14V/0.4A
Application	Cooking Range
Author	Power Integrations Applications Department
Document Number	DER-53
Date	April 20, 2005
Revision	1.0

Summary and Features

This document is an engineering prototype report describing a 20W power supply utilizing a TOP247Y. This power supply will be used in a cook top application where the maximum ambient temperature can reach 105C.

- 105C Ambient Operation
- TOP247Y operates at 66kHz to reduce switching losses and EMI filter size
- Compact PCB 7" X 3"
- High efficiency >85% at full load

The products and applications illustrated herein (including circuits external to the products and transformer construction) may be covered by one or more U.S. and foreign patents or potentially by pending U.S. and foreign patent applications assigned to Power Integrations. A complete list of Power Integrations' patents may be found at www.powerint.com.

Table Of Contents

1	Introduction.....	4
2	Power Supply Specification.....	5
3	Schematic.....	6
4	Circuit Description	7
4.1	Input EMI Filtering	7
4.2	TOPSwitch Primary.....	7
4.3	Output Rectification.....	7
4.4	Output Feedback.....	7
5	PCB Layout	9
6	Bill Of Materials	10
7	Transformer Specification.....	12
7.1	Electrical Diagram	12
7.2	Electrical Specifications.....	12
7.3	Materials.....	12
7.4	Transformer Build Diagram	13
7.5	Transformer Construction.....	13
7.6	Bobbin Drawing.....	14
7.7	Transformer Spreadsheets.....	15
8	Performance Data	17
8.1	Efficiency.....	17
8.2	Minimum Load Input Power.....	17
8.3	Regulation	18
8.3.1	Load.....	18
8.3.2	Line	18
9	Thermal Performance.....	19
10	Waveforms.....	20
10.1	Drain Voltage and Current, Normal Operation	20
10.2	Output Voltage Start-up Profile	20
10.3	Drain Voltage and Current Start-up Profile.....	21
10.4	Load Transient Response (75% to 100% Load Step)	21
10.5	Output Ripple Measurements.....	22
10.5.1	Ripple Measurement Technique	22
10.5.2	Measurement Results	23
11	Control Loop Measurements.....	24
11.1	85 VAC Input.....	24
11.2	265 VAC Input.....	24
12	Conducted EMI	25
13	Revision History.....	26



Important Note:

Although this board is designed to satisfy safety isolation requirements, the engineering prototype has not been agency approved. Therefore, all testing should be performed using an isolation transformer to provide the AC input to the prototype board.

Design Reports contain a power supply design specification, schematic, bill of materials, and transformer documentation. Performance data and typical operation characteristics are included. Typically only a single prototype has been built.



1 Introduction

This document is an engineering prototype report describing a 20W power supply utilizing a TOP247Y. This power supply will be used in a cook top application where the maximum ambient temperature can reach 105C.

The document contains the power supply specification, schematic, bill-of-materials, transformer documentation, printed circuit layout, and performance data.

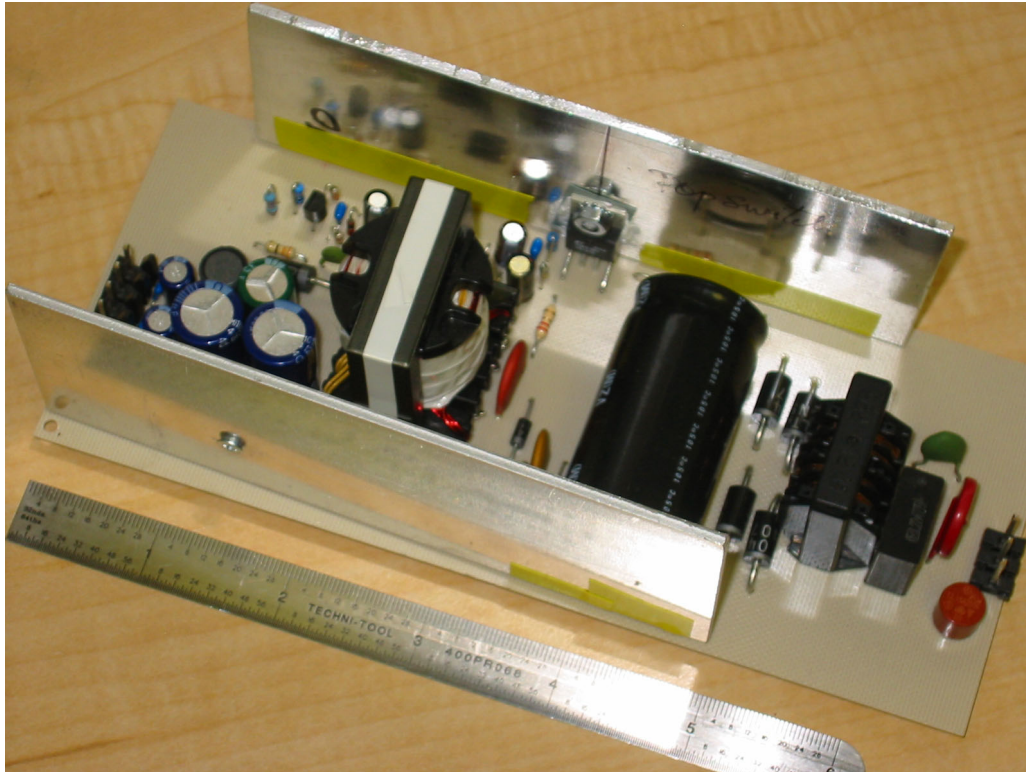

Figure 1 – Populated Circuit Board Photograph.



2 Power Supply Specification

Description	Symbol	Min	Typ	Max	Units	Comment
Input						
Voltage	V_{IN}	85		265	VAC	2 Wire – no P.E.
Frequency	f_{LINE}	47	50/60	64	Hz	
No-load Input Power (230 VAC)				0.3	W	
Output						
Output Voltage 1	V_{OUT1}		12		V	± 5% 20 MHz bandwidth
Output Ripple Voltage 1	$V_{RIPPLE1}$			50	mV	
Output Current 1	I_{OUT1}	0.25		1.25	A	± 10% 20 MHz bandwidth
Output Voltage 2	V_{OUT2}		-14		V	
Output Ripple Voltage 2	$V_{RIPPLE2}$			100	mV	
Output Current 2	I_{OUT2}	0.05		0.4	A	
Total Output Power						
Continuous Output Power	P_{OUT}			20.6	W	
Peak Output Power				40	W	
Efficiency	η		85		%	Measured at P_{OUT} (20.6 W), 25 °C
Environmental						
Conducted EMI			Meets CISPR22B / EN55022B			1.2/50 μ s surge, IEC 1000-4-5, Series Impedance: Differential Mode: 2 Ω Common Mode: 12 Ω
Safety			Designed to meet IEC950, UL1950 Class II			
Surge			TBD		kV	
Surge			TBD		kV	100 kHz ring wave, 500 A short circuit current, differential and common mode
Ambient Temperature	T_{AMB}	0		105	°C	Free convection, sea level



3 Schematic

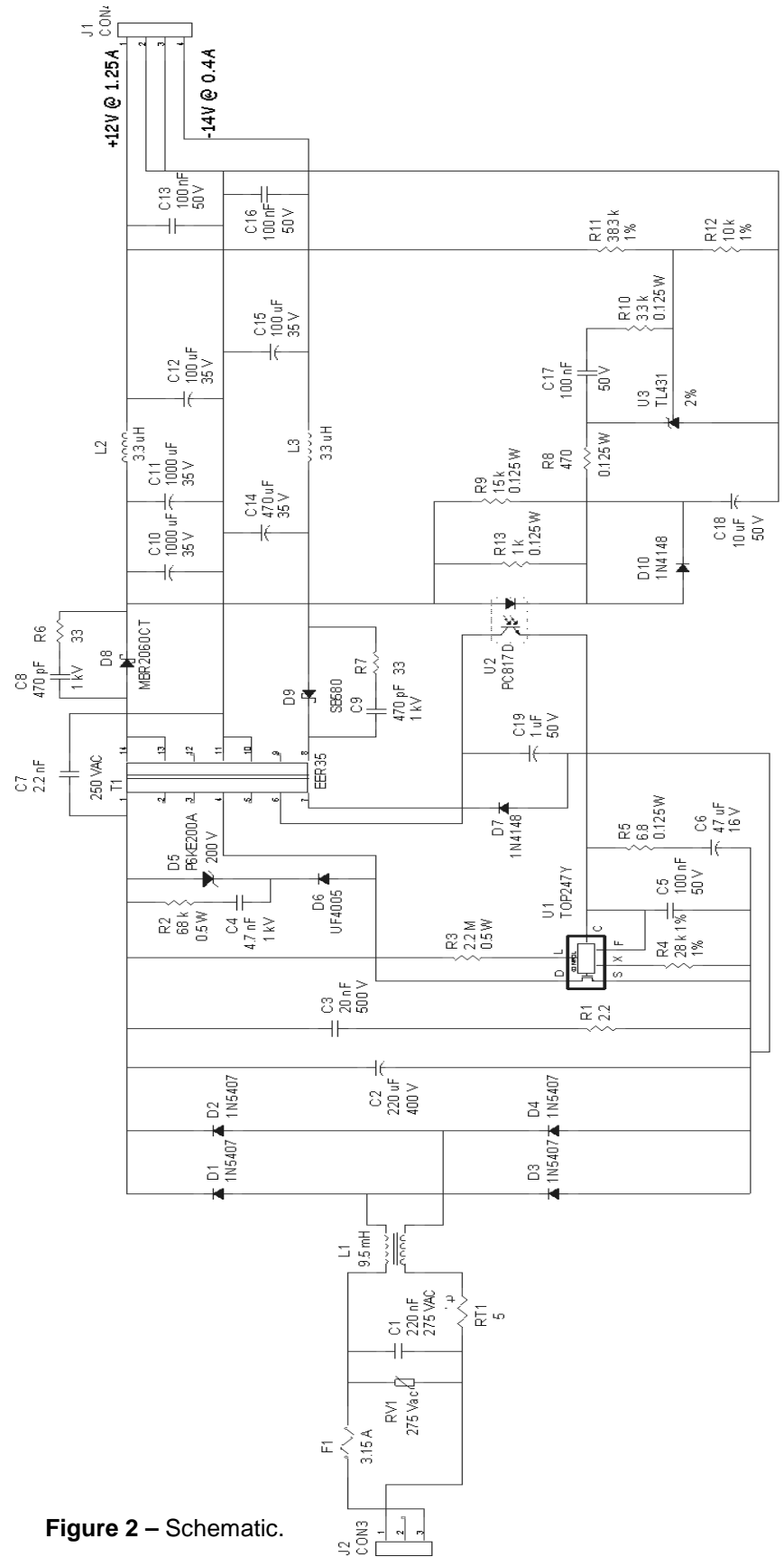

Figure 2 – Schematic.



4 Circuit Description

The schematic in Figure 2 shows an off-line Flyback converter using the TOP247Y. The circuit is designed for 85 VAC to 265 VAC input and provides two outputs; +12V @ 1.25A and -14V @ 0.4A.

4.1 Input EMI Filtering

Capacitor C1 and the leakage inductance of L1, filter differential-mode conducted EMI. Inductor L1 acts to reduce common-mode conducted EMI.

4.2 TOPSwitch Primary

The discrete full bridge rectifier bridge comprised of D1-D4 and C2 provide a high voltage DC BUS for the primary circuitry. C3 bypasses the high voltage DC rail. Resistor R1 provides damping that reduces mid-frequency conducted EMI. The DC rail is applied to the primary winding of T1. The other side of the transformer primary is driven by the integrated MOSFET in U1. Diode D6 and D5 clamp leakage spikes generated when the MOSFET in U1 switches off. Capacitor C4 reduces the operating temperature of D5 by bypassing the leading edge of the primary leakage spike away from D5. Resistor R2 provides damping to reduce drain ringing. Resistor R3 sets the low-line turn-on threshold to approximately 69 VAC, and also sets the over voltage shutdown level to approximately 320 VAC. R4 sets the U1 current limit to approximately 40% of its nominal value. This limits the output power delivered during fault conditions. C5 bypasses the U1 CONTROL pin. C6 has 3 functions. It provides the energy required by U1 during startup, sets the auto-restart frequency during fault conditions, and also acts to roll off the gain of U1 as a function of frequency. R5 adds a zero to stabilize the power supply control loop. Diode D7 and C19 provide rectified and filtered bias power for U2 and U1.

4.3 Output Rectification

The output of T1 is rectified and filtered by D8, C10-C11 and D9, C14. Inductor L2 (L3), C12 (C15), and C13 (C16) provide additional high frequency filtering. Resistor R6 (R7) and C8 (C9) provide snubbing for D8 (D9). Choosing the proper snubber values is important for low zero-load power consumption and for high frequency EMI suppression. The snubber components were chosen so that the turn-on voltage spike at the D8 (D9) anode is slightly under-damped. Increasing C8 and reducing R6 will improve damping and high frequency EMI, at the cost of higher zero-load power consumption.

4.4 Output Feedback

Resistors R11 and R12 divide down the supply output voltage and apply it to the reference pin of error amplifier U3. Shunt regulator U3 drives Optocoupler U2 through resistor R6 to provide feedback information to the U1 CONTROL pin. The Optocoupler output also provides power to U1 during normal operating conditions. Diode D10 and C18 apply drive to the Optocoupler during supply startup to eliminate output voltage overshoot. Diode D10 isolates C18 from the supply feedback loop after startup. Resistor R9 discharges C18 when the supply is off.



Components C6, C17, R5, R10 and R8 all play a role in compensating the power supply control loop. Capacitor C6 rolls off the gain of U1 at relatively low frequency. Resistor R5 provides a zero to cancel the phase shift of C6. Resistor R8 sets the gain of the direct signal path from the supply output through U2 and U3. Components C17 and R10 roll off the gain of U3



5 PCB Layout

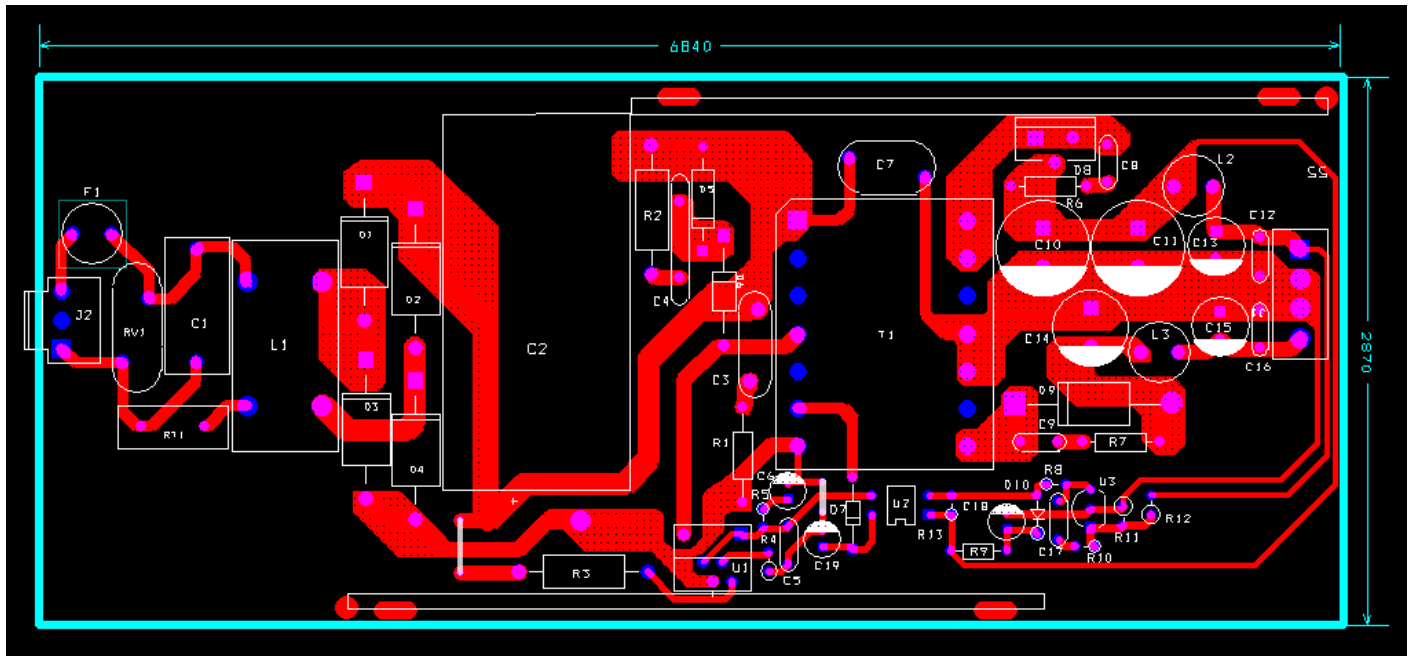

Figure 3 – Printed Circuit Layout.



6 Bill Of Materials

Item	QTY	Part Reference	Mfg Part Number	Description	Mfg	Value
1	1	C1	ECQ-U2A224ML	220nF, 275 VAC, Film, X2	Panasonic	220nF
2	1	C2	UVZ2G221MRD	220uF, 450V, Electrolytic, Gen. Purpose	Nichicon	220uF
3	1	C3	5GASS20	20nF, 500 V, Disc Ceramic	Vishay	20nF
4	1	C4	ECK-D3A472KBN	4.7nF, 1 kV, Disc Ceramic	Panasonic	4.7nF
5	4	C5 C13 C16 C17	ECU-S1H104KBB	100nF, 50 V, Ceramic, X7R 47uF, 16 V, Electrolytic, Gen. Purpose, (5 x 11)	Panasonic	100nF
6	1	C6	KME16VB47RM5X11LL	47uF, 16 V, Electrolytic, Gen. Purpose, (5 x 11)	United Chemi-Con	47uF
7	1	C7	440LD22	2.2nF, Ceramic, Y1	Vishay	2.2nF
8	2	C8 C9	NCD471K1KVY5F	470pF, 1 kV, Disc Ceramic	NIC Components Corp	470pF
9	2	C10 C11	LXZ35VB102MK25LL	1000uF, 35 V, Electrolytic, Low ESR, 30mOhm, (12.5 x 25)	United Chemi-Con	1000uF
10	2	C12 C15	KME35VB101M6X11LL	100uF, 35 V, Electrolytic, Gen. Purpose, (8 x 11.5)	United Chemi-Con	100uF
11	1	C14	KZE35VB471MJ20LL	470uF, 35 V, Electrolytic, Very Low ESR, 23mOhm, (10 x 20)	United Chemi-Con	470uF
12	1	C18	KME50VB10RM5X11LL	10uF, 50 V, Electrolytic, Gen. Purpose, (5 x 11)	United Chemi-Con	10uF
13	1	C19	KMG50VB1R0M5X11LL	1uF, 50 V, Electrolytic, Gen. Purpose, (5 x 11)	United Chemi-Con	1uF
14	4	D1 D2 D3 D4	1N5407	800 V, 3 A, Rectifier, DO-201AD	Vishay	1N5407
15	1	D5	P6KE200A	200 V, 5 W, 5%, DO204AC (DO-15)	Vishay	P6KE200A
16	1	D6	UF4005	600 V, 1 A, Ultrafast Recovery, 75 ns, DO-41	Vishay	UF4005
17	2	D7 D10	1N4148	75 V, 300mA, Fast Switching, DO-35	Vishay	1N4148
18	1	D8	MBR2060CT	60 V, 20 A, Dual Schottky, TO-220AB	Vishay	MBR2060CT
19	1	D9	SB580	80 V, 5 A, Schottky, DO-201AD	Vishay	SB580
20	1	F1	3,701,315,041	3.15 A, 250V, Fast, TR5	Wickman	3.15 A
21	1	J1	26-48-1045	CONN HEADER 4POS(1 X 4) .156 VERT TIN	Molex	CON4
22	1	J2	26-48-1031	CONN HEADER 3POS(1 X 3) .156 VERT TIN	Molex	CON3
23	1	L1	ELF18N012A	9.5mH, 1.2 A, Common Mode Choke	Panasonic	9.5mH
24	1	L2	ELC08D3R3E	3.3uH, 5.7 A	Panasonic	3.3uH
25	1	L3	822LY-3R3M	3.3uH, 2.66 A	Toko	3.3uH
26	1	R1	CFR-25JB-2R2	2.2 R, 5%, 1/4 W, Carbon Film	Yageo	2.2
27	1	R2	CFR-50JB-68K	68 k, 5%, 1/2 W, Carbon Film	Yageo	68 k
28	1	R3	CFR-50JB-2M2	2.2 M, 5%, 1/2 W, Carbon Film	Yageo	2.2 M
29	1	R4	MFR-25FBF-13K0	13 k, 1%, 1/4 W, Metal Film	Yageo	28 k 1%
30	1	R5	CFR-12JB-6R8	6.8 R, 5%, 1/8 W, Carbon Film	Yageo	6.8
31	2	R6 R7	CFR-25JB-33R	33 R, 5%, 1/4 W, Carbon Film	Yageo	33
32	1	R8	CFR-12JB-470R	470 R, 5%, 1/8 W, Carbon Film	Yageo	470
33	1	R9	CFR-12JB-15K	15 k, 5%, 1/8 W, Carbon Film	Yageo	15 k
34	1	R10	CFR-12JB-3K3	3.3 k, 5%, 1/8 W, Carbon Film	Yageo	3.3 k
35	1	R11	MFR-25FBF-38K3	38.3 k, 1%, 1/4 W, Metal Film	Yageo	38.3 k
36	1	R12	MFR-25FBF-10K0	10 k, 1%, 1/4 W, Metal Film	Yageo	10 k
37	1	R13	CFR-12JB-1K0	1 k, 5%, 1/8 W, Carbon Film	Yageo	1 k



38	1	RT1	CL150	NTC Thermistor, 5 Ohms, 4.7 A	Thermometrics	5 ohm
39	1	RV1	V275LA20A	275 V, 75 J, 14 mm, RADIAL	Littlefuse	275Vac
40	1	T1	YC-3508	Bobbin, EER35, Vertical, 14 pins	Ying Chin	EER35
41	1	U1	TOP247Y	TOPSwitch-GX, TOP247Y, TO220-7C	Power Integrations	TOP247Y
42	1	U2	ISP817D, PC817X4	Opto coupler, 35 V, CTR 300-600%, 4-DIP	Isocom, Sharp	PC817D
43	1	U3	TL431CLP	2.495 V Shunt Regulator IC, 2%, 0 to 70C, TO-92	Texas Instruments	TL431



7 Transformer Specification

7.1 Electrical Diagram

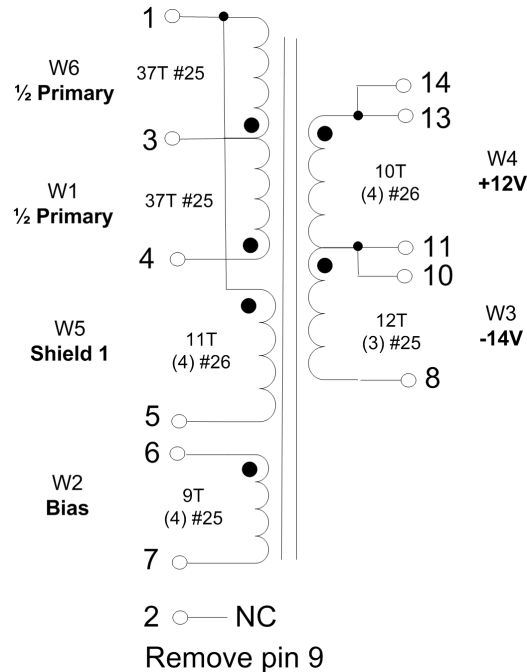

Figure 4 –Transformer Electrical Diagram

7.2 Electrical Specifications

Electrical Strength	1 second, 60 Hz, from Pins 1-7 to Pins 8-14	3000 VAC
Primary Inductance	Pins 1-4, all other windings open, measured at 66 kHz, 0.4 VRMS	683 μ H, +/-10%
Resonant Frequency	Pins 1-4, all other windings open	500 kHz (Min.)
Primary Leakage Inductance	Pins 1-4, with Pins 8-14 shorted, measured at 66 kHz, 0.4 VRMS	4 μ H (Max.)

7.3 Materials

Item	Description
[1]	Core: EER35 PC40 or equivalent, $Al=124nH/T^2$
[2]	Bobbin: Yin-Ching P/N: YC-3508 14-pin
[3]	Magnet Wire: #25 AWG Heavy Build
[4]	Magnet Wire: #26 AWG Heavy Build
[5]	Tape: 3M Tape
[6]	Varnish



7.4 Transformer Build Diagram

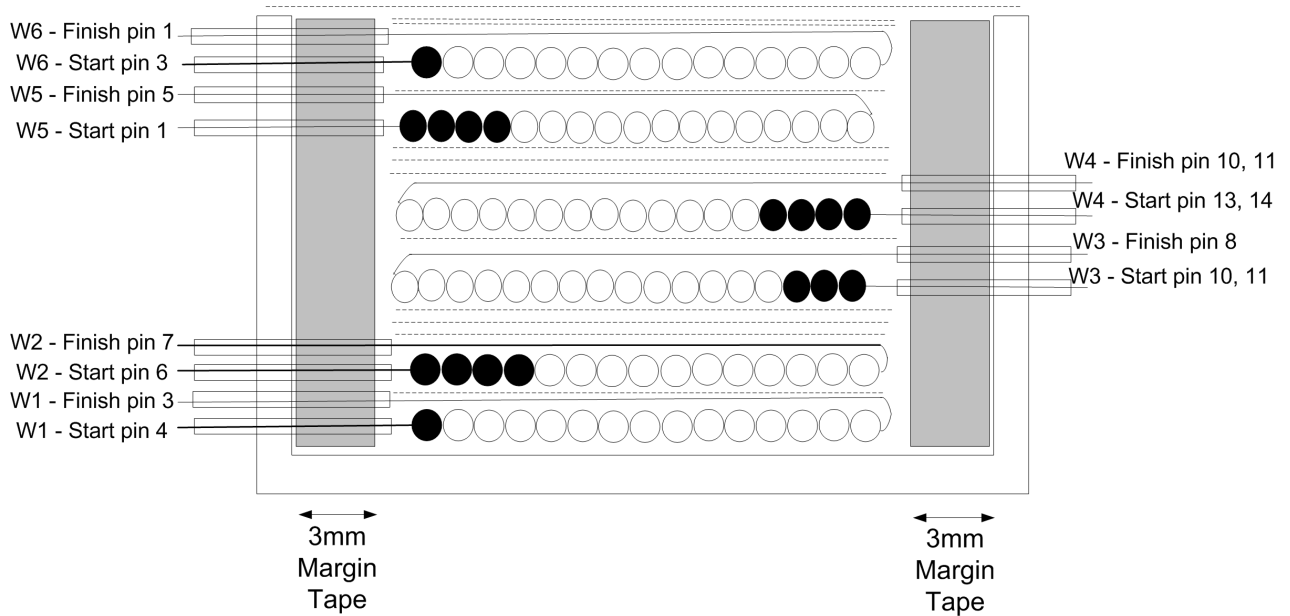

Figure 5 – Transformer Build Diagram.

7.5 Transformer Construction

Bobbin Preparation	Pull Pin 9 on bobbin [2] to provide polarization. Bobbin pin-out is shown below.
Margin Tape	Apply 3 mm wide margin to both sides of bobbin using item [5]. Match height of primary and bias windings.
½ Primary	Start at Pin 4. Wind 37 turns of #25 AWG in 1 layer, finish on Pin 3.
Basic Insulation	Use one layer of tape [5] for basic insulation.
Bias Winding	Starting at Pin 6, wind 9 quadfilars turns of #25 AWG. Spread turns evenly across bobbin width. Finish on Pin 7.
Basic Insulation	Use three layers of tape [5] for basic insulation.
Secondary Winding	Start at Pins 10 and 11. Wind 12 trifilar turns of #25 AWG uniformly on a single layer. Finish on Pin 8.
Basic Insulation	Use three layers of tape [5] for basic insulation.
Secondary Winding	Start at Pins 13 and 14. Wind 10 quadfilars turns of #25 AWG uniformly on a single layer. Finish on Pins 10 and 11.
Shield Winding	Start at Pin 1. Wind 11 quadfilars turns of #26 AWG in 1 layer, finish on Pin 5.
½ Primary	Start at Pin 3. Wind 37 turns of #25 AWG in 1 layer, finish on Pin 1.
Outer Wrap	Wrap windings with 3 layers of tape [5].
Final Assembly	Assemble and secure core halves so that the tape wrapped E core is at the bottom of the transformer. Dip varnish cores.



7.6 Bobbin Drawing

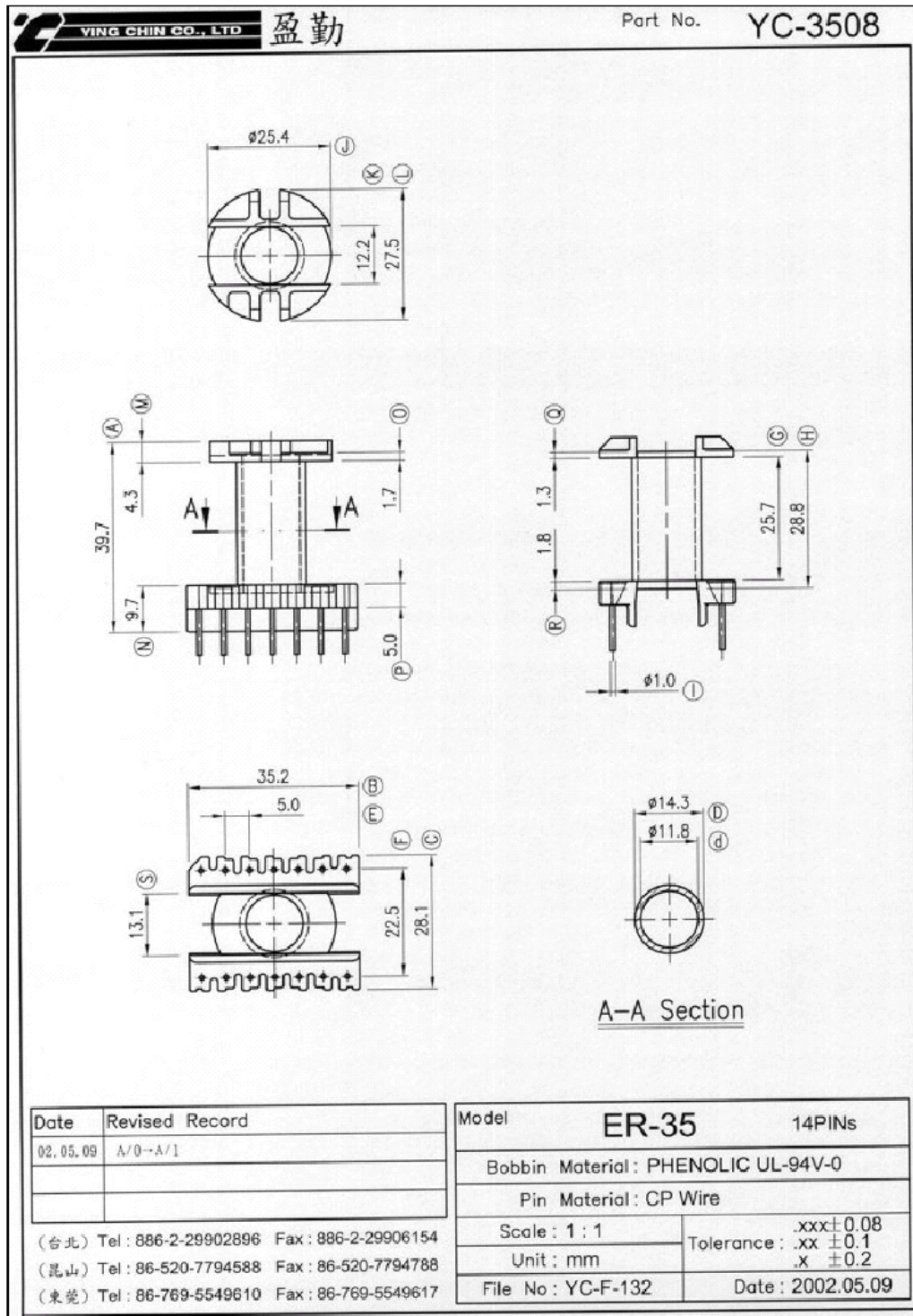

7.7 Transformer Spreadsheets

A	B	D	F	G	I
ACDC_TOPSwitchGX_032204; Rev.1.9; Copyright Power Integrations Inc. 2004	INPUT	INFO	OUTPUT	UNIT	TOP_GX_FX_032204.xls: TOPSwitch-GX/FX Continuous/Discontinuous Flyback Transformer Design Spreadsheet
ENTER APPLICATION VARIABLES					oktop 105C TOP248Y EER35 66kHz
VACMIN	85			Volts	Minimum AC Input Voltage
VACMAX	265			Volts	Maximum AC Input Voltage
FL	50			Hertz	AC Mains Frequency
VO	12			Volts	Output Voltage
PO	20.768			Watts	Output Power
n	0.73				Efficiency Estimate
Z	0.5				Loss Allocation Factor
VB	12			Volts	Bias Voltage
tC	3			mSeconds	Bridge Rectifier Conduction Time Estimate
CIN	220			uFarads	Input Filter Capacitor
ENTER TOPSWITCH-GX VARIABLES					
TOP-GX	top247			Universal	115 Doubled/230V
Chosen Device		TOP247	Power Out	125W	165W
KI	0.4				External Ilimit reduction factor (KI=1.0 for default ILIMIT, KI <1.0 for lower ILIMIT)
ILIMITMIN			1.296	Amps	Use 1% resistor in setting external ILIMIT
ILIMITMAX			1.584	Amps	Use 1% resistor in setting external ILIMIT
Frequency - (F)=132kHz, (H)=66kHz		h			Half (H) frequency option - 66kHz
fS			66000	Hertz	TOPSwitch-GX Switching Frequency. Choose between 132 kHz and 66 kHz
fSmin			61500	Hertz	TOPSwitch-GX Minimum Switching Frequency
fSmax			70500	Hertz	TOPSwitch-GX Maximum Switching Frequency
VOR	93.5			Volts	Reflected Output Voltage
VDS	10			Volts	TOPSwitch on-state Drain to Source Voltage
VD	0.6			Volts	Output Winding Diode Forward Voltage Drop
VDB	0.7			Volts	Bias Winding Diode Forward Voltage Drop
KP	1.038				Ripple to Peak Current Ratio (0.4 < KRP < 1.0 ; 1.0 < KDP < 6.0)
ENTER TRANSFORMER CORE/CONSTRUCTION VARIABLES					
Core Type	eer35				
Core		EER35		P/N:	PC40EER35-Z
Bobbin		EER35_BOBBIN		P/N:	BEER-35-1116CPH
AE			1.07	cm^2	Core Effective Cross Sectional Area
LE			9.08	cm	Core Effective Path Length
AL			2770	nH/T^2	Ungapped Core Effective Inductance
BW			26.1	mm	Bobbin Physical Winding Width
M	3			mm	Safety Margin Width (Half the Primary to Secondary Creepage Distance)
L	1.4				Number of Primary Layers
NS	10				Number of Secondary Turns
DC INPUT VOLTAGE PARAMETERS					
VMIN			112	Volts	Minimum DC Input Voltage
VMAX			375	Volts	Maximum DC Input Voltage
CURRENT WAVEFORM SHAPE PARAMETERS					
DMAX			0.47		Maximum Duty Cycle
Iavg			0.25	Amps	Average Primary Current
IP			1.08	Amps	Peak Primary Current
IR			1.08	Amps	Primary Ripple Current
IRMS			0.43	Amps	Primary RMS Current
TRANSFORMER PRIMARY DESIGN PARAMETERS					
LP			684	uHenries	Primary Inductance
NP			74		Primary Winding Number of Turns
NB			10		Bias Winding Number of Turns
ALG			124	nH/T^2	Gapped Core Effective Inductance
BM			932	Gauss	Maximum Flux Density at PO, VMIN (BM<3000)
BP			1365	Gauss	Peak Flux Density (BP<4200)
BAC			466	Gauss	AC Flux Density for Core Loss Curves (0.5 X Peak to Peak)
ur			1871		Relative Permeability of Ungapped Core
LG			1.03	mm	Gap Length (Lg > 0.1 mm)
BWE			28.14	mm	Effective Bobbin Width
OD			0.38	mm	Maximum Primary Wire Diameter including insulation
INS			0.06	mm	Estimated Total Insulation Thickness (= 2 * film thickness)
DIA			0.32	mm	Bare conductor diameter
AWG			29	AWG	Primary Wire Gauge (Rounded to next smaller standard AWG value)
CM			128	Cmils	Bare conductor effective area in circular mils
CMA			300	Cmils/Amp	Primary Winding Current Capacity (200 < CMA < 500)
TRANSFORMER SECONDARY DESIGN PARAMETERS (SINGLE OUTPUT / SINGLE OUTPUT EQUIVALENT)					
Lumped parameters					
ISP			8.03	Amps	Peak Secondary Current



A	B	D	F	G	I
ISRMS			3.32	Amps	Secondary RMS Current
IO			1.73	Amps	Power Supply Output Current
IRIPPLE			2.83	Amps	Output Capacitor RMS Ripple Current
CMS			664	Cmils	Secondary Bare Conductor minimum circular mils
AWGS			21	AWG	Secondary Wire Gauge (Rounded up to next larger standard AWG value)
DIAS			0.73	mm	Secondary Minimum Bare Conductor Diameter
QDS			2.01	mm	Secondary Maximum Outside Diameter for Triple Insulated Wire
INSS			0.64	mm	Maximum Secondary Insulation Wall Thickness
VOLTAGE STRESS PARAMETERS					
VDRAIN			591	Volts	Maximum Drain Voltage Estimate (Includes Effect of Leakage Inductance)
PIVS			63	Volts	Output Rectifier Maximum Peak Inverse Voltage
PIVB			63	Volts	Bias Rectifier Maximum Peak Inverse Voltage
TRANSFORMER SECONDARY DESIGN PARAMETERS (MULTIPLE OUTPUTS)					
1st output					
VO1	12.0			Volts	Output Voltage
IO1	1.250			Amps	Output DC Current
PO1			15.00	Watts	Output Power
VD1	0.6			Volts	Output Diode Forward Voltage Drop
NS1			10.00		Output Winding Number of Turns
ISRMS1			2.396	Amps	Output Winding RMS Current
IRIPPLE1			2.04	Amps	Output Capacitor RMS Ripple Current
PIVS1			63	Volts	Output Rectifier Maximum Peak Inverse Voltage
CMS1			479	Cmils	Output Winding Bare Conductor minimum circular mils
AWGS1			23	AWG	Wire Gauge (Rounded up to next larger standard AWG value)
DIAS1			0.58	mm	Minimum Bare Conductor Diameter
QDS1			2.01	mm	Maximum Outside Diameter for Triple Insulated Wire
2nd output					
VO2	14.4			Volts	Output Voltage
IO2	0.400			Amps	Output DC Current
PO2			5.77	Watts	Output Power
VD2	0.7			Volts	Output Diode Forward Voltage Drop
NS2			12.00		Output Winding Number of Turns
ISRMS2			0.767	Amps	Output Winding RMS Current
IRIPPLE2			0.65	Amps	Output Capacitor RMS Ripple Current
PIVS2			75	Volts	Output Rectifier Maximum Peak Inverse Voltage
CMS2			153	Cmils	Output Winding Bare Conductor minimum circular mils
AWGS2			28	AWG	Wire Gauge (Rounded up to next larger standard AWG value)
DIAS2			0.32	mm	Minimum Bare Conductor Diameter
QDS2			1.68	mm	Maximum Outside Diameter for Triple Insulated Wire
3rd output					
VO3	0.0			Volts	Output Voltage
IO3	0.000			Amps	Output DC Current
PO3			0.00	Watts	Output Power
VD3	0.0			Volts	Output Diode Forward Voltage Drop
NS3			0.00		Output Winding Number of Turns
ISRMS3			0.000	Amps	Output Winding RMS Current
IRIPPLE3			0.00	Amps	Output Capacitor RMS Ripple Current
PIVS3			0	Volts	Output Rectifier Maximum Peak Inverse Voltage
CMS3			0	Cmils	Output Winding Bare Conductor minimum circular mils
AWGS3			#NUM!	AWG	Wire Gauge (Rounded up to next larger standard AWG value)
DIAS3			#NUM!	mm	Minimum Bare Conductor Diameter
QDS3			#DIV/0!	mm	Maximum Outside Diameter for Triple Insulated Wire
Total power			20.768	Watts	Total Power for Multi-output section



8 Performance Data

All measurements performed at room temperature, 60 Hz input frequency.

8.1 Efficiency

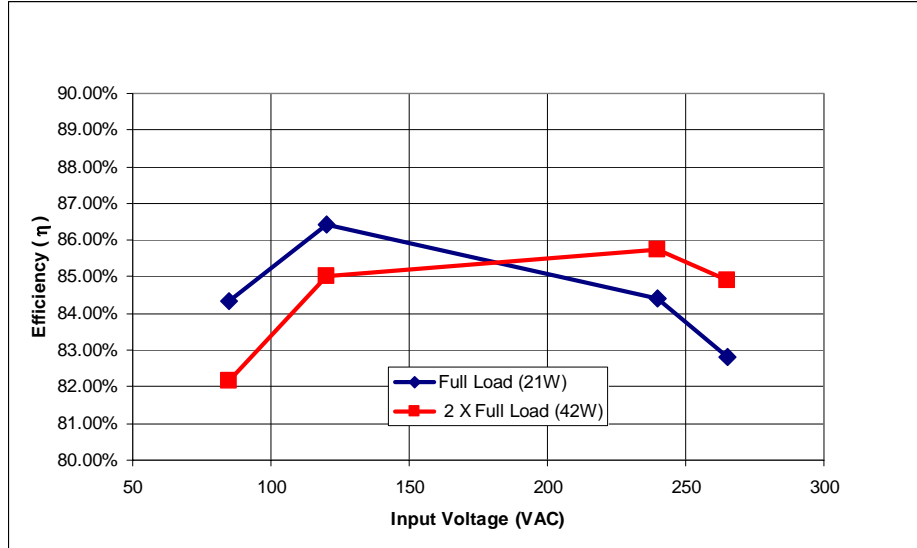

Figure 6 - Efficiency vs. Input Voltage, Room Temperature, 60 Hz.

8.2 Minimum Load Input Power

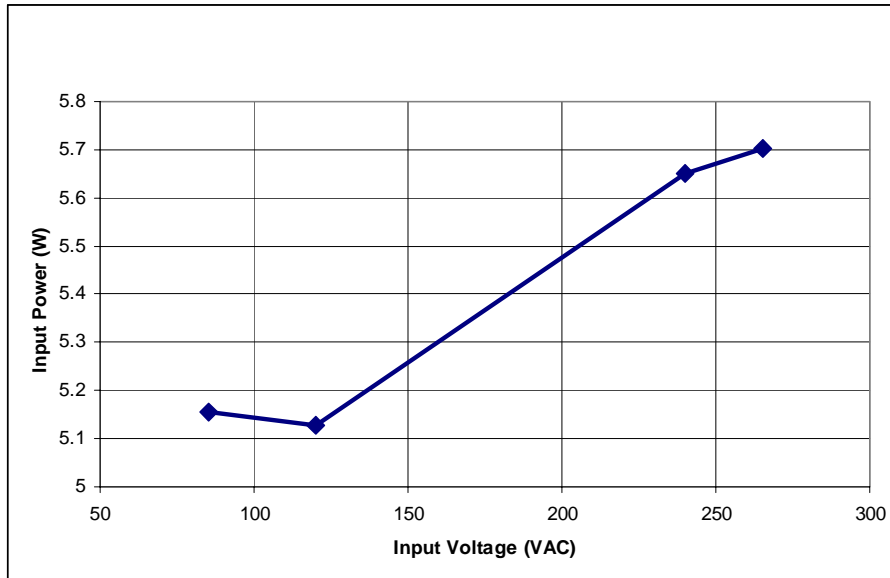

Figure 7 - Input Power vs. Input Line Voltage, Room Temperature, 60 Hz.



8.3 Regulation

8.3.1 Load

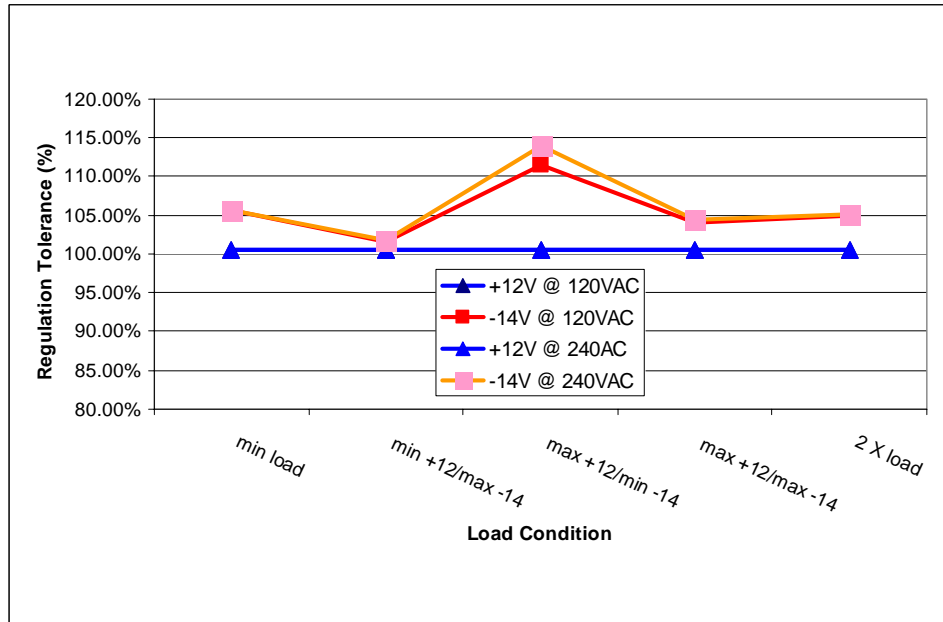

Figure 8 – Load Regulation, Room Temperature.

8.3.2 Line

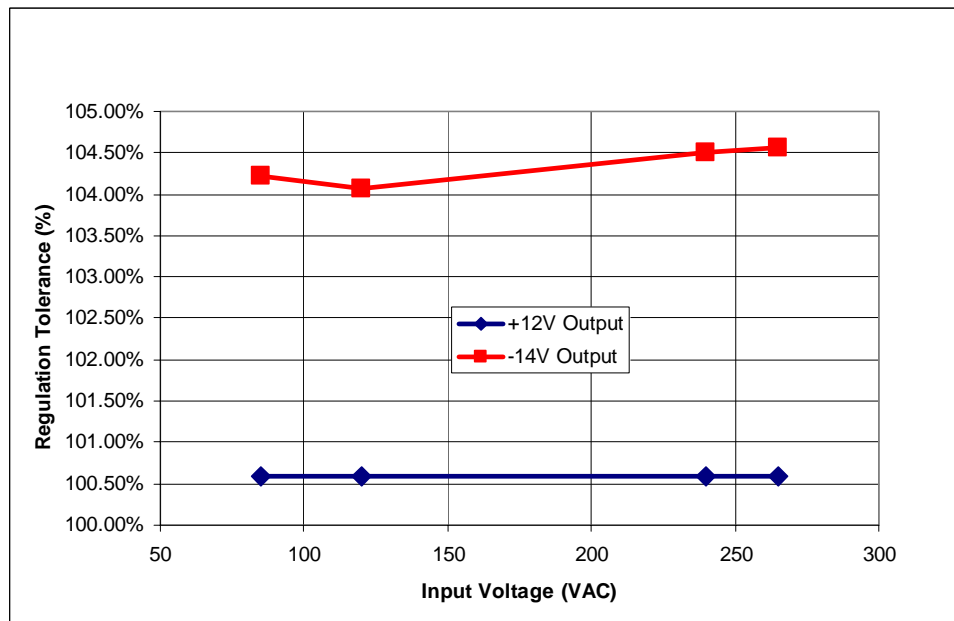

Figure 9 – Line Regulation, Room Temperature, Full Load.



9 Thermal Performance

Unit was placed into a box in a thermal chamber at 105°C and allowed to reach thermal equilibrium. The unit was placed in a box to prevent any airflow from the thermal chamber fan from reaching the unit. Thermocouples were placed on the TOPSwitch, output rectifier and transformer. At full rated load the unit does not have any appreciable temperature rise over the ambient.

Temperature (°C)		
Item	115VAC	230VAC
Ambient	105	105
Transformer (T1)	109	105
TOPSwitch (U1)	105	105
Rectifier (D8)	105	105
Capacitor (C10)	105	105



10 Waveforms

10.1 Drain Voltage and Current, Normal Operation



Figure 10 - 85 VAC, Full Load.
Upper: I_{DRAIN} , 0.5 A / div
Lower: V_{DRAIN} , 100 V, 5 μ s / div



Figure 11 - 265 VAC, Full Load
Upper: I_{DRAIN} , 0.5 A / div
Lower: V_{DRAIN} , 200 V / div, 5 μ s / div

10.2 Output Voltage Start-up Profile

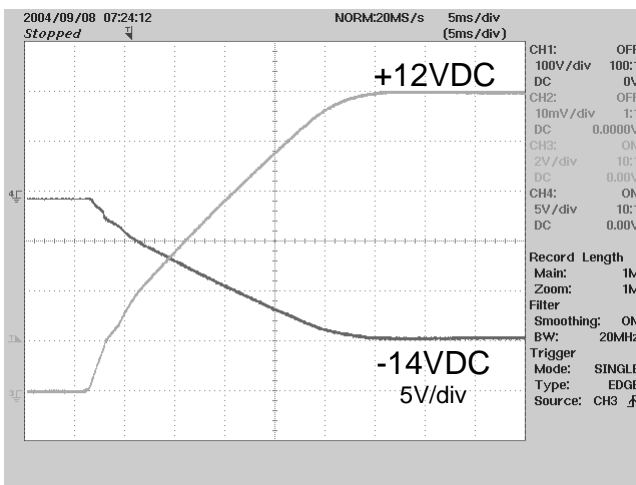

Figure 12 - Start-up Profile, 85VAC
2 V, 5 ms / div.

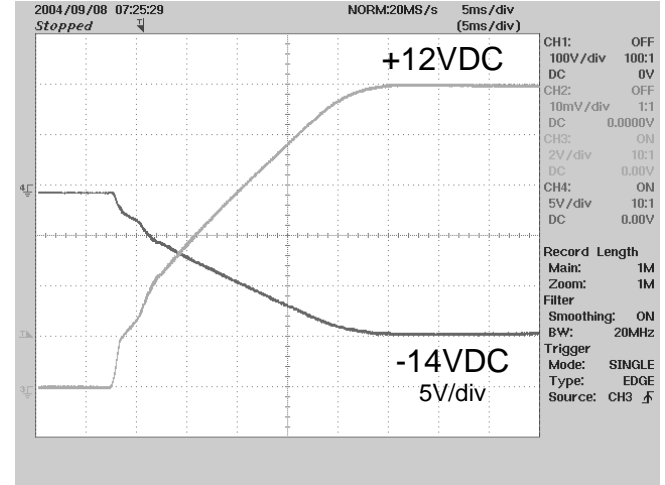

Figure 13 - Start-up Profile, 265 VAC
2 V, 5 ms / div.



10.3 Drain Voltage and Current Start-up Profile

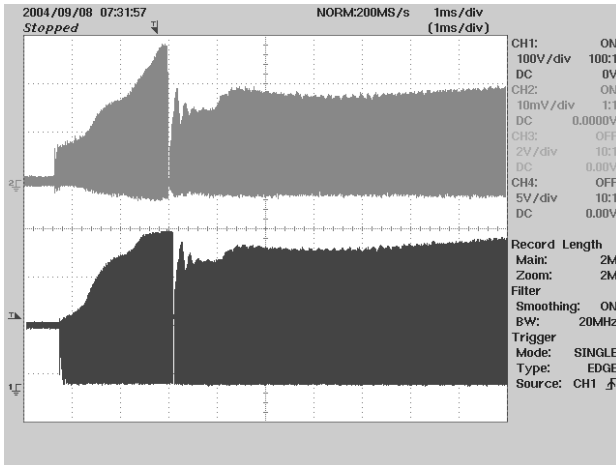

Figure 14 - 85 VAC Input and Maximum Load.
Upper: I_{DRAIN} , 0.5 A / div.
Lower: V_{DRAIN} , 100 V & 1 ms / div.

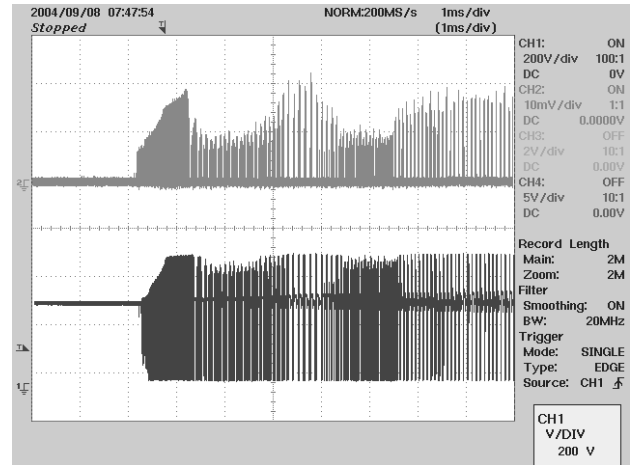

Figure 15 - 265 VAC Input and Maximum Load.
Upper: I_{DRAIN} , 1 A / div.
Lower: V_{DRAIN} , 200 V & 1 ms / div.

10.4 Load Transient Response (75% to 100% Load Step)

In the figures shown below, signal averaging was used to better enable viewing the load transient response. The oscilloscope was triggered using the load current step as a trigger source. Since the output switching and line frequency occur essentially at random with respect to the load transient, contributions to the output ripple from these sources will average out, leaving the contribution only from the load step response.

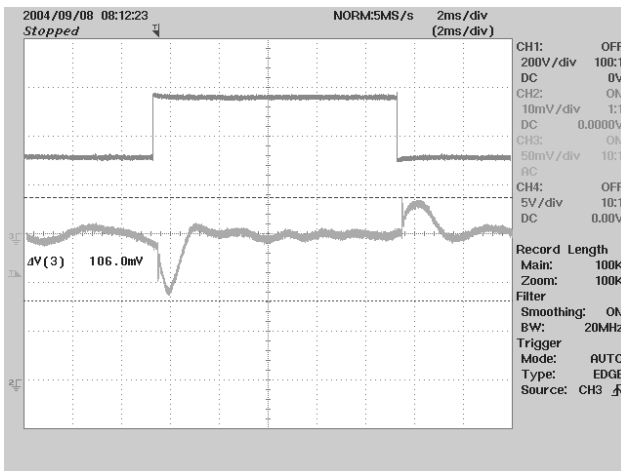

Figure 16 – Transient Response, 115 VAC, 75-100-75% Load Step.
Top: Load Current, 200mA/div.
Bottom: Output Voltage
50 mV, 500 μ s / div.

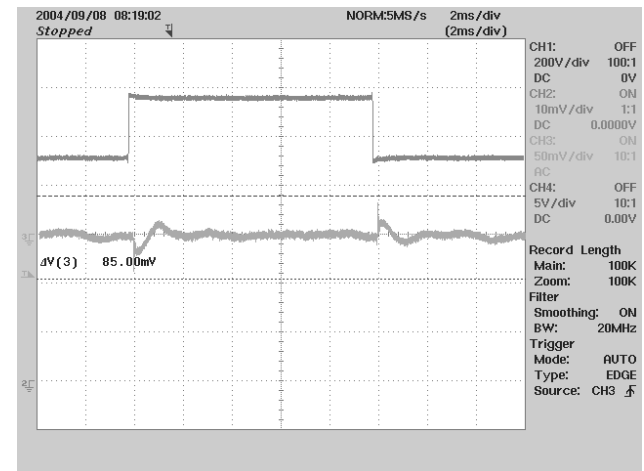

Figure 17 – Transient Response, 230 VAC, 75-100-75% Load Step
Upper: Load Current, 200mA / div.
Bottom: Output Voltage
50 mV, 2 ms / div.



10.5 Output Ripple Measurements

10.5.1 Ripple Measurement Technique

For DC output ripple measurements, a modified oscilloscope test probe must be utilized in order to reduce spurious signals due to pickup. Details of the probe modification are provided in Figure 18 and Figure 19.

The 5125BA probe adapter is affixed with two capacitors tied in parallel across the probe tip. The capacitors include one (1) 0.1 $\mu\text{F}/50\text{ V}$ ceramic type and one (1) 1.0 $\mu\text{F}/50\text{ V}$ aluminum electrolytic. **The aluminum electrolytic type capacitor is polarized, so proper polarity across DC outputs must be maintained (see below).**

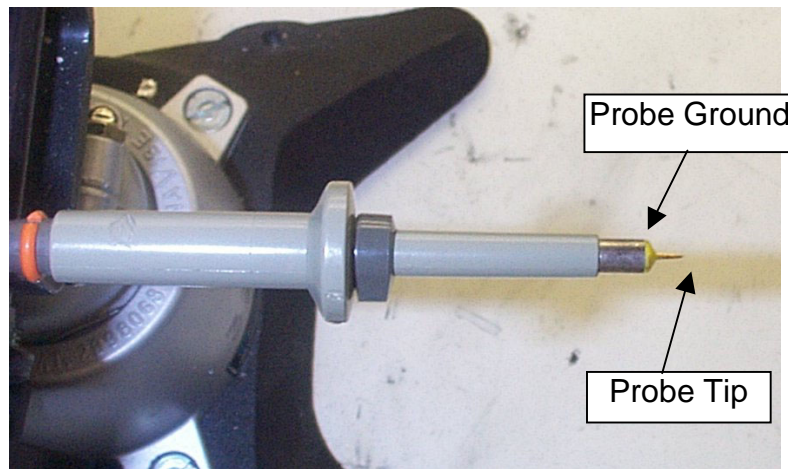

Figure 18 - Oscilloscope Probe Prepared for Ripple Measurement. (End Cap and Ground Lead Removed)

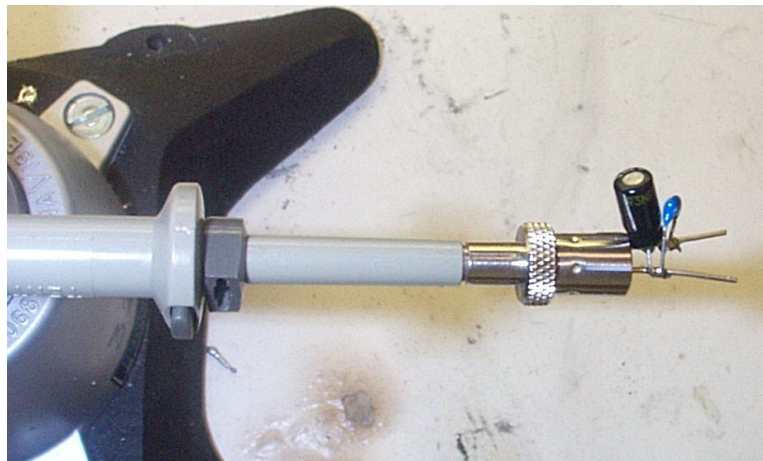

Figure 19 - Oscilloscope Probe with Probe Master 5125BA BNC Adapter. (Modified with wires for probe ground for ripple measurement, and two parallel decoupling capacitors added)

10.5.2 Measurement Results

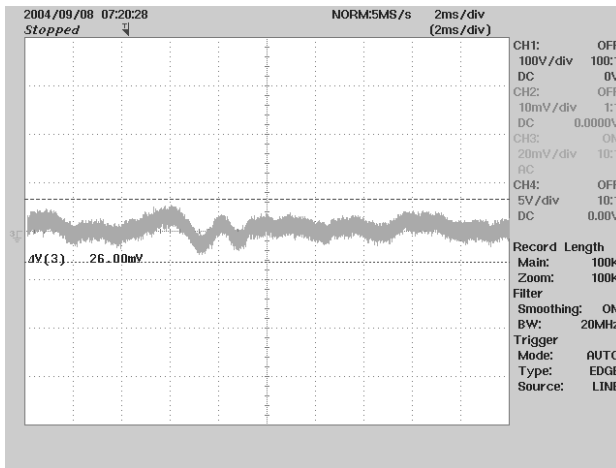

Figure 20 – 12V Ripple, 85 VAC, Full Load.
2 ms, 20 mV / div

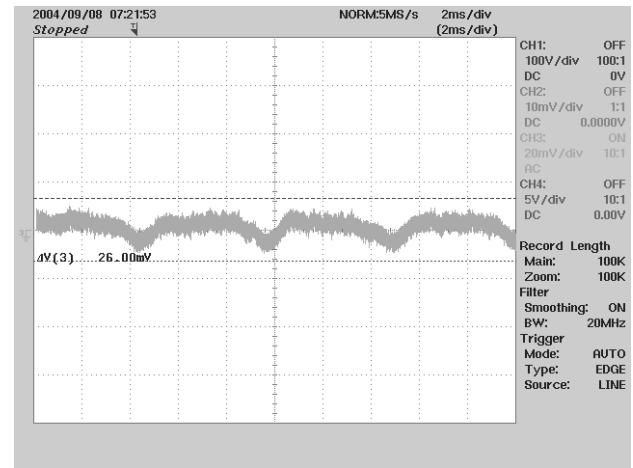

Figure 21 - 12V Ripple, 265 VAC, Full Load.
2 ms, 20 mV / div



11 Control Loop Measurements

11.1 85 VAC Input

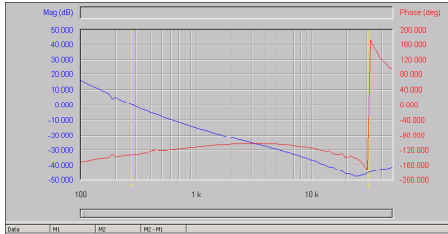

Figure 22 - Gain-Phase Plot, 1/2 Load (10W)
 Scale:
 Gain = 10 dB/div, Phase = 40 °/div.
 Crossover Frequency = 274Hz
 Phase Margin = 46.9°

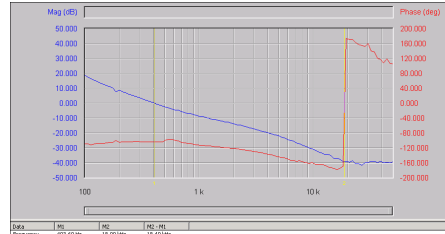

Figure 23 - Gain-Phase Plot, Full Load (20W)
 Scale:
 Gain = 10 dB/div, Phase = 40 °/div.
 Crossover Frequency = 403.7Hz
 Phase Margin = 75.9°

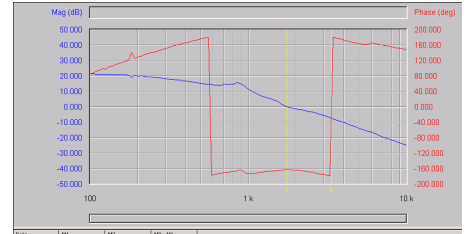

Figure 24 - Gain-Phase Plot, 2X Load (40W)
 Scale:
 Gain = 10 dB/div, Phase = 40 °/div.
 Crossover Frequency = 1.75 kHz
 Phase Margin = 16.9°

11.2 265 VAC Input

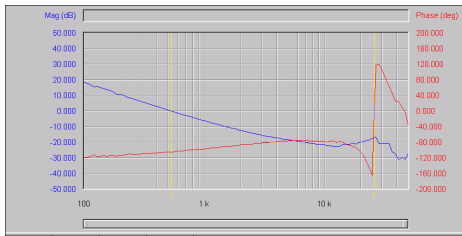

Figure 25 - Gain-Phase Plot, 1/2 Load (10W)
 Scale:
 Gain = 10 dB/div, Phase = 40 °/div.
 Crossover Frequency = 528.3Hz
 Phase Margin = 75.1°

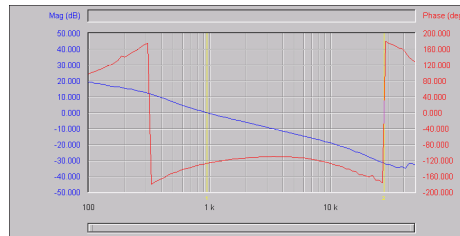

Figure 26 - Gain-Phase Plot, Full Load (20W)
 Scale:
 Gain = 10 dB/div, Phase = 40 °/div.
 Crossover Frequency = 950.4Hz
 Phase Margin = 52.8°

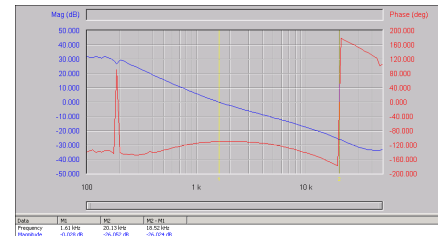

Figure 27 - Gain-Phase Plot, 2X Load (40W)
 Scale:
 Gain = 10 dB/div, Phase = 40 °/div.
 Crossover Frequency = 1.61 kHz
 Phase Margin = 69.6°

The power supply has very good stability criteria over the intended operating input voltage and output power range.



12 Conducted EMI

A conducted EMI scan of the prototype was taken to determine the effectiveness of the input filter, transformer construction and layout. The following plots show the Peak performance of the converter against quasi-peak (QP) and average (AVG) limits of EN55022 Class B. Both scans were taken at 115VAC/60Hz input with peak load applied to both output rails.

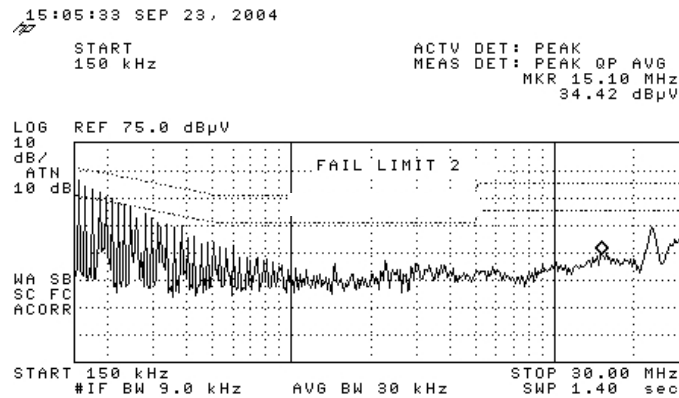

Figure 28 - Conducted EMI, Maximum Steady State Load (Line)

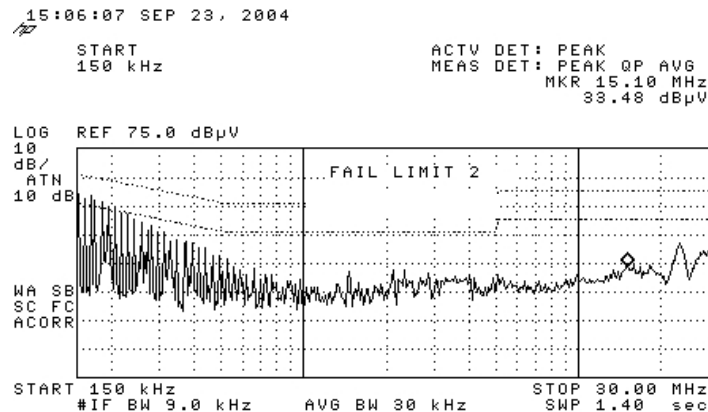

Figure 29 - Conducted EMI, Maximum Steady State Load (Neutral)

Since the peak scan is below the average limits, it is expected that the QP scans would have greater than 10db of margin below the limits.



13 Revision History

Date	Author	Revision	Description & changes	Reviewed
April 20, 2005	EC/RSP	1.0	Initial release	VC / AM



For the latest updates, visit our Web site: www.powerint.com

Power Integrations may make changes to its products at any time. Power Integrations has no liability arising from your use of any information, device or circuit described herein nor does it convey any license under its patent rights or the rights of others. POWER INTEGRATIONS MAKES NO WARRANTIES HEREIN AND SPECIFICALLY DISCLAIMS ALL WARRANTIES INCLUDING, WITHOUT LIMITATION, THE IMPLIED WARRANTIES OF MERCHANTABILITY, FITNESS FOR A PARTICULAR PURPOSE, AND NON-INFRINGEMENT OF THIRD PARTY RIGHTS.

PATENT INFORMATION

The products and applications illustrated herein (including circuits external to the products and transformer construction) may be covered by one or more U.S. and foreign patents or potentially by pending U.S. and foreign patent applications assigned to Power Integrations. A complete list of Power Integrations' patents may be found at www.powerint.com.

The PI Logo, **TOPSwitch**, **TinySwitch**, **LinkSwitch**, and **EcoSmart** are registered trademarks of Power Integrations. **PI Expert** and **DPA-Switch** are trademarks of Power Integrations.

© Copyright 2004, Power Integrations.

Power Integrations Worldwide Sales Support Locations

WORLD HEADQUARTERS

5245 Hellyer Avenue,
San Jose, CA 95138, USA
Main: +1-408-414-9200
Customer Service:
Phone: +1-408-414-9665
Fax: +1-408-414-9765
e-mail:
usasales@powerint.com

CHINA (SHANGHAI)

Rm 807, Pacheer,
Commercial Centre,
555 Nanjing West Road,
Shanghai, 200041, China
Phone: +86-21-6215-5548
Fax: +86-21-6215-2468
e-mail:
chinasales@powerint.com

CHINA (SHENZHEN)

Rm# 1705, Bao Hua Bldg.
1016 Hua Qiang Bei Lu,
Shenzhen, Guangdong,
518031, China
Phone: +86-755-8367-5143
Fax: +86-755-8377-9610
e-mail:
chinasales@powerint.com

APPLICATIONS HOTLINE

World Wide +1-408-414-9660

GERMANY

Rueckertstrasse 3,
D-80336, Munich, Germany
Phone: +49-895-527-3910
Fax: +49-895-527-3920
e-mail: eurosales@powerint.com

INDIA (TECHNICAL SUPPORT)

Innovatech
261/A, Ground Floor
7th Main, 17th Cross,
Sadashivanagar
Bangalore, India, 560080
Phone: +91-80-5113-8020
Fax: +91-80-5113-8023
e-mail: indiasales@powerint.com

ITALY

Via Vittorio Veneto 12, Bresso,
Milano,
20091, Italy
Phone: +39-028-928-6001
Fax: +39-028-928-6009
e-mail: eurosales@powerint.com

APPLICATIONS FAX

World Wide +1-408-414-9760

JAPAN

Keihin-Tatemono 1st Bldg.
12-20 Shin-Yokohama,
2-Chome,
Kohoku-ku, Yokohama-shi,
Kanagawa 222-0033, Japan
Phone: +81-45-471-1021
Fax: +81-45-471-3717
e-mail:
japansales@powerint.com

KOREA

8th Floor, DongSung Bldg.
17-8 Yoido-dong,
Youngdeungpo-gu,
Seoul, 150-874, Korea
Phone: +82-2-782-2840
Fax: +82-2-782-4427
e-mail:
koreasales@powerint.com

SINGAPORE

51 Newton Road,
#15-08/10 Goldhill Plaza,
Singapore, 308900
Phone: +65-6358-2160
Fax: +65-6358-2015
e-mail:
singaporesales@powerint.com

TAIWAN

17F-3, No. 510,
Chung Hsiao E. Rd., Sec. 5,
Taipei, Taiwan 110, R.O.C.
Phone: +886-2-2727-1221
Fax: +886-2-2727-1223
e-mail:
taiwansales@powerint.com

UK (EUROPE & AFRICA HEADQUARTERS)

1st Floor, St. James's House
East Street
Farnham, Surrey GU9 7TJ
United Kingdom
Phone: +44-1252-730-140
Fax: +44-1252-727-689
e-mail: eurosales@powerint.com

ER or EPR template – Rev 3.6 – Single sided

