

SHINDENGEN

Schottky Rectifiers (SBD)

Single

DE10P3

30V 10A

FEATURES

- SMT
- Super low $V_F=0.4V$
- High current capacity with Small Package

APPLICATION

- Reversed Battery Connection Protection
- DC OR output
- DC/DC converter
- Mobile telephone, personal computer

OUTLINE DIMENSIONS

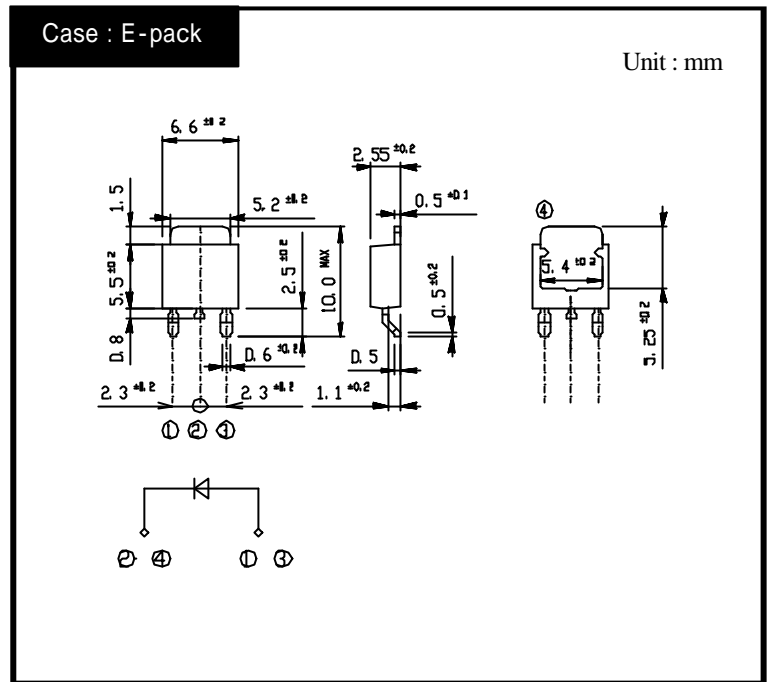

RATINGS

Absolute Maximum Ratings (If not specified $T_C=25$)

Item	Symbol	Conditions	Ratings	Unit
Storage Temperature	T_{stg}		-55 ~ 125	
Operating Junction Temperature	T_j		125	
Maximum Reverse Voltage	V_{RM}		30	V
Repetitive Peak Surge Reverse Voltage	V_{RRSM}	Pulse width 0.5ms, duty 1/40	35	V
Average Rectified Forward Current	I_O	50Hz sine wave, R-load $T_C=95$	10	A
Peak Surge Forward Current	I_{FSM}	50Hz sine wave, Non-repetitive 1 cycle peak value, $T_j=25$	200	A

Electrical Characteristics (If not specified $T_C=25$)

Item	Symbol	Conditions	Ratings	Unit
Forward Voltage	V_F	$I_F=8A$, Pulse measurement	Max.0.40	V
Reverse Current	I_R	$V_R=V_{RM}$, Pulse measurement	Max.25	mA
Junction Capacitance	C_j	$f=1MHz$, $V_R=10V$	Typ.600	pF
Thermal Resistance	θ_{jc}	junction to case	Max.4.0	/W

DE10P3

Forward Voltage

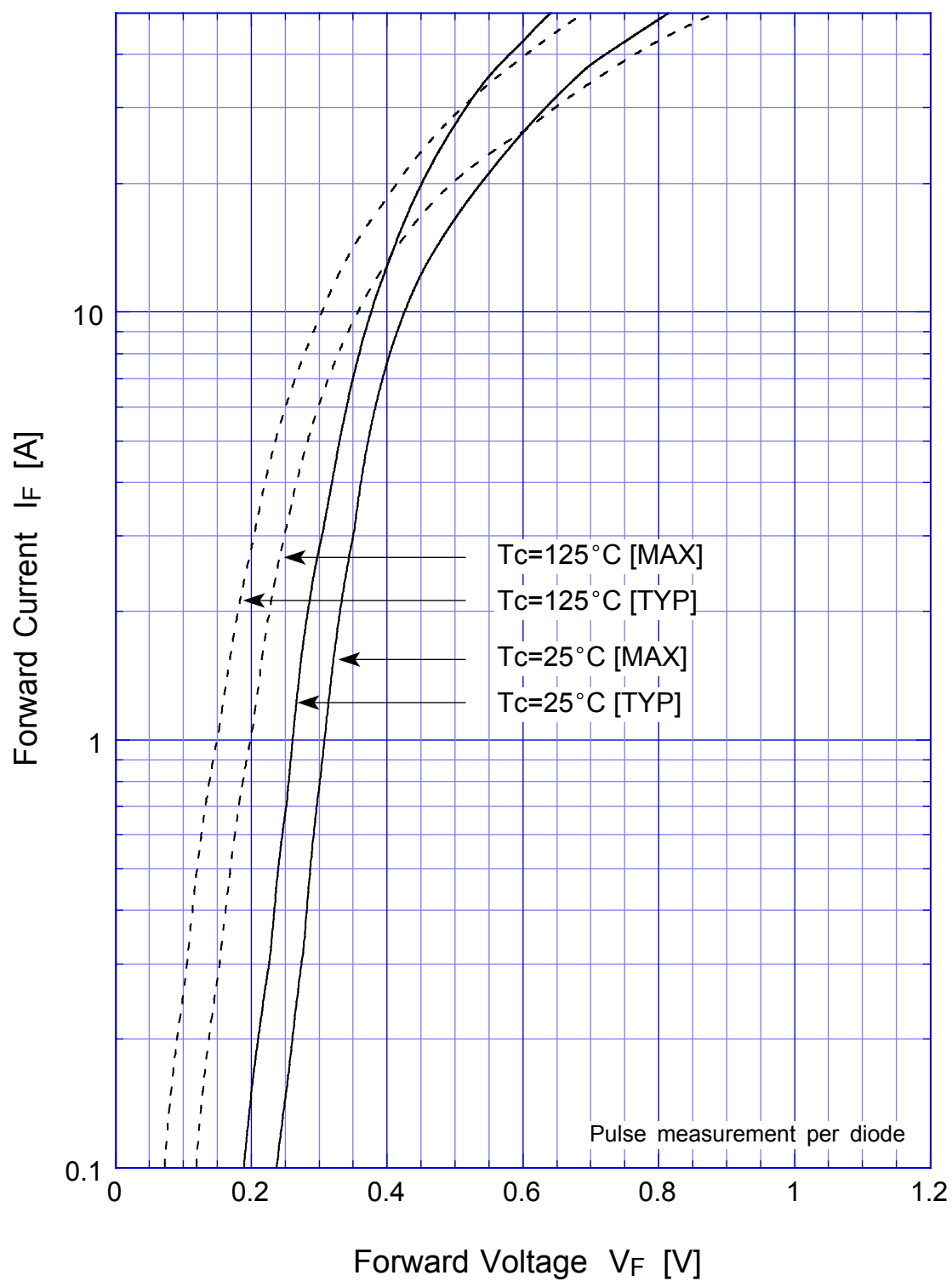

DE10P3

Junction Capacitance

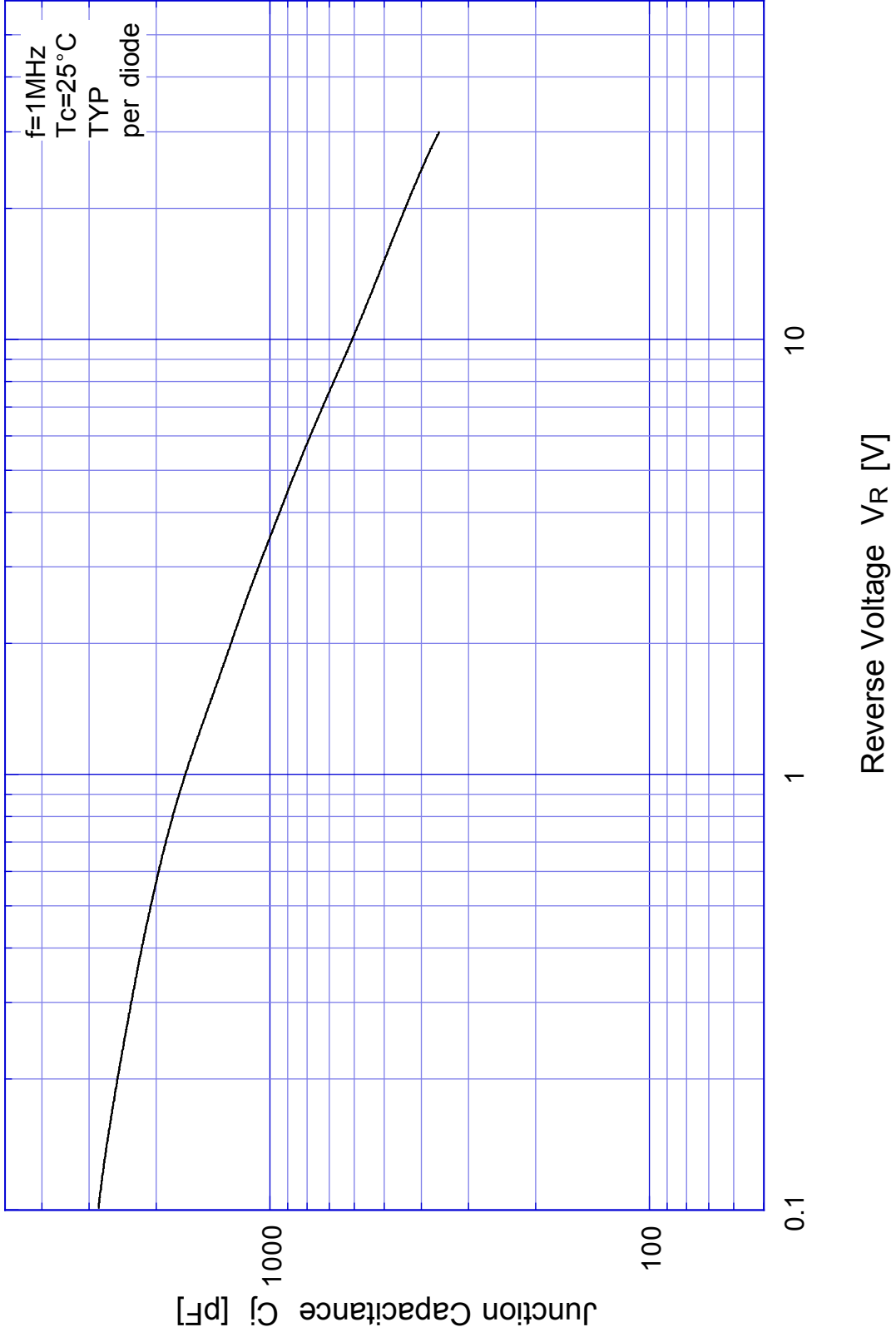

DE10P3

Reverse Current

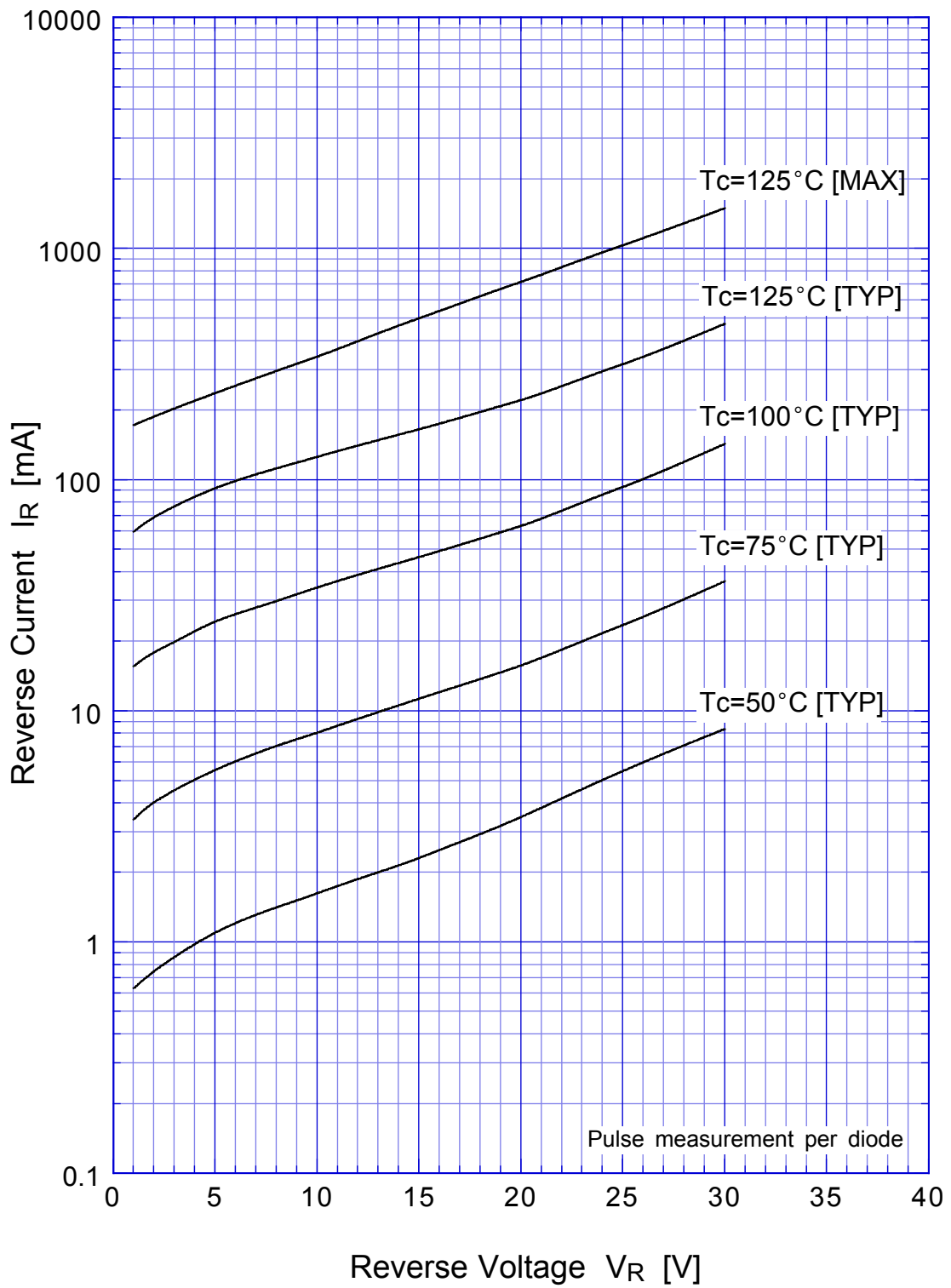

DE10P3 Reverse Power Dissipation

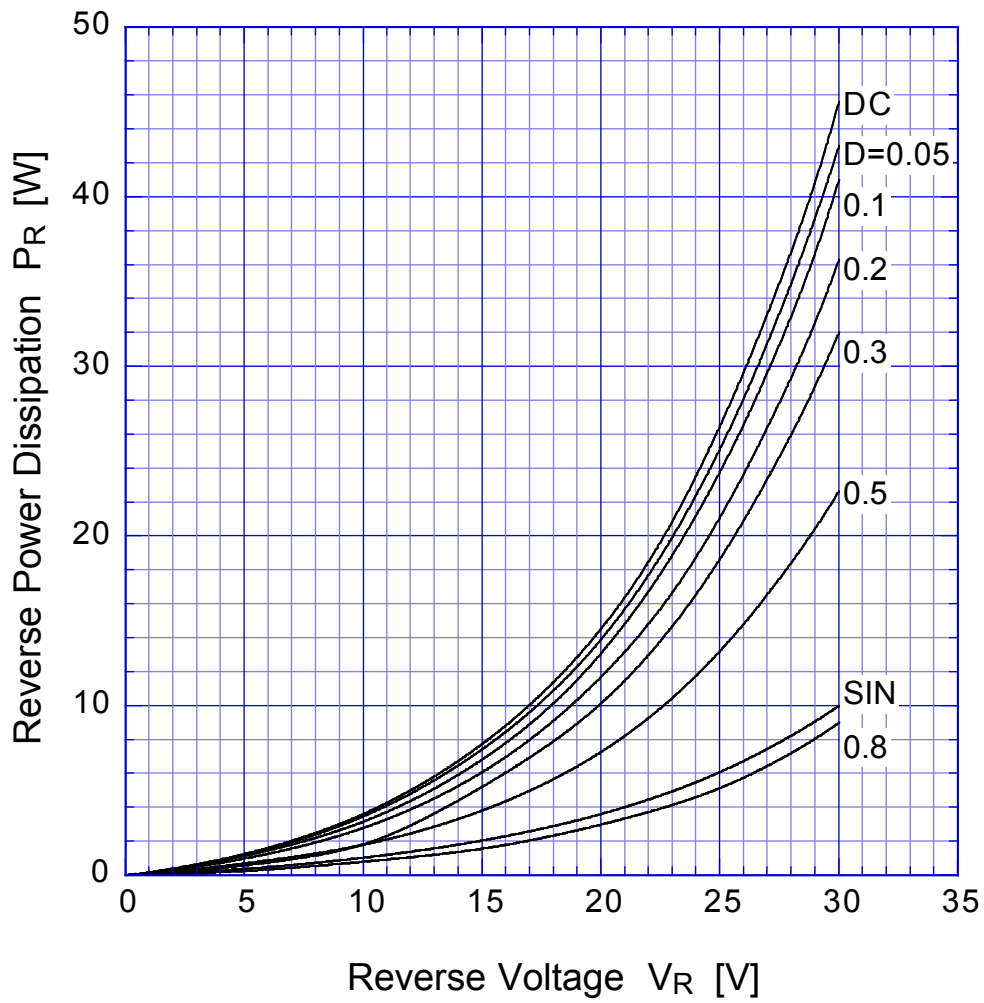

$T_j = 125^\circ\text{C}$

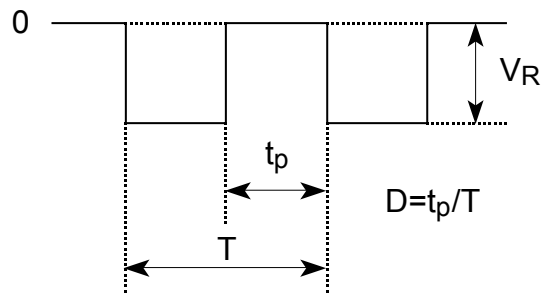

DE10P3

Forward Power Dissipation

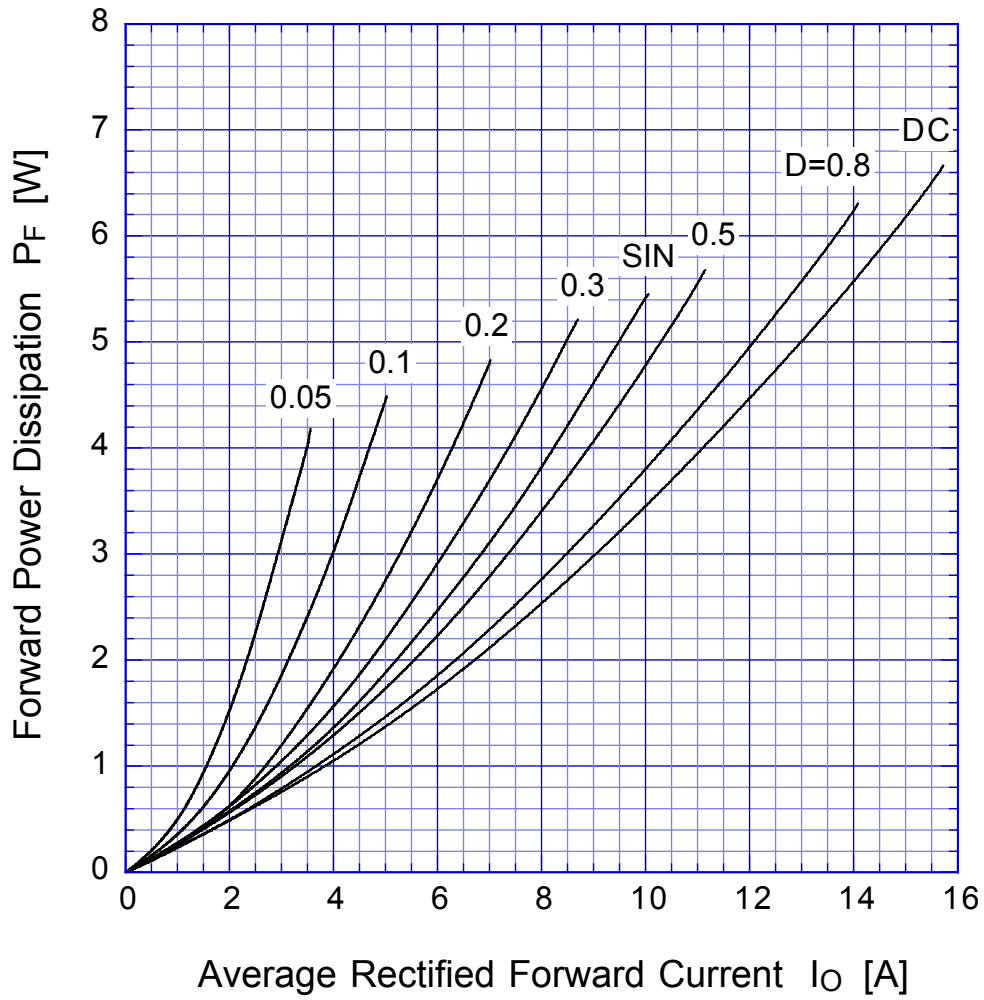

$T_j = 125^\circ\text{C}$

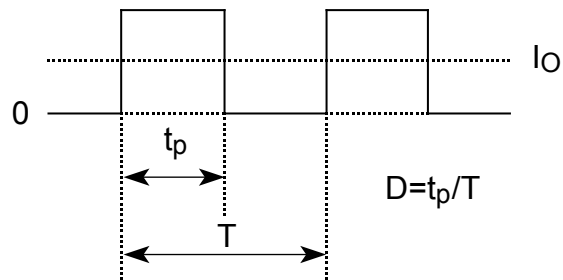

DE10P3

Derating Curve

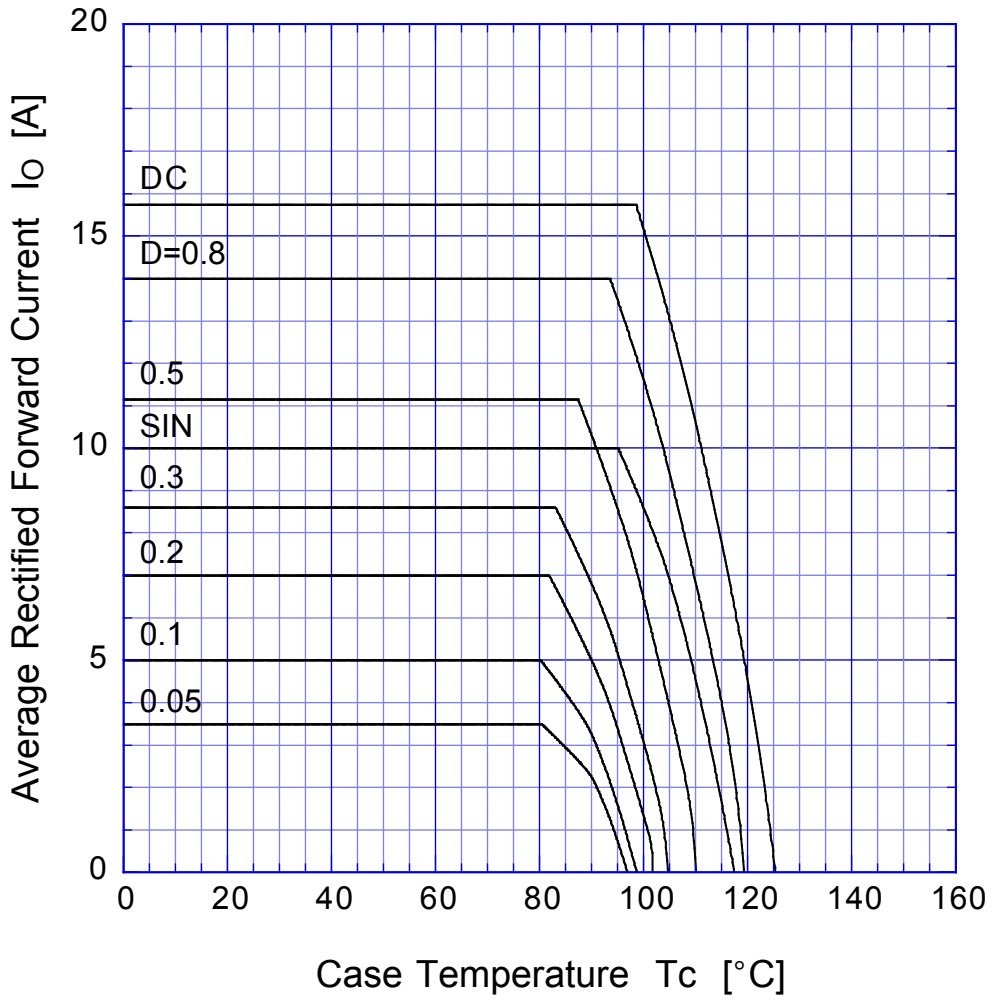

$V_R = 15V$

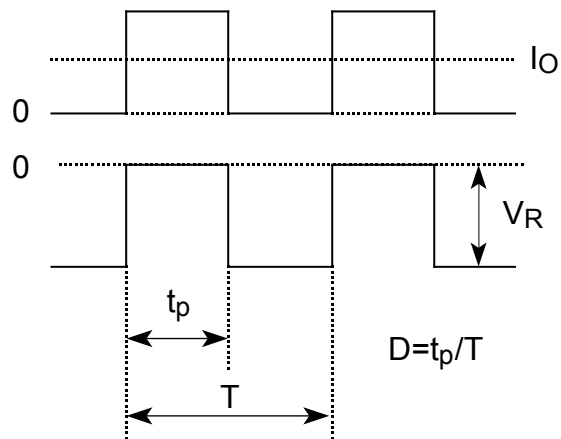

DE10P3

Peak Surge Forward Capability

