

BCR3PM

LOW POWER USE
INSULATED TYPE, PLANAR PASSIVATION TYPE

BCR3PM

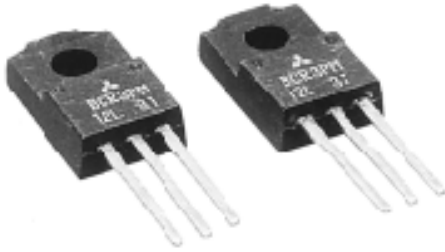

- **IT (RMS)** **3A**
- **VDRM** **400V/600V**
- **IFGT I , IRGT I , IRGT III** **30mA (10mA) *5**
- **Viso**..... **1500V**
- **UL Recognized: File No. E80276**

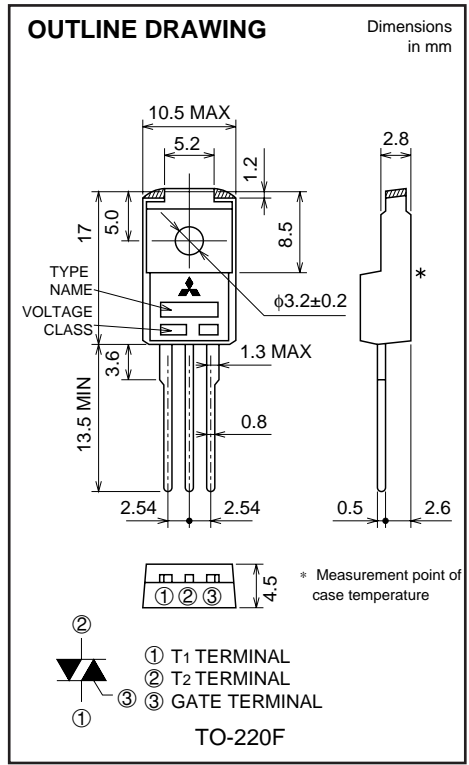

APPLICATION

Contactless AC switches, light dimmer, electric blankets, control of household equipment such as electric fan, solenoid drivers, small motor control, other general purpose control applications

MAXIMUM RATINGS

Symbol	Parameter	Voltage class		Unit
		8	12	
VDRM	Repetitive peak off-state voltage*1	400	600	V
VDSM	Non-repetitive peak off-state voltage*1	500	720	V

Symbol	Parameter	Conditions	Ratings	Unit
IT (RMS)	RMS on-state current	Commercial frequency, sine full wave 360° conduction, Tc=107°C	3.0	A
ITSM	Surge on-state current	60Hz sinewave 1 full cycle, peak value, non-repetitive	30	A
I ² t	I ² t for fusing	Value corresponding to 1 cycle of half wave 60Hz, surge on-state current	3.7	A ² s
PGM	Peak gate power dissipation		3	W
PG (AV)	Average gate power dissipation		0.3	W
VGM	Peak gate voltage		6	V
IGM	Peak gate current		0.5	A
Tj	Junction temperature		-40 ~ +125	°C
Tstg	Storage temperature		-40 ~ +125	°C
—	Weight	Typical value	2.0	g
Viso	Isolation voltage	Ta=25°C, AC 1 minute, T1 · T2 · G terminal to case	1500	V

*1. Gate open.

BCR3PM

LOW POWER USE
INSULATED TYPE, PLANAR PASSIVATION TYPE

ELECTRICAL CHARACTERISTICS

Symbol	Parameter	Test conditions	Limits			Unit	
			Min.	Typ.	Max.		
IDRM	Repetitive peak off-state current	T _j =125°C, V _{DRM} applied	—	—	2.0	mA	
V _{TM}	On-state voltage	T _c =25°C, I _{TM} =4.5A, Instantaneous measurement	—	—	1.5	V	
V _{FGT I}	Gate trigger voltage *2	T _j =25°C, V _D =6V, R _L =6Ω, R _G =330Ω	I	—	—	1.5	V
V _{RGT I}			II	—	—	1.5	V
V _{RGT III}			III	—	—	1.5	V
I _{FGT I}	Gate trigger current *2	T _j =25°C, V _D =6V, R _L =6Ω, R _G =330Ω	I	—	—	30*5	mA
I _{RGT I}			II	—	—	30*5	mA
I _{RGT III}			III	—	—	30*5	mA
V _{GD}	Gate non-trigger voltage	T _j =125°C, V _D =1/2V _{DRM}	0.2	—	—	V	
R _{th(j-c)}	Thermal resistance	Junction to case *4	—	—	4.5	°C/W	
(dv/dt) _c	Critical-rate of rise of off-state commutating voltage		*3	—	—	V/μs	

*2. Measurement using the gate trigger characteristics measurement circuit.
 *3. The critical-rate of rise of the off-state commutating voltage is shown in the table below.
 *4. The contact thermal resistance R_{th(c-f)} in case of greasing is 0.5°C/W.
 *5. High sensitivity (I_{GT}≤10mA) is also available.

Voltage class	V _{DRM} (V)	(dv/dt) _c		Test conditions	Commutating voltage and current waveforms (inductive load)
		Min.	Unit		
8	400	5	V/μs	1. Junction temperature T _j =125°C 2. Rate of decay of on-state commutating current (di/dt) _c =-1.5A/ms 3. Peak off-state voltage V _D =400V	
12	600				

PERFORMANCE CURVES

MAXIMUM ON-STATE CHARACTERISTICS

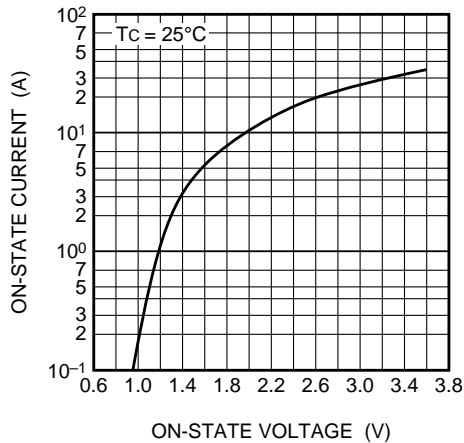

RATED SURGE ON-STATE CURRENT

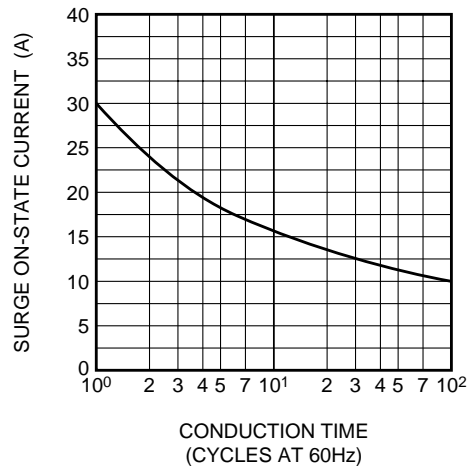

BCR3PM

LOW POWER USE
INSULATED TYPE, PLANAR PASSIVATION TYPE

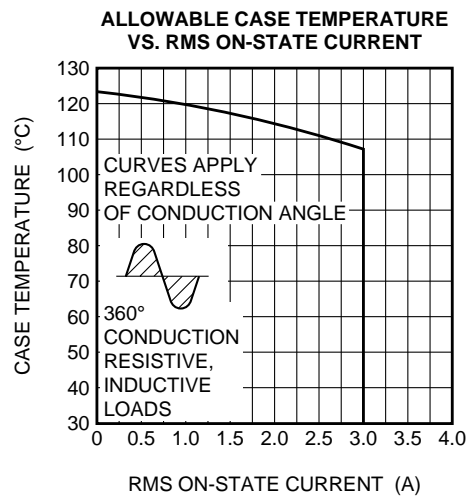
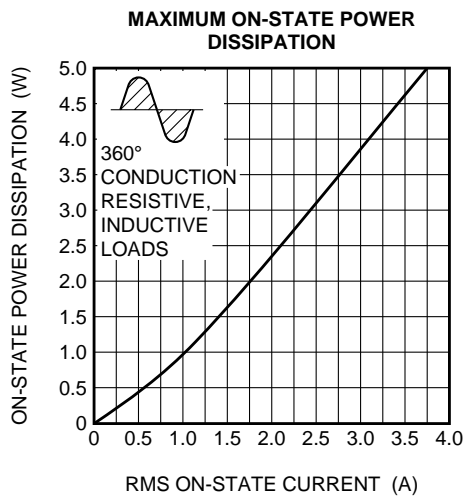
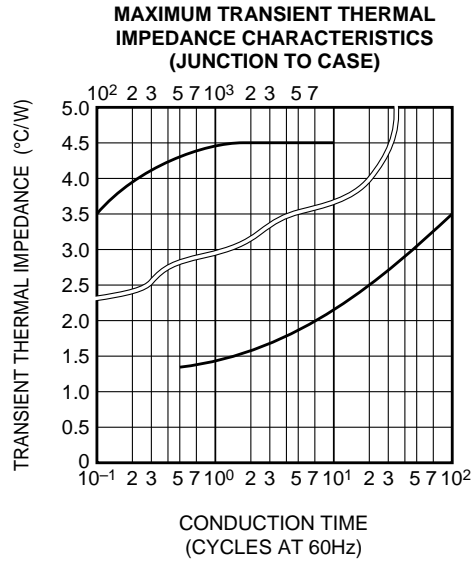
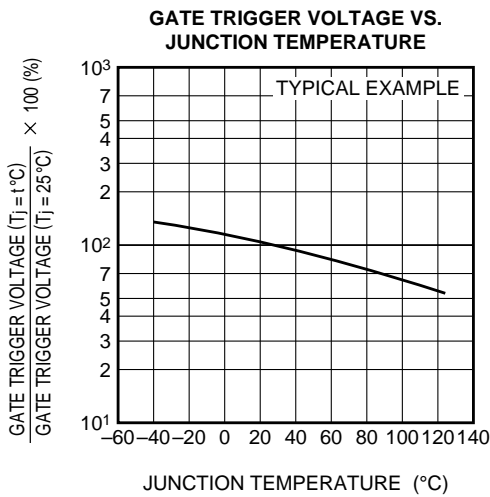
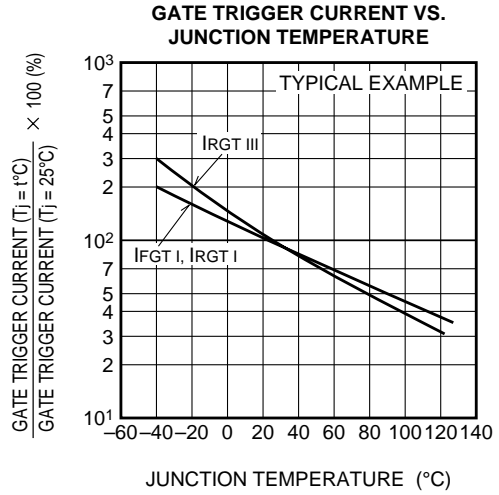
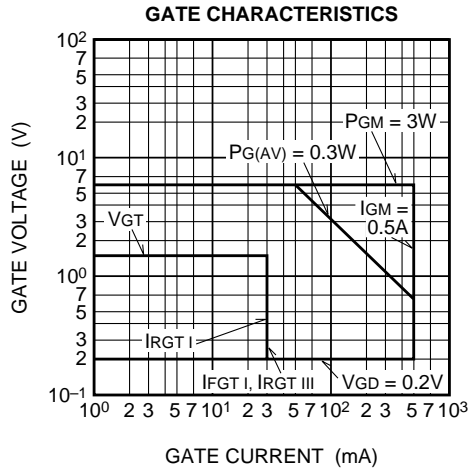

BCR3PM

LOW POWER USE
INSULATED TYPE, PLANAR PASSIVATION TYPE

ALLOWABLE AMBIENT TEMPERATURE VS. RMS ON-STATE CURRENT

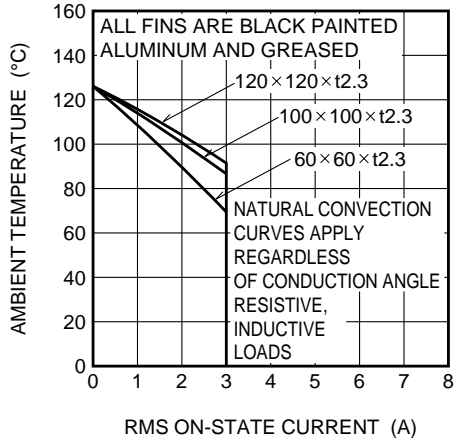

ALLOWABLE AMBIENT TEMPERATURE VS. RMS ON-STATE CURRENT

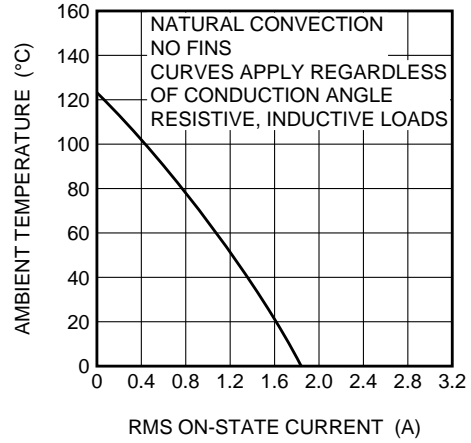

REPETITIVE PEAK OFF-STATE CURRENT VS. JUNCTION TEMPERATURE

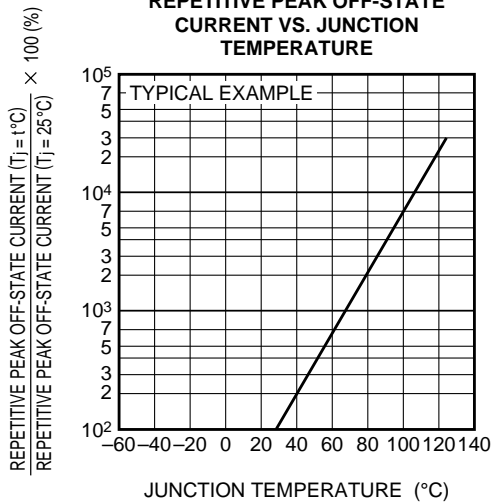

HOLDING CURRENT VS. JUNCTION TEMPERATURE

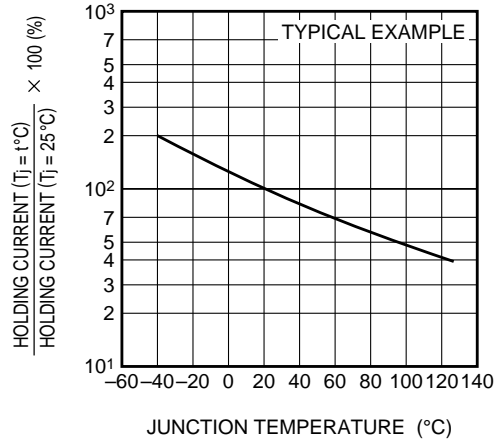

LATCHING CURRENT VS. JUNCTION TEMPERATURE

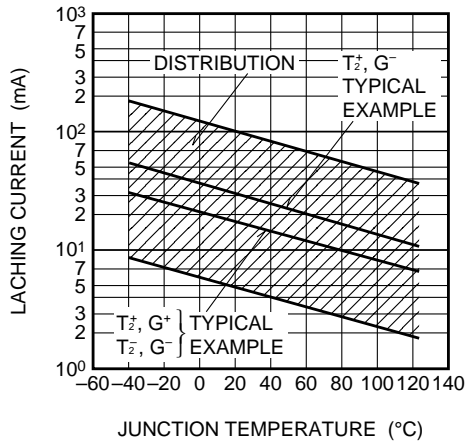

BREAKOVER VOLTAGE VS. JUNCTION TEMPERATURE

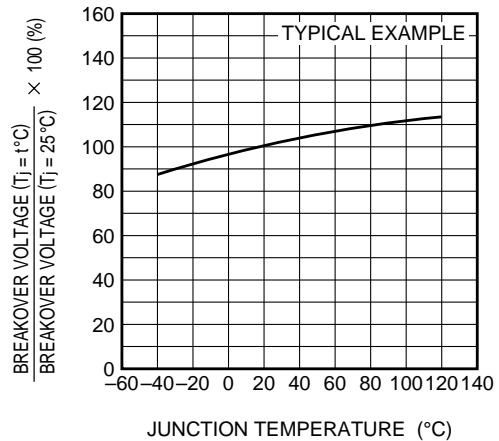

BCR3PM

LOW POWER USE
INSULATED TYPE, PLANAR PASSIVATION TYPE

BREAKOVER VOLTAGE VS. RATE OF RISE OF OFF-STATE VOLTAGE

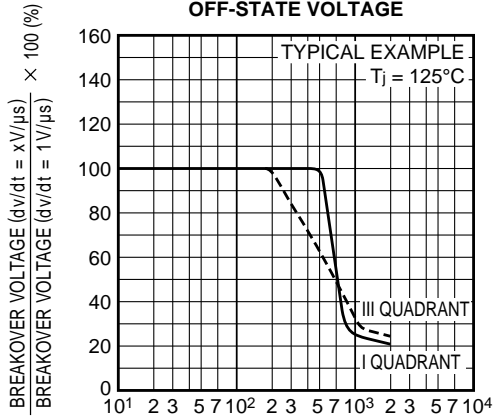

RATE OF RISE OF OFF-STATE VOLTAGE (V/μs)

COMMUTATION CHARACTERISTICS

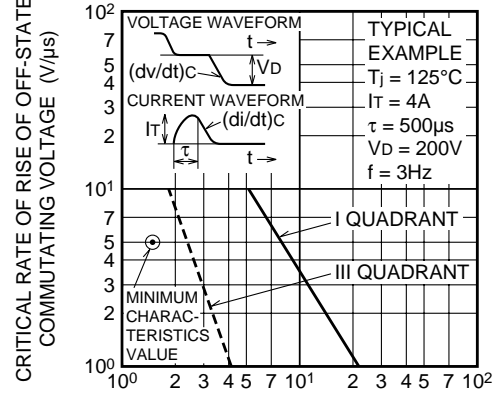

RATE OF DECAY OF ON-STATE COMMUTATING CURRENT (A/ms)

GATE TRIGGER CURRENT VS. GATE CURRENT PULSE WIDTH

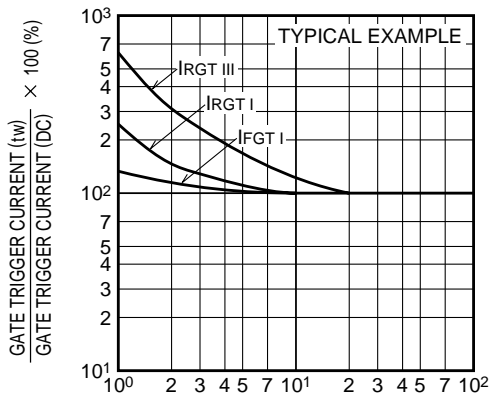

GATE CURRENT PULSE WIDTH (μs)

GATE TRIGGER CHARACTERISTICS TEST CIRCUITS

