

POSEICO SPA
Power SEmiconductors Italian COporation

POSEICO SPA
Via N. Lorenzi 8, 16152 Genova - ITALY
Tel. ++ 39 010 6556234 - Fax ++ 39 010 6557519
Sales Office:
Tel. ++ 39 010 6556775 - Fax ++ 39 010 6442510

FAST RECOVERY DIODE

ARF674

Repetitive voltage up to

4500 V

Mean forward current

945 A

Surge current

15 kA

FINAL SPECIFICATION

feb 97 - ISSUE : 03

Symbol	Characteristic	Conditions	T _j [°C]	Value	Unit
BLOCKING					
V _{RRM}	Repetitive peak reverse voltage		125	4500	V
V _{RSM}	Non-repetitive peak reverse voltage		125	4600	V
I _{RRM}	Repetitive peak reverse current	V=VRRM	125	80	mA
CONDUCTING					
I _{F(AV)}	Mean forward current	180° sin ,50 Hz, Th=55°C, double side cooled		945	A
I _{F(AV)}	Mean forward current	180° square,50 Hz,Th=55°C,double side cooled		940	A
I _{FSM}	Surge forward current	Sine wave, 10 ms reapplied reverse voltage up to 50% VRSM	125	15	kA
I ² t	I ² t			1125 x1E3	A ² s
V _{FM}	Forward voltage	Forward current = 1570 A	25	3	V
V _{F(TO)}	Threshold voltage		125	1.90	V
r _F	Forward slope resistance		125	0.700	mohm
SWITCHING					
t _{rr}	Reverse recovery time	I _F = 500 A di/dt= 30 A/μs VR = 100 V	125	8	μs
Q _{rr}	Reverse recovery charge			600	μC
I _{rr}	Peak reverse recovery current			150	A
s	Softness (s-factor), min			0.4	
V _{FR}	Peak forward recovery	di/dt= 400 A/μs		42	V
MOUNTING					
R _{th(j-h)}	Thermal impedance	Junction to heatsink, double side cooled		21	°C/kW
T _j	Operating junction temperature			-30 / 125	°C
F	Mounting force			22.0 / 24.5	kN
	Mass			520	g

ORDERING INFORMATION : ARF674 S 45

standard specification VRRM/100

DISSIPATION CHARACTERISTICS

SQUARE WAVE

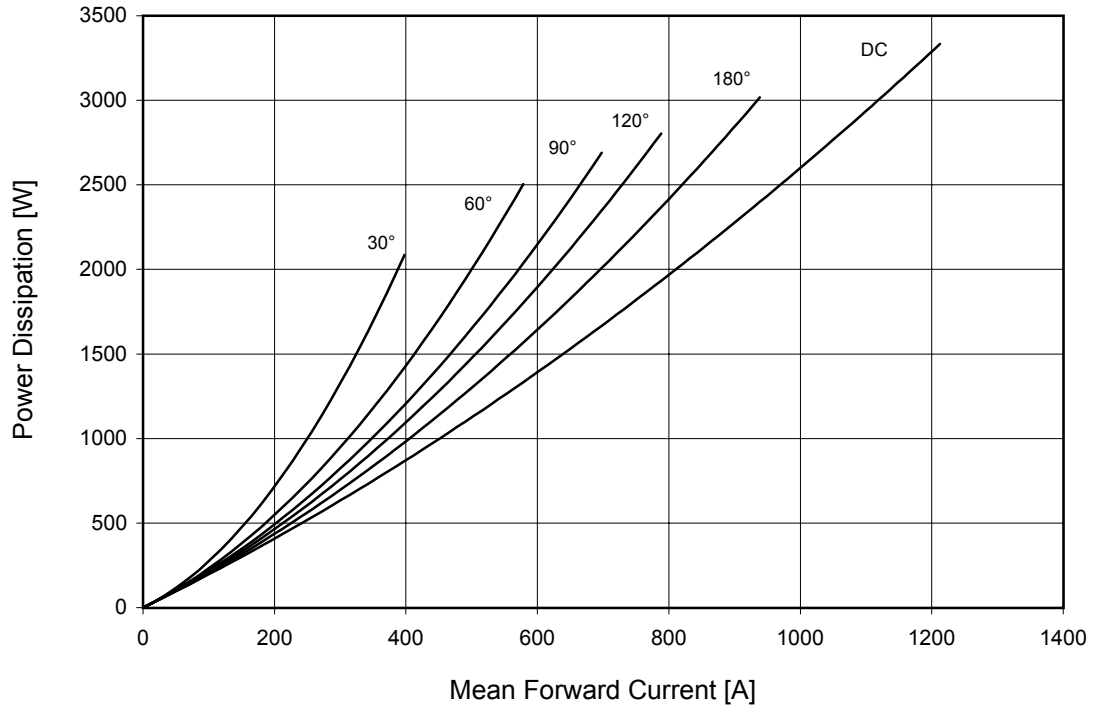

SINE WAVE

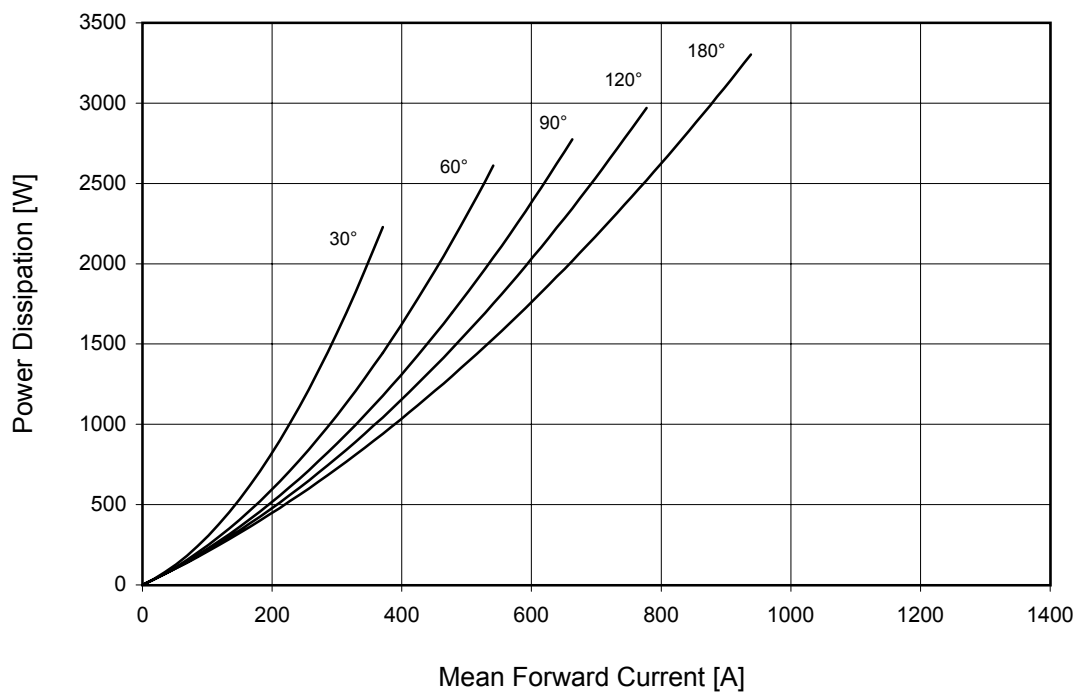

SWITCHING CHARACTERISTICS

FORWARD RECOVERY VOLTAGE

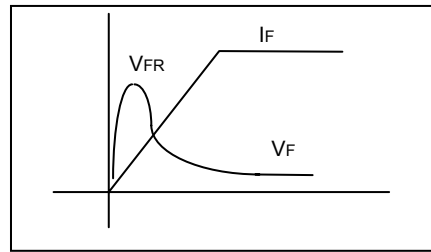
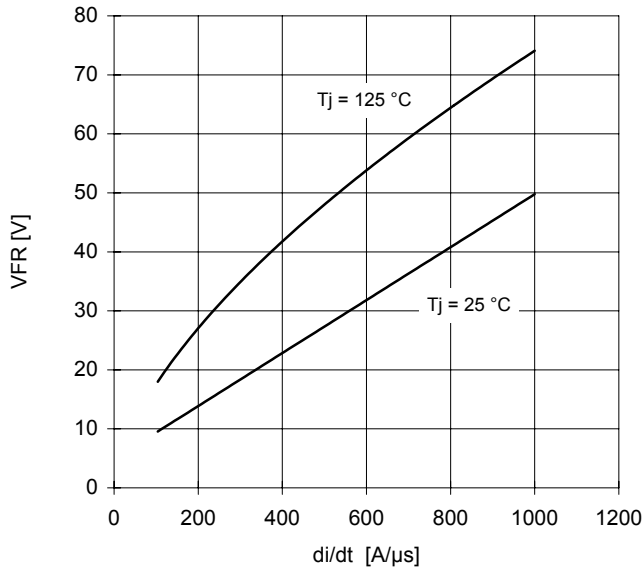

REVERSE RECOVERY CHARGE Tj = 125 °C

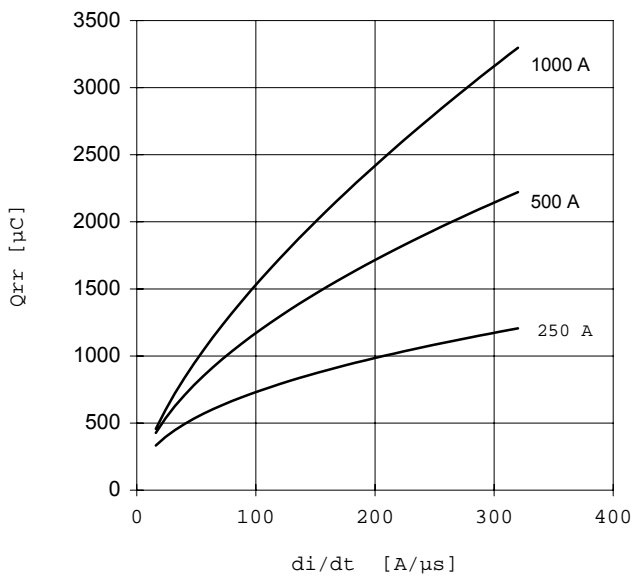

REVERSE RECOVERY CURRENT Tj = 125 °C

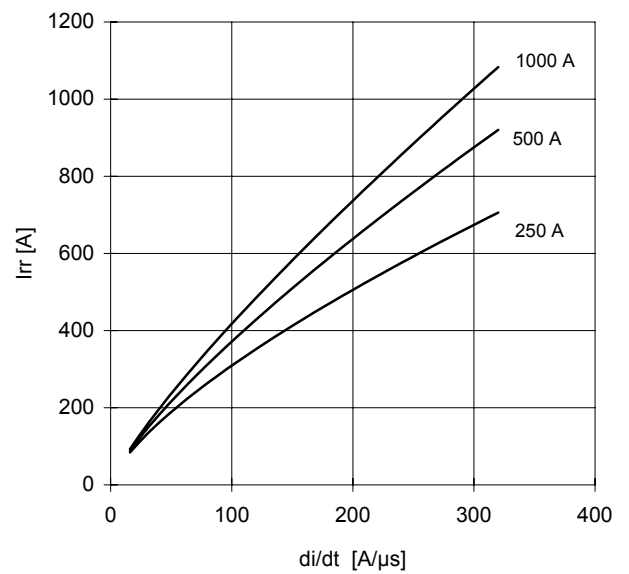

$$t_a = I_{rr} / (di/dt) \quad t_b = t_{rr} - t_a$$

$$\text{Softness (s factor)} \quad s = t_b / t_a$$

$$\text{Energy dissipation during recovery } E_r = V_r \cdot (Q_{rr} - I_{rr} \cdot t_a / 2)$$

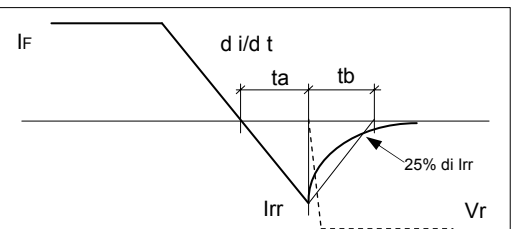

ARF674 FAST RECOVERY DIODE



FINAL SPECIFICATION feb 97 - ISSUE : 03

FORWARD CHARACTERISTIC
T_j = 125 °C

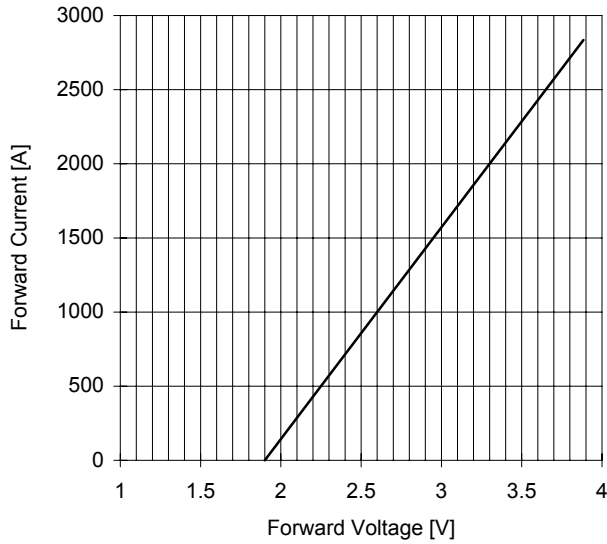

SURGE CHARACTERISTIC
T_j = 125 °C

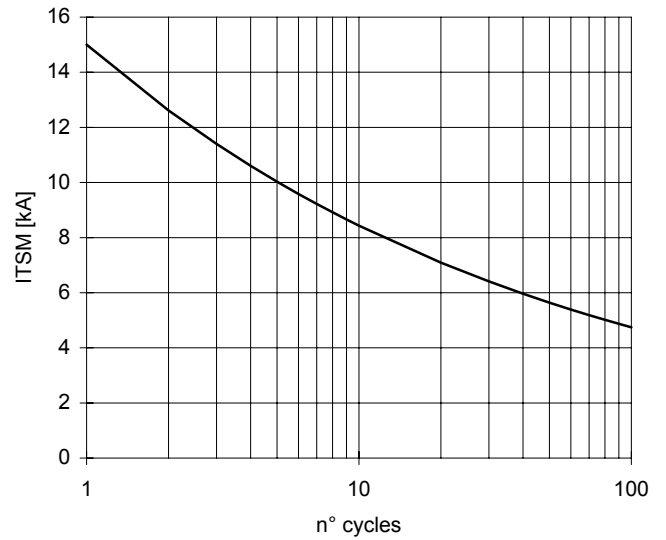

TRANSIENT THERMAL IMPEDANCE
DOUBLE SIDE COOLED

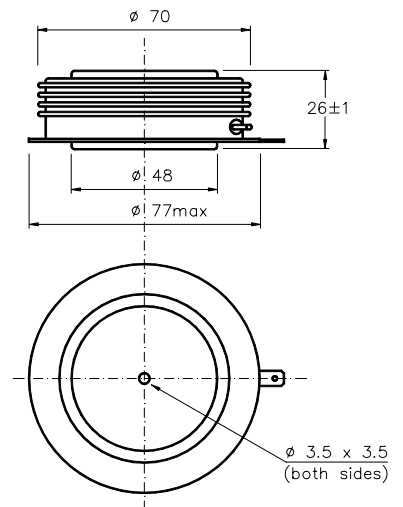
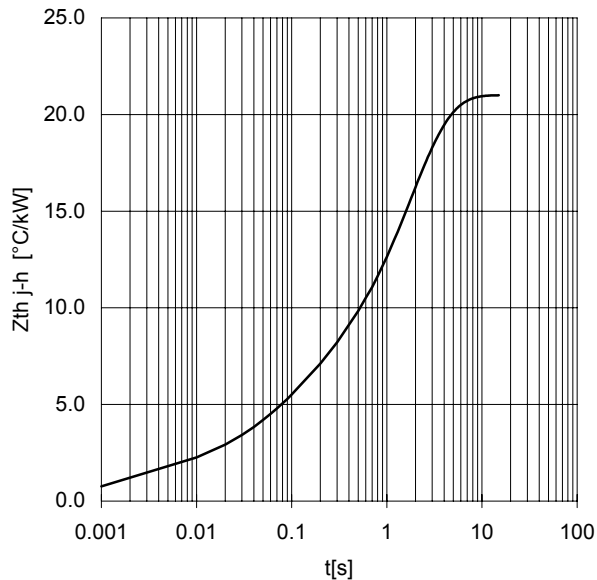

Dimensions
in mm



All the characteristics given in this data sheet are guaranteed only with uniform clamping force, cleaned and lubricated heatsink, surfaces with flatness < .03 mm and roughness < 2 μm.

In the interest of product improvement POSEICO SPA reserves the right to change any data given in this data sheet at any time without previous notice.

If not stated otherwise the maximum value of ratings (symbols over shaded background) and characteristics is reported.

Distributed by

