

### FEATURES

- Normally Close, Single Pole Single Throw
- Control 400 VAC or DC Voltage
- Switch 130 mA Loads
- LED Control Current, 2mA
- Low ON-Resistance
- $dv/dt$ , >500 V/ms
- Isolation Test Voltage, 1500 VAC<sub>RMS</sub>
- UL, CSA, FCC compatible
- Applications
  - Telecommunications
    - Telecom Switching
    - Tip/Ring Circuits
    - Modem Switching (Laptop, Notebook, Pocket Size)
    - Hookswitch
    - Dial Pulsing
    - Ground Start
    - Ringer Injection
  - Instrumentation
    - Multiplexers
    - Data Acquisition
    - Electronic Switching
    - I/O Subsystems
    - Meters (Watt-Hour, Water, Gas)
    - Medical Equipment
  - High Voltage Test Equipment
  - TRIAC Driver
  - Motor Control
  - Security
  - Aerospace
  - Industrial Controls

### DESCRIPTION

The AQY414S is a single pole single throw (SPST), normally close (NC), Mos Relay. The relay can control AC or DC loads currents up to 130 mA, with a supply voltage up to 400 V. The device is packaged in a 4 pin SO package. This package offers an insulation dielectric withstand of 1500 VAC<sub>RMS</sub>.

The coupler consists of a AlGaAs LED that is optically coupled to a dielectrically isolated photodiode array which drives two series connected high voltage MOS transistors. The typical ON-Resistance is 40Ω at 25 mA and is linear up to 50mA. The incremental resistance drops to less than 40Ω beyond 50 mA while reducing internal power dissipation at high load currents.

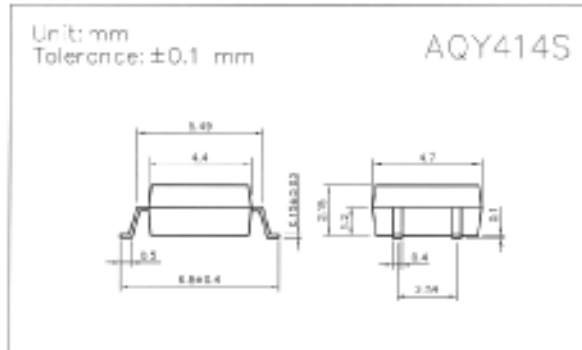

### Absolute Maximum Ratings (T<sub>A</sub> = 25°C)

#### Emitter (Input)

Reverse Voltage.....	5.0V
Continuous Forward Current.....	50mA
Peak Forward Current (1s).....	1A
Power Dissipation.....	100mW
Derate Linearly from 25°C.....	1.3mW/°C

#### Detector (Output)

Output Breakdown Voltage.....	±400V
Continuous Load Current.....	±130mA
Power Dissipation.....	500mW

#### General Characteristics

Isolation Test Voltage.....	1500VAC <sub>RMS</sub>
Isolation Resistance	
V <sub>IO</sub> = 500V, T <sub>A</sub> = 25°C.....	≥10 <sup>10</sup> Ω
Total Power Dissipation.....	550mW
Derate Linearly from 25°C.....	2.5mW/°C
Storage Temperature Range.....	-40 to +150°C
Operating Temperature Range.....	-40 to +85°C
Junction Temperature.....	100°C
Soldering Temperature, 2mm from case, 10 sec... ..	260°C

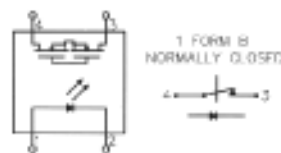
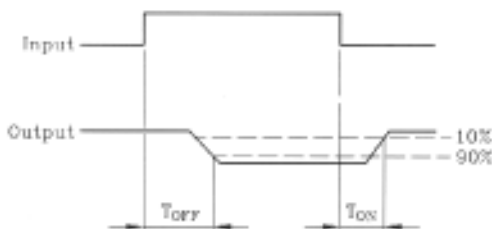

### ● Operate/Reverse time



Characteristics

( $T_A = 25^\circ\text{C}$ )

Description	Symbol	Min.	Typ.	Max.	Unit	Test Condition
<b>Emitter (Input)</b>						
Forward Voltage	$V_F$		1.8	2.0	V	$I_F = 10 \text{ mA}$
Operation Input Current	$I_{FOFF}$			5	mA	$V_L = \pm 20 \text{ V}, I_L = < 5 \mu\text{A}$
Recovery Input Current	$I_{FON}$	0.2			mA	$V_L = \pm 20 \text{ V}, I_L = 100 \text{ mA}, t = 10 \text{ ms}$
<b>Detector (output)</b>						
Output Breakdown Voltage	$V_B$	400			V	$I_B = 50 \mu\text{A}$
Output Off-State Leakage	$I_{T(OFF)}$		0.2	1	$\mu\text{A}$	$V_T = 100 \text{ V}, I_F = 10 \text{ mA}$
I/O Capacitance	$C_{ISO}$		6		pF	$I_R = 0, f = 1 \text{ MHz}$
ON Resistance	$R_{ON}$		40	50	$\Omega$	$I_L = 100 \text{ mA}, I_F = 0 \text{ mA}$
Reverse (ON) Time	$T_{ON}$		0.6	1.5	ms	$I_F = 10 \text{ mA}, V_L = \pm 20 \text{ V}$
Operate (OFF) Time	$T_{OFF}$		0.3	1.0	ms	$t = 10 \text{ ms}, I_L = \pm 100 \text{ mA}$

Mos Relay Schematic and Wiring Diagrams					
Type	Schematic	Output configuration	Load	Con-nection	Wiring diagram
AQY414S		1b	AC/DC	-	

DATA CURVE

Load current vs. ambient temperature  
 Allowable ambient temperature:  
 $-40^\circ\text{C}$  to  $+85^\circ\text{C}$

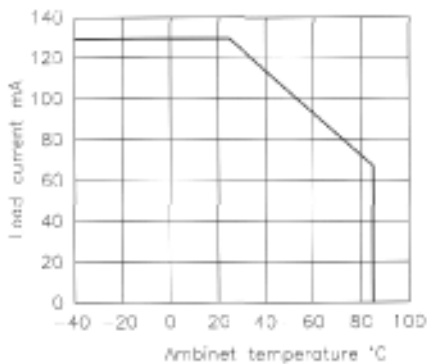

On resistance vs. ambient temperature  
 Across terminals 3 and 4 pin  
 LED current: 5 mA  
 Continuous load current: 130 mA(DC)

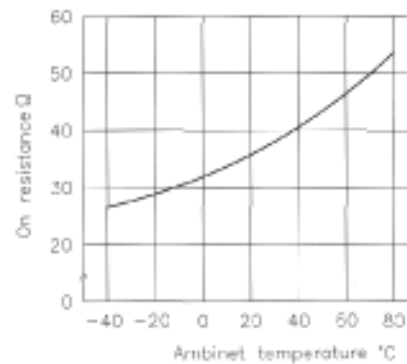

Operate (OFF) time vs. ambient temperature;  
 Load voltage 400 V(DC)  
 LED current : 5 mA  
 Continuous load current: 130 mA(DC)

