

Power Metal Film Resistor
2 Watt
1% & 5%

5083NW Series
(2306 198.....)

FEATURES

Small Body
 Wide Resistance Range

DESCRIPTION

A homogeneous film of metal alloy is deposited on a high grade ceramic body. After a helical groove has been cut in the resistive layer; solder plated, copper or copper clad steel leads are welded onto the end caps. The resistors are coated with a red, nonflammable lacquer which provides electrical, mechanical, and climatic protection. The encapsulation is resistant to all cleaning solvents in accordance with MIL-STD-202E, Method 215, and IEC 68-2-45.

Note: This encapsulating lacquer is not resistant to aggressive fluxes.

MASS: 40 g per 100 units

MOUNTING:

The resistors are suitable for processing on automatic insertion equipment in addition to cutting and bending machines. The minimum bending for this series is 13 mm (.511").

QUICK REFERENCE DATA

	0.8 mm Cu-Lead	0.6 mm FeCu-Lead
Resistance Range	10 Ω to 1 M Ω ; E24/96 Series 0.33 Ω to 1M Ω ; E24 Series	1 Ω to 1 M Ω E24 Series
Resistance Tolerance (See Note 1)	\pm 5% (E24)	\pm 5% (E24)
Temperature Coefficient	\pm 250 ppm/ $^{\circ}$ C	
Abs. Max. Dissipation at T _{amb} = 70 $^{\circ}$ C 0.33 Ω to < 1 Ω 1 Ω to 1 M Ω	1.20 W 2.00 W	1.30 W
Max. Continuous Operating Voltage	500 V (DC or RMS)	
Operating Temperature Range	-55 $^{\circ}$ C to +155 $^{\circ}$ C	
Basic Specification	IEC 115-1 and 115-4	
Stability (Δ R/R max) after: 1000 HR. Load Climatic Tests Soldering	\pm 5.0% +0.1 Ω \pm 3.0% +0.1 Ω \pm 1.0% +0.05 Ω	

Note 1: The 5083NW is available in \pm 1% tolerance as a special only.

Power Metal Film Resistor
2 Watt
1% & 5%

5083NW Series
(2306 198.....)

MARKING

The nominal resistance and tolerance are marked on the resistors with a four band color code for 5% tolerance resistors and five band color code for 1% tolerance as described in "General Introduction—Leaded Resistors".

ELECTRICAL DATA

Standard values of nominal resistance are taken from the E24 series for resistors with a $\pm 5\%$ tolerance of, and E24/96 for resistors with a $\pm 1\%$ tolerance. A decade chart is located inside the back cover.

The maximum continuous working voltage, or limiting voltage, is 500 V (DC or RMS). This is the maximum voltage that may be continuously applied to the resistor element.

DISSIPATION

Maximum power dissipation as a function of ambient temperature is shown in Figure 2. The Hot-Spot Temperature rise (ΔT) as a function of dissipated power is shown in Figs. 3 and 4. The temperature rise (ΔT) at the soldering point as a function of various lead lengths after mounting is shown in Figs. 5 and 6.

Mechanical Data

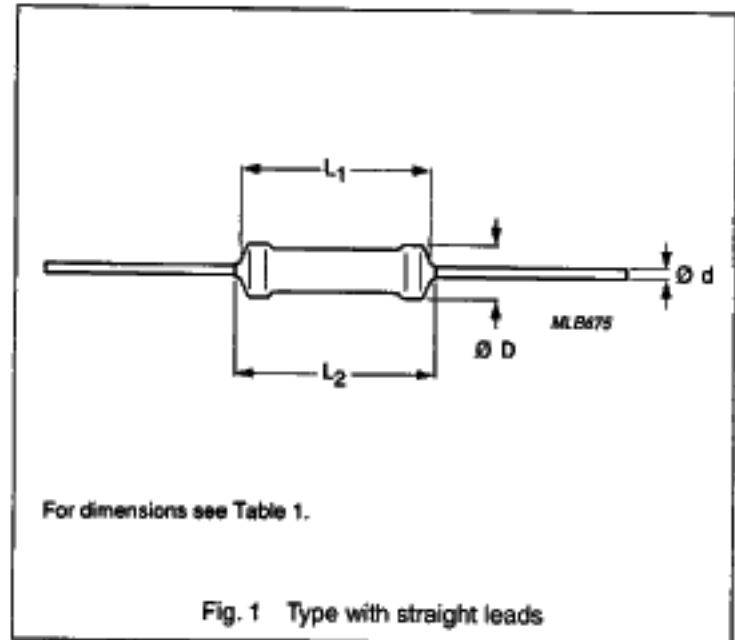
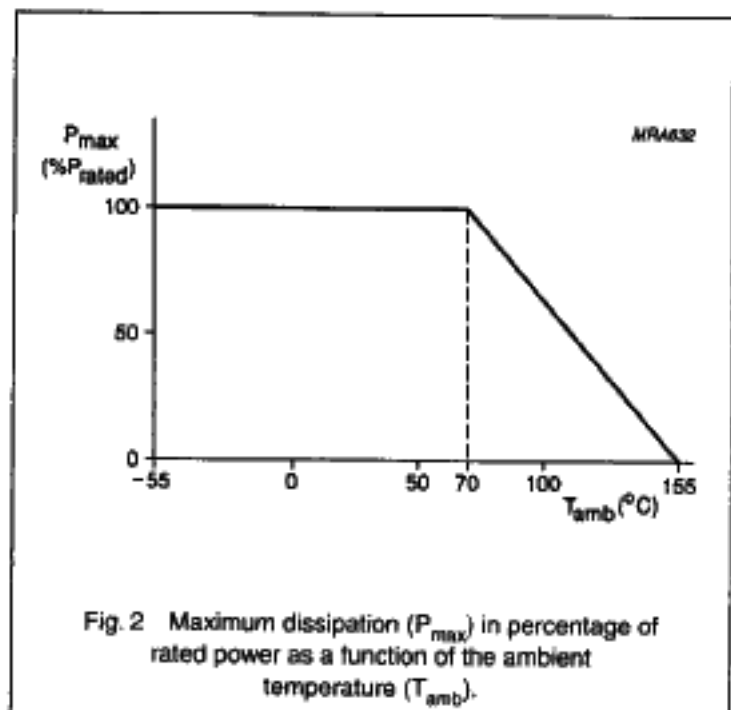

Table 1 Component Dimensions in inches (mm)
 FeCu Leads are 0.24" (0.60 mm) in diameter.

TYPE	D_{max}	L_{1max}	L_{2max}	d (Nom.)
5083NW	.154" (3.9)	.394" (10)	.472" (12)	.031" (.80)



Power Metal Film Resistor
2 Watt
1% & 5%

5083NW Series
(2306 198.....)

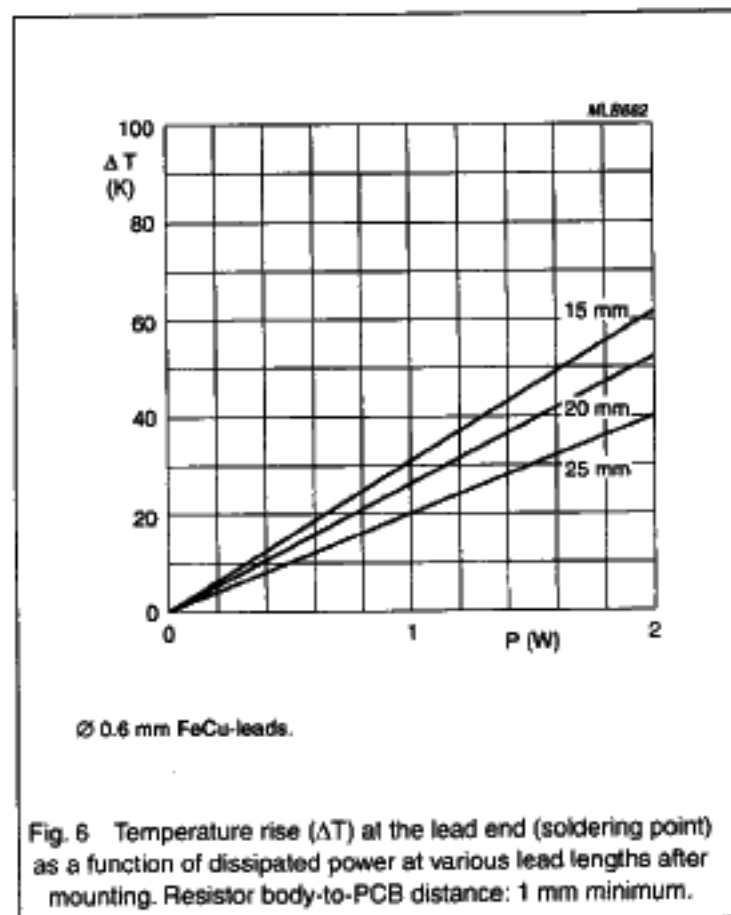
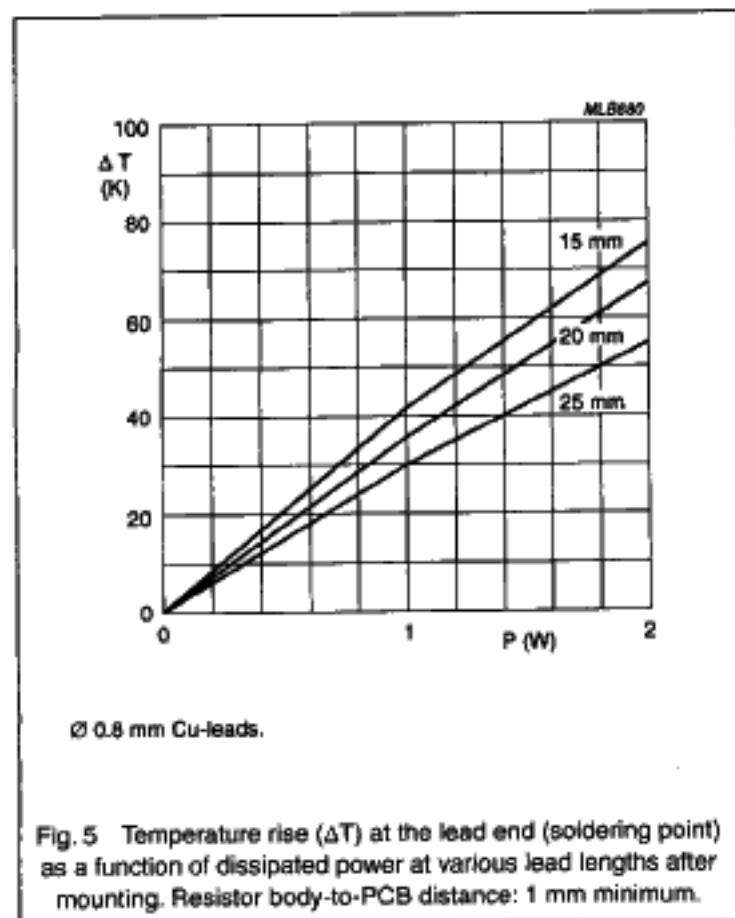
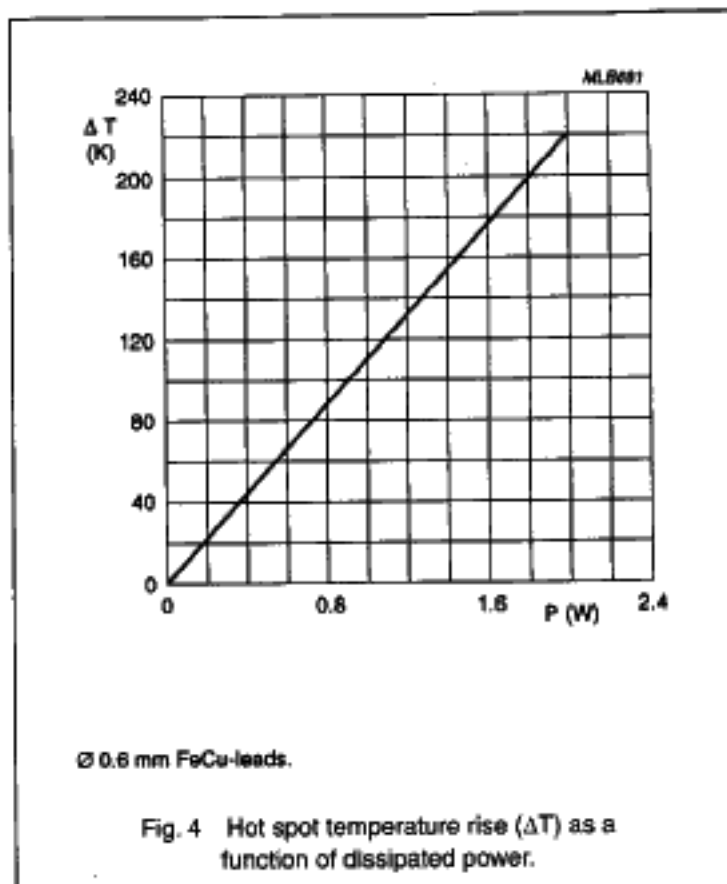
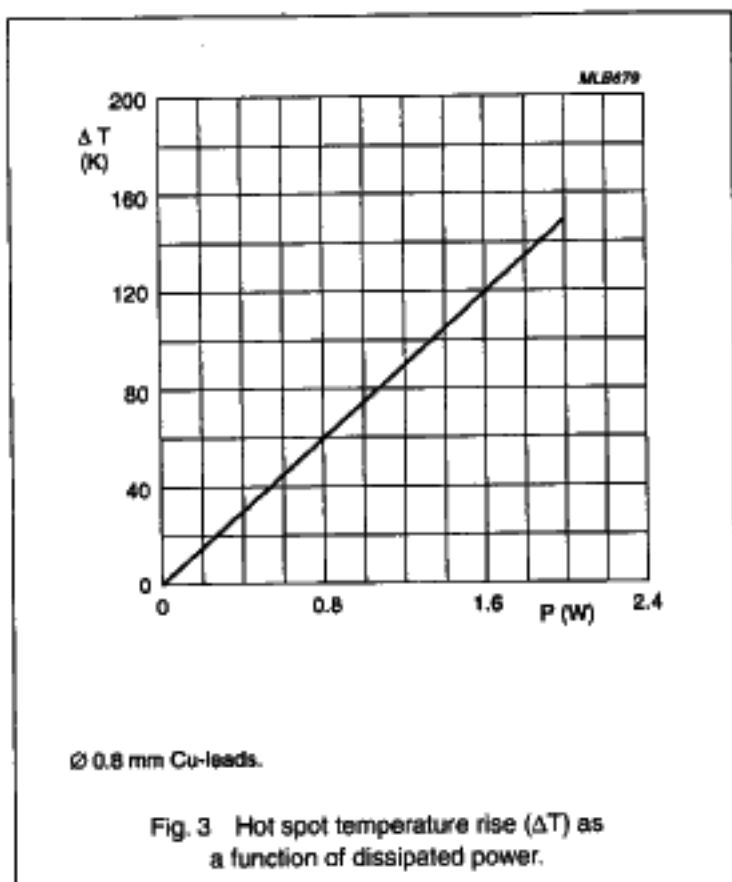

Power Metal Film Resistor
2 Watt
1% & 5%

5083NW Series
(2306 198.....)

PULSE LOAD BEHAVIOR

The Pulse Load Behavior is determined in accordance with the method outlined in the "General Section" for Leaded Resistors. The graphs for the 5083NW Series can be found in Fig. 8 and 9.

OTHER PERFORMANCE SPECIFICATIONS

The Drift Nomogram as described in the "General Section" for Leaded resistors can be found in Fig. 7.

The time to interruption as a function of overload for different value ranges can be found in Fig. 10, 11, and 12.

High Frequency Performance shown as Impedance as a function of applied frequency and Phase Angle as a function of applied frequency can be found in Fig. 13 and 14.

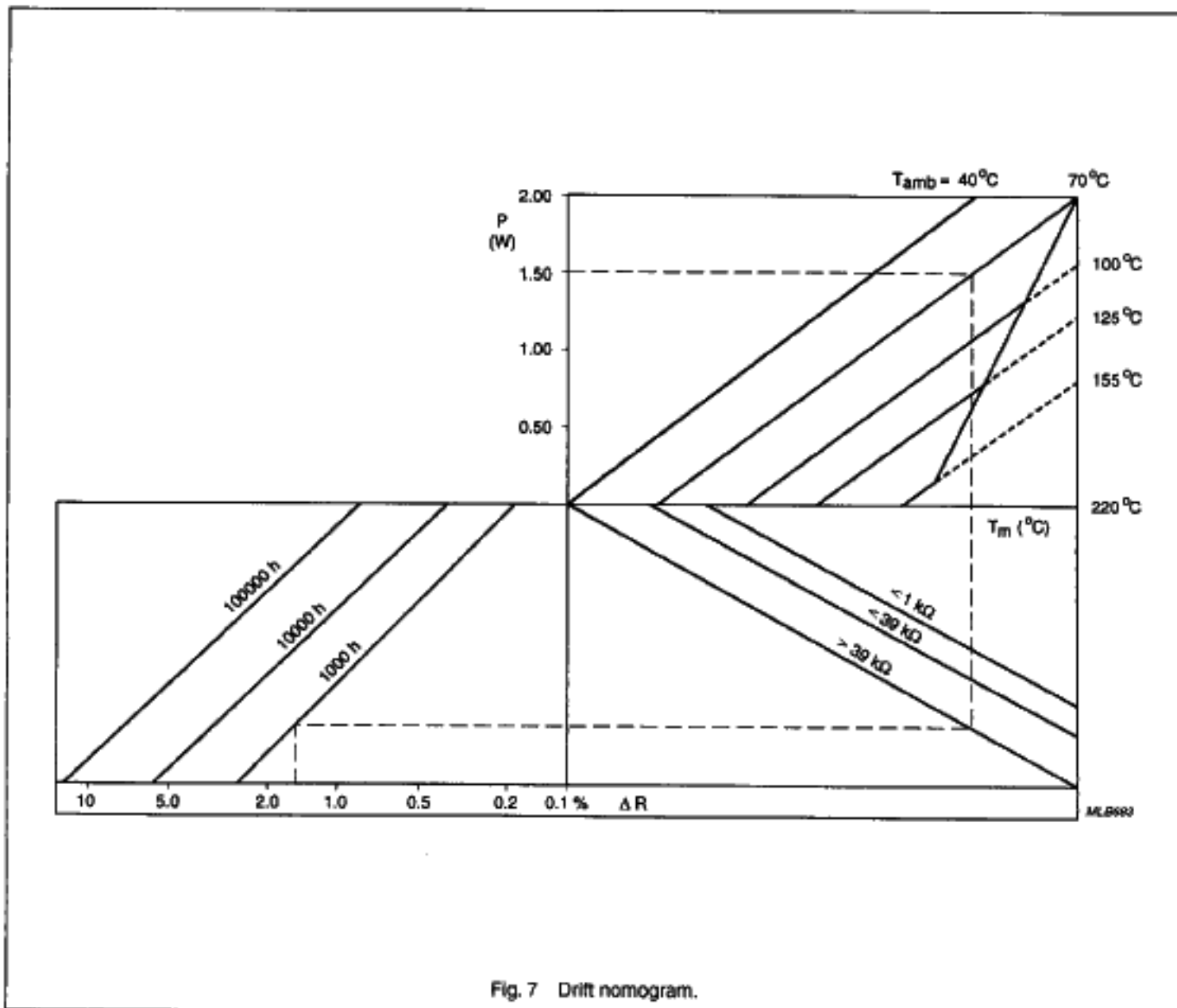

Fig. 7 Drift nomogram.

Power Metal Film Resistor
2 Watt
1% & 5%

5083NW Series
(2306 198.....)

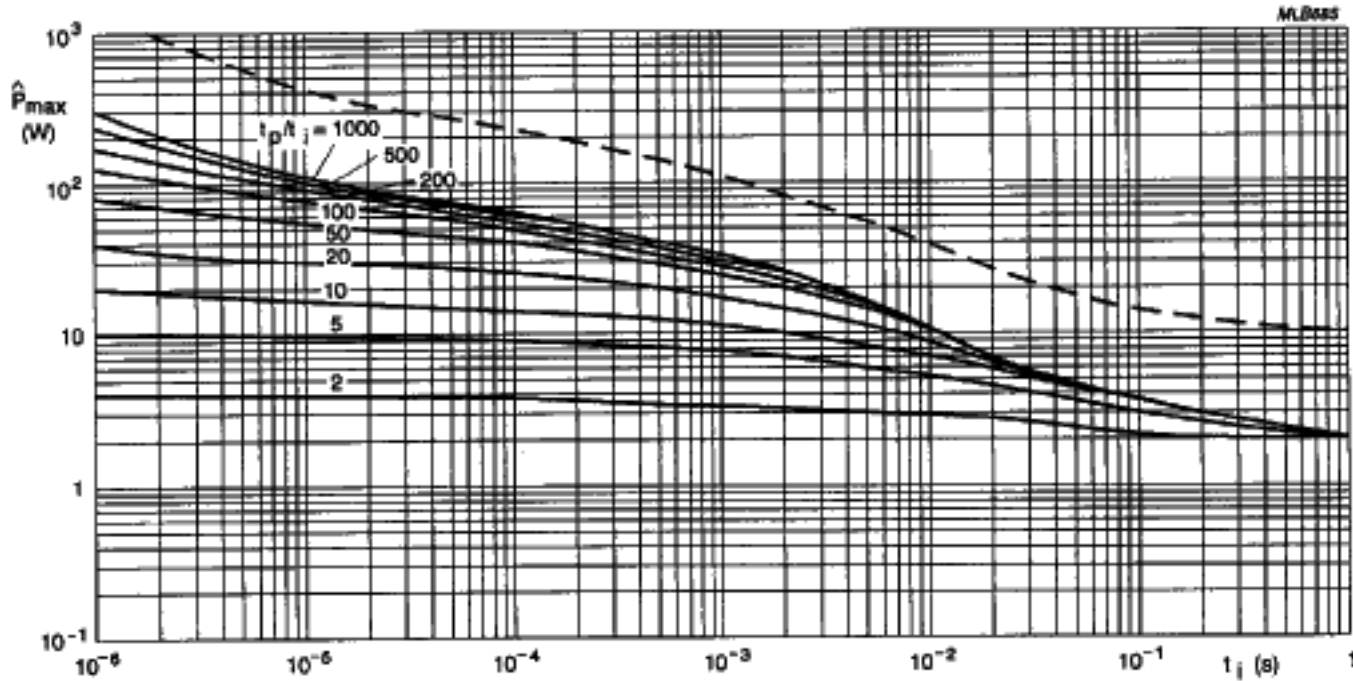

Fig. 8 Pulse on a regular basis; maximum permissible peak pulse power (\hat{P}_{max}) as a function of pulse duration (t_i).

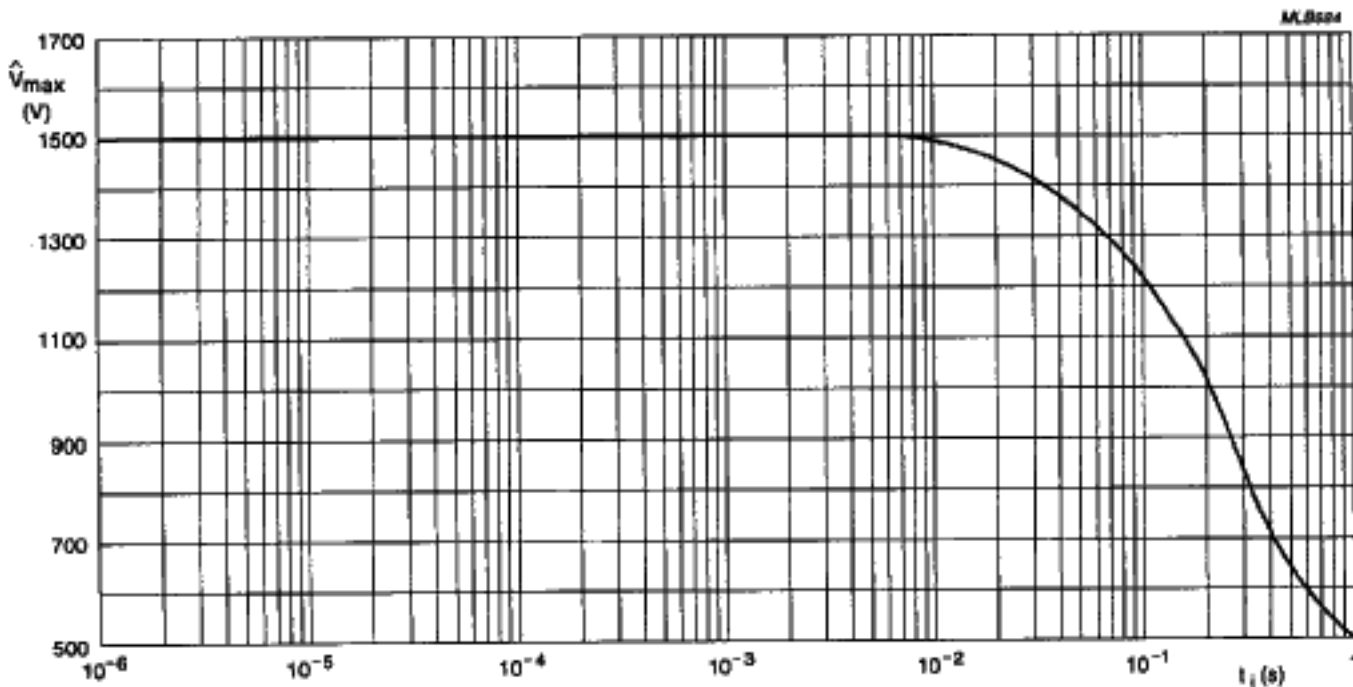
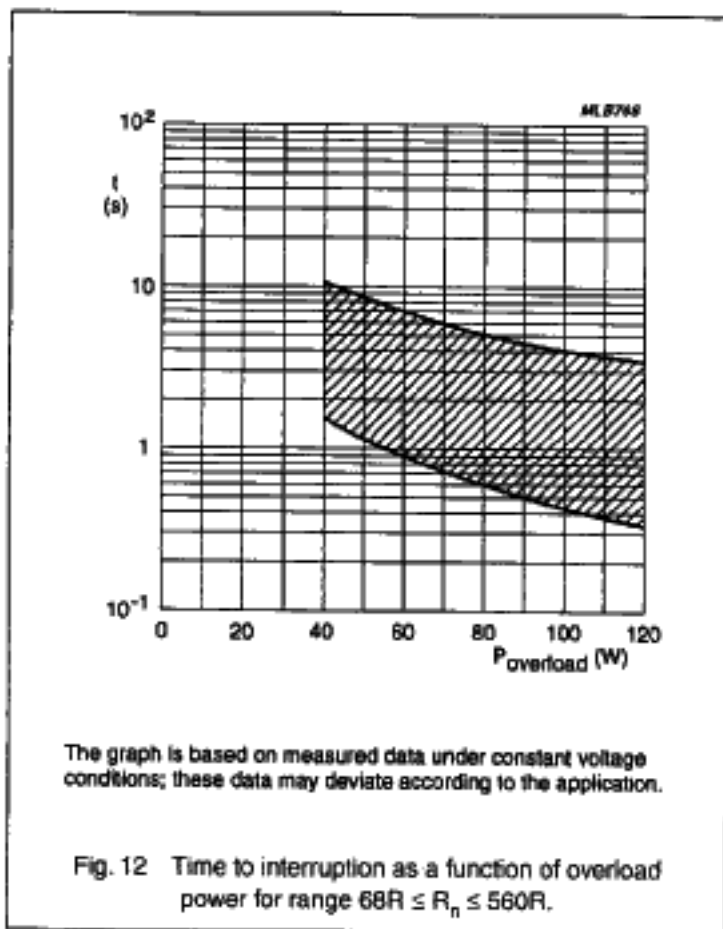
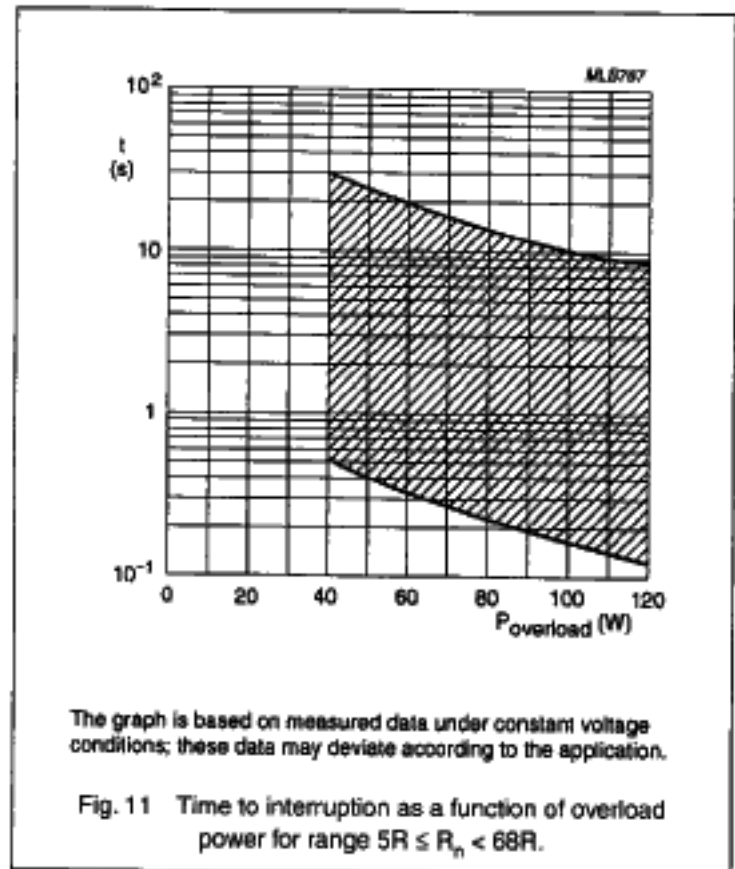
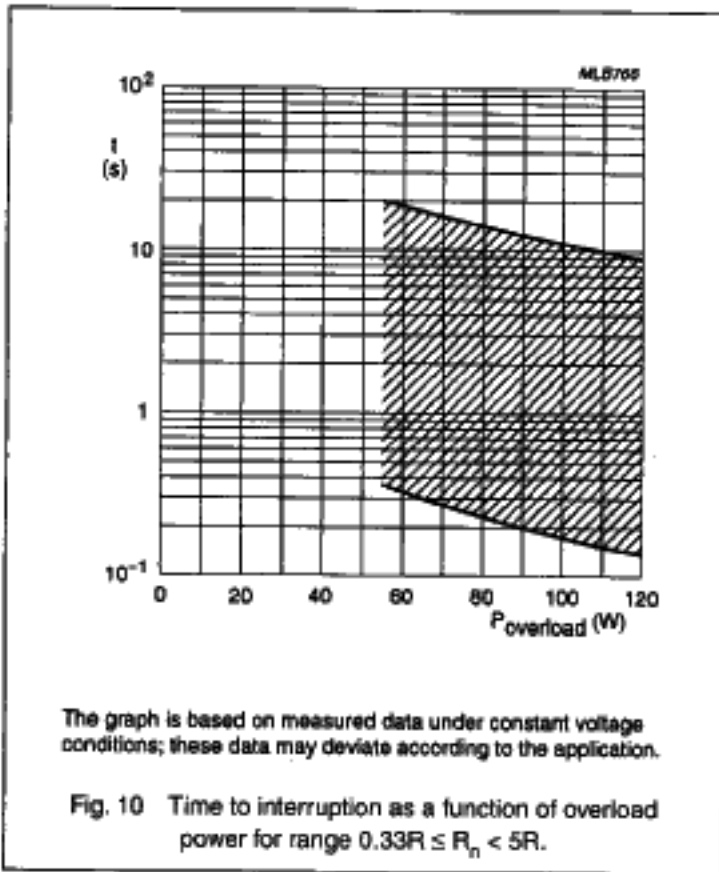

Fig. 9 Pulse on a regular basis; maximum permissible peak pulse voltage (\hat{V}_{max}) as a function of pulse duration (t_i).

Power Metal Film Resistor
2 Watt
1% & 5%

5083NW Series
(2306 198.....)



Power Metal Film Resistor
2 Watt
1% & 5%

5083NW Series
(2306 198.....)

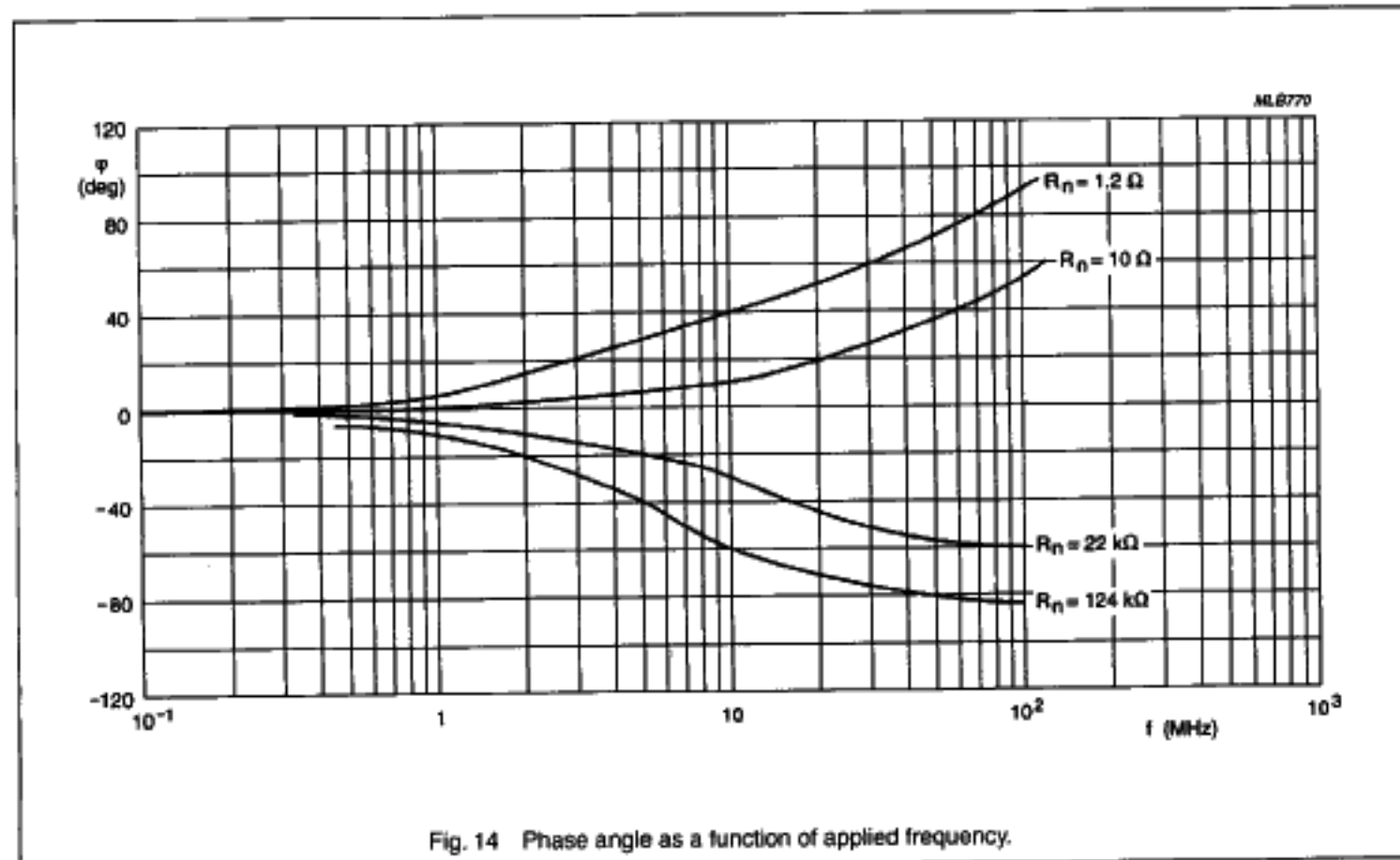
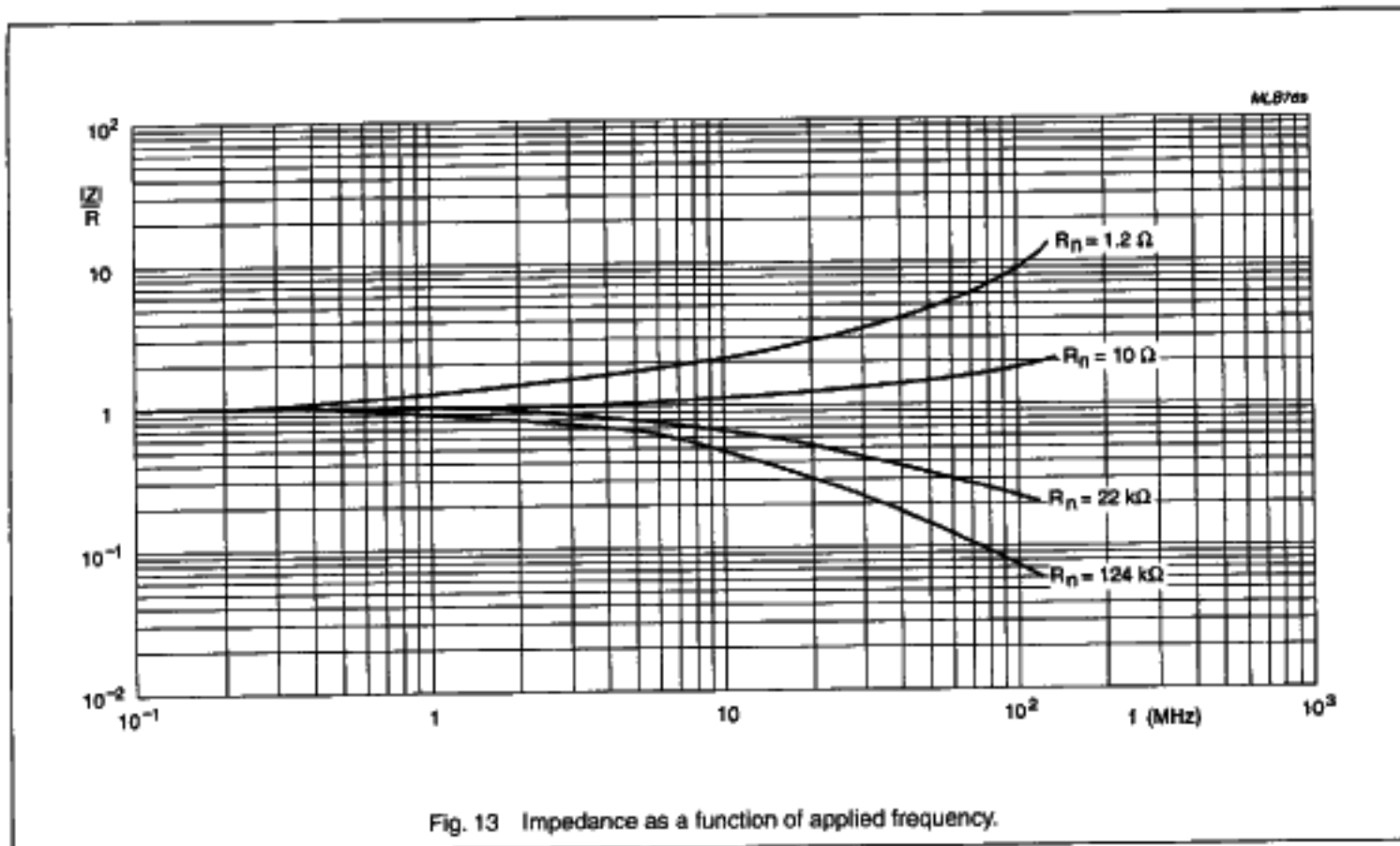

Power Metal Film Resistor
2 Watt
1% & 5%

5083NW Series
(2306 198.....)

ORDERING INFORMATION

North American Part Number

Table II North American Part Number by Tolerance and Range

Resistance Range	Tol. ±%	Series	Part Number 5000 Reel
10 Ω to 1MΩ	1	E24/E96	5083NW.....F
0.33 Ω to 1 MΩ	5	E24	5083NW.....J

The PR02 Series is also available in FeCu Leads and in ammo packaging. Contact the factory for Part Number Descriptions.

The "....." in the part number represents the value of the resistor. The format of the value is composed of five digits. Place the significant figures, separated by a "R", "K", or "M" as the decimal place, and finish out the remainder of the five digits with "0's" if required.

Examples:

$$0.33 \Omega = 0R330$$

$$1,500,000 \Omega = 1M500$$

$$332,000 \Omega = 332K0$$

$$49.9 \Omega = 49R90$$

Power Metal Film Resistor
2 Watt
1% & 5%

5083NW Series
(2306 198.....)

International Part Number

Table III The resistor part numbers start with 2322 194. Subsequent digits indicate packaging and resistance as listed in this table and Table IV.

Resistance Range	Tol. $\pm\%$	Lead Type	Series		
				5000 Reel	1000 Ammo
10 Ω to 1M Ω	1	Cu	E24/96	On Request	On Request
0.33 Ω to 0.91 Ω	5	Cu	E24	On Request	On Request
1 Ω to 1 M Ω	5	Cu	E24	2306 198 23...	On Request
1 Ω to 1 M Ω	5	FeCu	E24	On Request	On Request

Table IV To complete the part number, insert the first two digits (for 5% parts) of the resistance value in ohms followed by:

Nominal Resistance Value	Last Digit of Part Number
1 Ω to 9.1 Ω	8
10 Ω to 91 Ω	9
100 Ω to 910 Ω	1
1 K Ω to 9.1 K Ω	2
10 K Ω to 91 K Ω	3
100 K Ω to 910 K Ω	4
1 M Ω	5

Examples:

$\pm 5\%$

10 Ω = 109
 2,200 Ω = 222
 330,000 Ω = 334

510 Ω = 511
 91,000 Ω = 913
 1,000,000 Ω = 105

Power Metal Film Resistor
2 Watt
1% & 5%

5083NW Series
(2306 198.....)

PACKAGING

The 5083NW Series is available in 5000 piece tape and reel as well as 1000 piece ammo.

Table V Taping Dimensions, 5000 Reel and 1000 Ammopack
 Values in inches (mm)

TYPE	a	A	B ₁ - B ₂ max.	S	T per 10 spacings
5083NW	.236 ± .020 (6 ± 0.5)	2.067 ± .059/-0 (52.5 ± 1.5/-0)	±0.047 (± 1.2)	.200 (5)	0.039 (1)

Table VI Reel Dimension, 5000 Reel
 Values in inches (mm)

TYPE	Q	V
5083NW	14.00 (356)	2.76 (70)

Table VII Dimensions of Ammopack Box
 Values in inches (mm)

TYPE	M	N	P
5083NW	3.82 (97)	2.32 (59)	10.3 (262)