

Dual Enhancement Mode Field Effect Transistor (N and P Channel)

FEATURES

- 40V, 6.1A, $R_{DS(ON)} = 32m\Omega$ @ $V_{GS} = 10V$.
 $R_{DS(ON)} = 46m\Omega$ @ $V_{GS} = 4.5V$.
- -40V, -4.3A, $R_{DS(ON)} = 66m\Omega$ @ $V_{GS} = -10V$.
 $R_{DS(ON)} = 105m\Omega$ @ $V_{GS} = -4.5V$.
- Super high dense cell design for extremely low $R_{DS(ON)}$.
- High power and current handling capability.
- Lead free product is acquired.
- Surface mount Package.

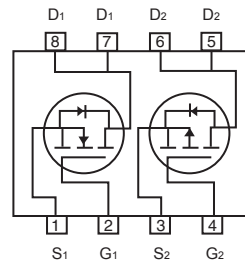
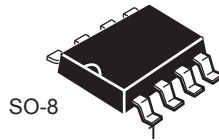

5

ABSOLUTE MAXIMUM RATINGS $T_A = 25^\circ C$ unless otherwise noted

| Parameter | Symbol | N-Channel | P-Channel | Units |
|---------------------------------------|----------------|------------|-----------|------------|
| Drain-Source Voltage | V_{DS} | 40 | -40 | V |
| Gate-Source Voltage | V_{GS} | ± 20 | ± 20 | V |
| Drain Current-Continuous | I_D | 6.1 | -4.3 | A |
| Drain Current-Pulsed ^a | I_{DM} | 24 | -17 | A |
| Maximum Power Dissipation | P_D | 2.0 | | W |
| Operating and Store Temperature Range | T_J, T_{stg} | -55 to 150 | | $^\circ C$ |

Thermal Characteristics

| Parameter | Symbol | Limit | Units |
|--|-----------------|-------|--------------|
| Thermal Resistance, Junction-to-Ambient ^b | $R_{\theta JA}$ | 62.5 | $^\circ C/W$ |



CEM4279

N-Channel Electrical Characteristics $T_A = 25^\circ\text{C}$ unless otherwise noted

| Parameter | Symbol | Test Condition | Min | Typ | Max | Units |
|--|--------------|---|-----|------|------|-----------|
| Off Characteristics | | | | | | |
| Drain-Source Breakdown Voltage | BV_{DSS} | $V_{GS} = 0V, I_D = 250\mu A$ | 40 | | | V |
| Zero Gate Voltage Drain Current | I_{DSS} | $V_{DS} = 40V, V_{GS} = 0V$ | | | 1 | μA |
| Gate Body Leakage Current, Forward | I_{GSSF} | $V_{GS} = 20V, V_{DS} = 0V$ | | | 100 | nA |
| Gate Body Leakage Current, Reverse | I_{GSSR} | $V_{GS} = -20V, V_{DS} = 0V$ | | | -100 | nA |
| On Characteristics^c | | | | | | |
| Gate Threshold Voltage | $V_{GS(th)}$ | $V_{GS} = V_{DS}, I_D = 250\mu A$ | 1 | | 3 | V |
| Static Drain-Source On-Resistance | $R_{DS(on)}$ | $V_{GS} = 10V, I_D = 6.1A$ | | 25 | 32 | $m\Omega$ |
| | | $V_{GS} = 4.5V, I_D = 4.9A$ | | 35 | 46 | $m\Omega$ |
| Dynamic Characteristics^d | | | | | | |
| Forward Transconductance | g_{FS} | $V_{DS} = 5V, I_D = 6.1A$ | | 3 | | S |
| Input Capacitance | C_{iss} | $V_{DS} = 20V, V_{GS} = 0V, f = 1.0\text{ MHz}$ | | 1050 | | pF |
| Output Capacitance | C_{oss} | | | 155 | | pF |
| Reverse Transfer Capacitance | C_{rss} | | | 95 | | pF |
| Switching Characteristics^d | | | | | | |
| Turn-On Delay Time | $t_{d(on)}$ | $V_{DD} = 20V, I_D = 6.1A, V_{GS} = 10V, R_{GEN} = 3\Omega$ | | 14 | 30 | ns |
| Turn-On Rise Time | t_r | | | 10 | 20 | ns |
| Turn-Off Delay Time | $t_{d(off)}$ | | | 17 | 35 | ns |
| Turn-Off Fall Time | t_f | | | 18 | 35 | ns |
| Total Gate Charge | Q_g | $V_{DS} = 20V, I_D = 6.1A, V_{GS} = 4.5V$ | | 10.1 | 13 | nC |
| Gate-Source Charge | Q_{gs} | | | 3.5 | | nC |
| Gate-Drain Charge | Q_{gd} | | | 4.0 | | nC |
| Drain-Source Diode Characteristics and Maximum Ratings | | | | | | |
| Drain-Source Diode Forward Current ^b | I_S | | | | 6.1 | A |
| Drain-Source Diode Forward Voltage ^c | V_{SD} | $V_{GS} = 0V, I_S = 1.0A$ | | | 1.0 | V |
| Notes : a.Repetitive Rating : Pulse width limited by maximum junction temperature. b.Surface Mounted on FR4 Board, $t \leq 10$ sec. c.Pulse Test : Pulse Width $\leq 300\mu s$, Duty Cycle $\leq 2\%$. d.Guaranteed by design, not subject to production testing. | | | | | | |



P-Channel Electrical Characteristics $T_A = 25\text{ C}$ unless otherwise noted

5

| Parameter | Symbol | Test Condition | Min | Typ | Max | Units |
|--|--------------|--|-----|-----|------|-----------|
| Off Characteristics | | | | | | |
| Drain-Source Breakdown Voltage | BV_{DSS} | $V_{GS} = 0V, I_D = -250\mu A$ | -40 | | | V |
| Zero Gate Voltage Drain Current | I_{DSS} | $V_{DS} = -40V, V_{GS} = 0V$ | | | -1 | μA |
| Gate Body Leakage Current, Forward | I_{GSSF} | $V_{GS} = 20V, V_{DS} = 0V$ | | | 100 | nA |
| Gate Body Leakage Current, Reverse | I_{GSSR} | $V_{GS} = -20V, V_{DS} = 0V$ | | | -100 | nA |
| On Characteristics ^c | | | | | | |
| Gate Threshold Voltage | $V_{GS(th)}$ | $V_{GS} = V_{DS}, I_D = -250\mu A$ | -1 | | -3 | V |
| Static Drain-Source On-Resistance | $R_{DS(on)}$ | $V_{GS} = -10V, I_D = -4.3A$ | | 55 | 66 | $m\Omega$ |
| | | $V_{GS} = -4.5V, I_D = -3.7A$ | | 85 | 105 | $m\Omega$ |
| Dynamic Characteristics ^d | | | | | | |
| Forward Transconductance | g_{FS} | $V_{DS} = -5V, I_D = -4.3A$ | | 7 | | S |
| Input Capacitance | C_{iss} | $V_{DS} = -20V, V_{GS} = 0V, f = 1.0\text{ MHz}$ | | 705 | | pF |
| Output Capacitance | C_{oss} | | | 125 | | pF |
| Reverse Transfer Capacitance | C_{rss} | | | 75 | | pF |
| Switching Characteristics ^d | | | | | | |
| Turn-On Delay Time | $t_{d(on)}$ | $V_{DD} = -15V, I_D = -1A, V_{GS} = -10V, R_{GEN} = 6\Omega$ | | 13 | 26 | ns |
| Turn-On Rise Time | t_r | | | 3 | 6 | ns |
| Turn-Off Delay Time | $t_{d(off)}$ | | | 31 | 62 | ns |
| Turn-Off Fall Time | t_f | | | 5 | 10 | ns |
| Total Gate Charge | Q_g | $V_{DS} = -20V, I_D = -4.3A, V_{GS} = -4.5V$ | | 5.6 | 7.4 | nC |
| Gate-Source Charge | Q_{gs} | | | 2.1 | | nC |
| Gate-Drain Charge | Q_{gd} | | | 2.3 | | nC |
| Drain-Source Diode Characteristics and Maximum Ratings | | | | | | |
| Drain-Source Diode Forward Current ^b | I_S | | | | -4.3 | A |
| Drain-Source Diode Forward Voltage ^c | V_{SD} | $V_{GS} = 0V, I_S = -1.3A$ | | | -1.2 | V |
| Notes : <input type="checkbox"/> a.Repetitive Rating : Pulse width limited by maximum junction temperature. <input type="checkbox"/> b.Surface Mounted on FR4 Board, $t \leq 10\text{ sec.}$ <input type="checkbox"/> c.Pulse Test : Pulse Width $\leq 300\mu s$, Duty Cycle $\leq 2\%$. <input type="checkbox"/> d.Guaranteed by design, not subject to production testing. <input type="checkbox"/> <input type="checkbox"/> | | | | | | |



CEM4279

N-CHANNEL

5

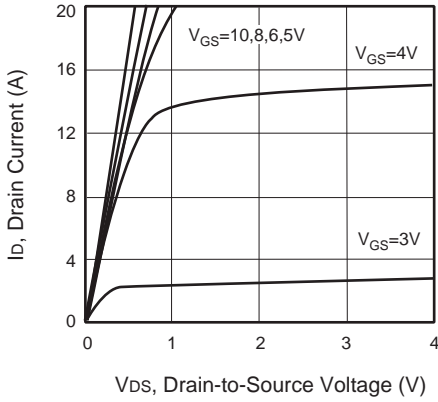

Figure 1. Output Characteristics

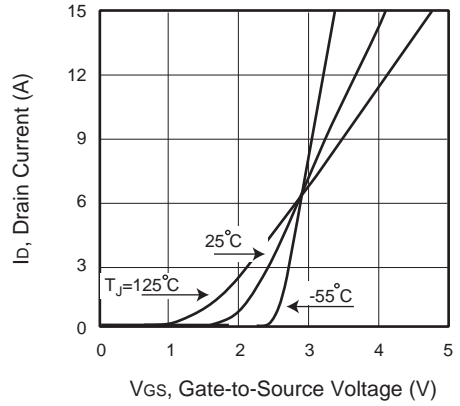

Figure 2. Transfer Characteristics

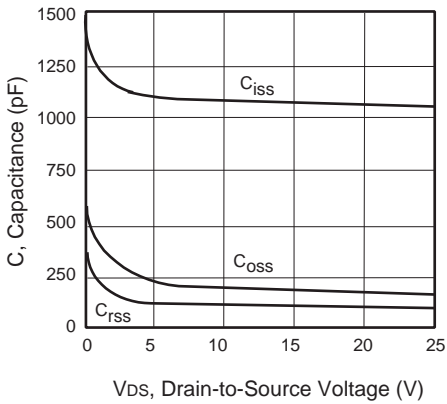

Figure 3. Capacitance

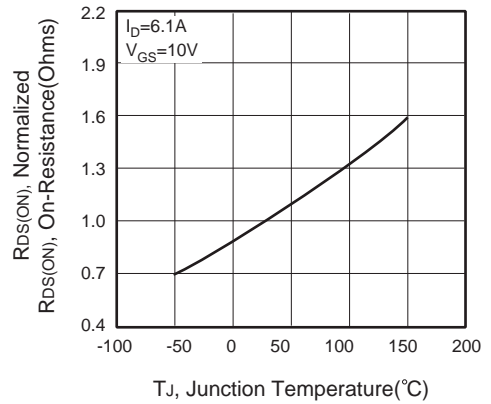

Figure 4. On-Resistance Variation with Temperature

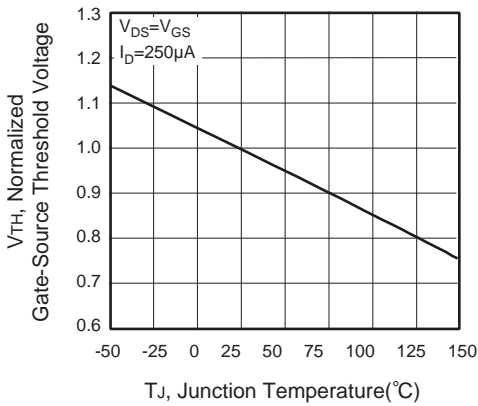

Figure 5. Gate Threshold Variation with Temperature

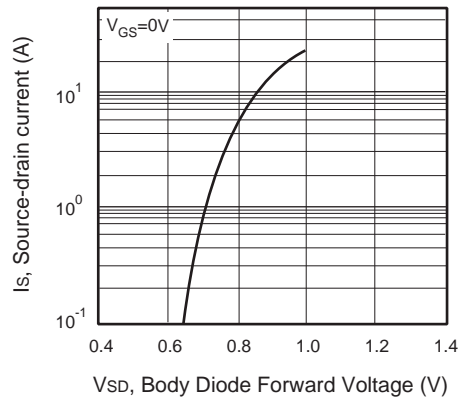

Figure 6. Body Diode Forward Voltage Variation with Source Current



CEM4279

P-CHANNEL

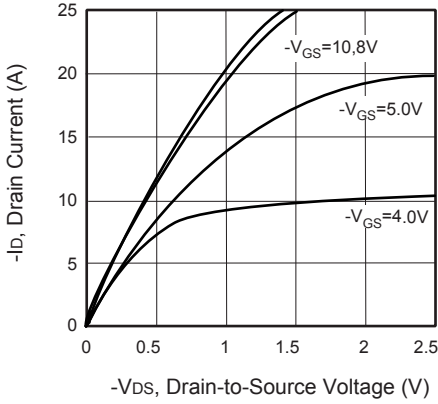

Figure 1. Output Characteristics

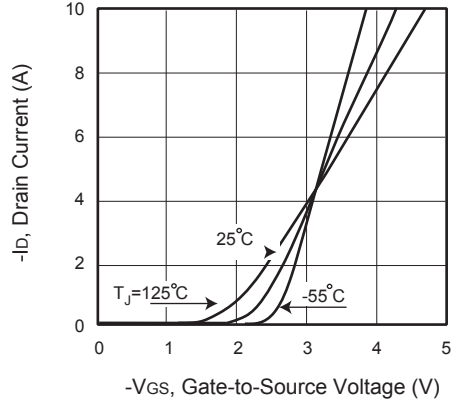

Figure 2. Transfer Characteristics

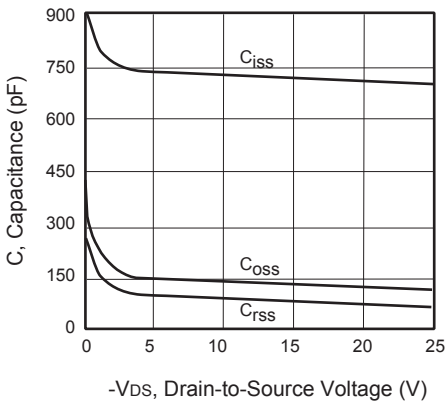

Figure 3. Capacitance

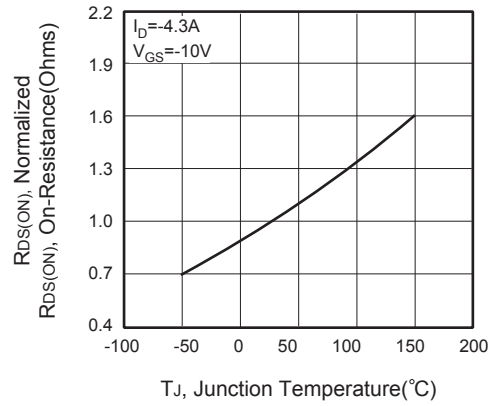

Figure 4. On-Resistance Variation with Temperature

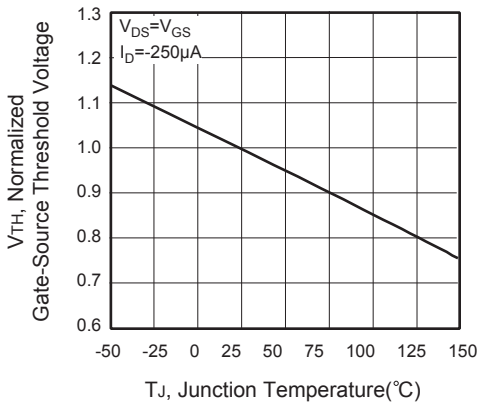

Figure 5. Gate Threshold Variation with Temperature

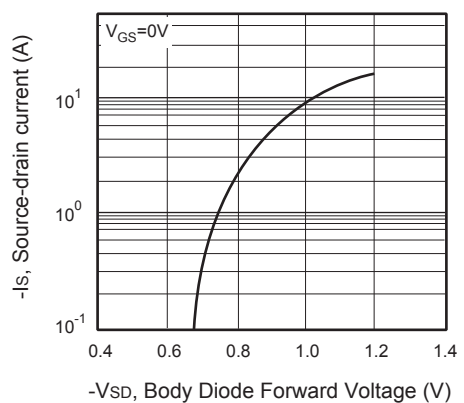

Figure 6. Body Diode Forward Voltage Variation with Source Current



N-CHANNEL

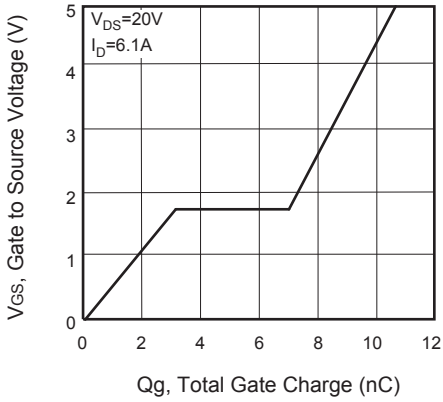

Figure 13. Gate Charge

P-CHANNEL

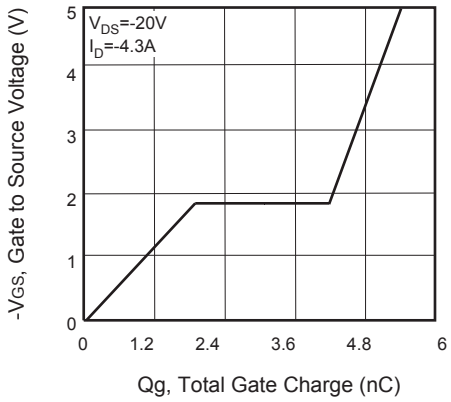

Figure 15. Gate Charge

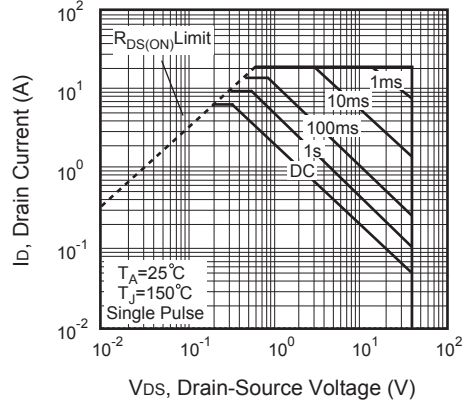

Figure 14. Maximum Safe Operating Area

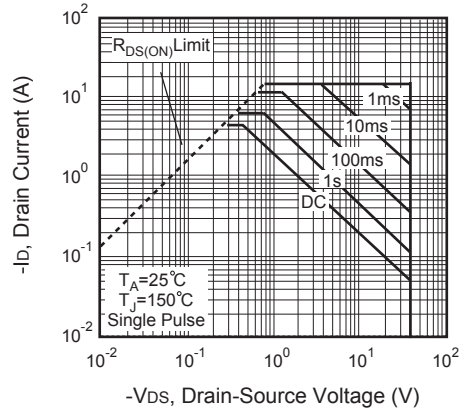

Figure 16. Maximum Safe Operating Area

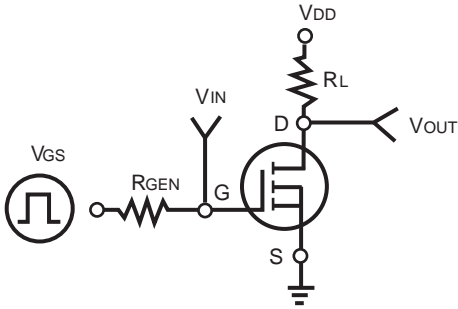

Figure 17. Switching Test Circuit

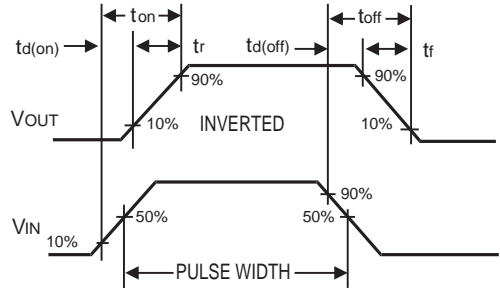

Figure 18. Switching Waveforms

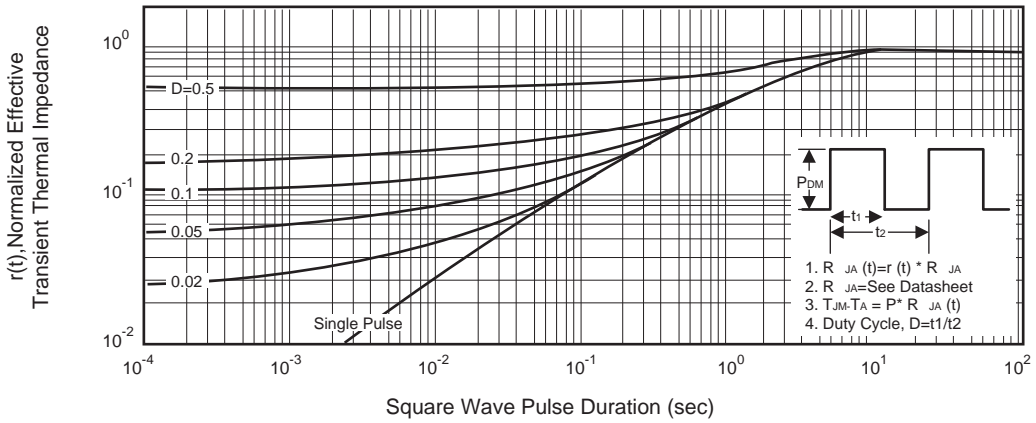

Figure 19. Normalized Thermal Transient Impedance Curve