

NPN EPITAXIAL PLANAR TYPE

TEST CIRCUIT (f=520MHz)

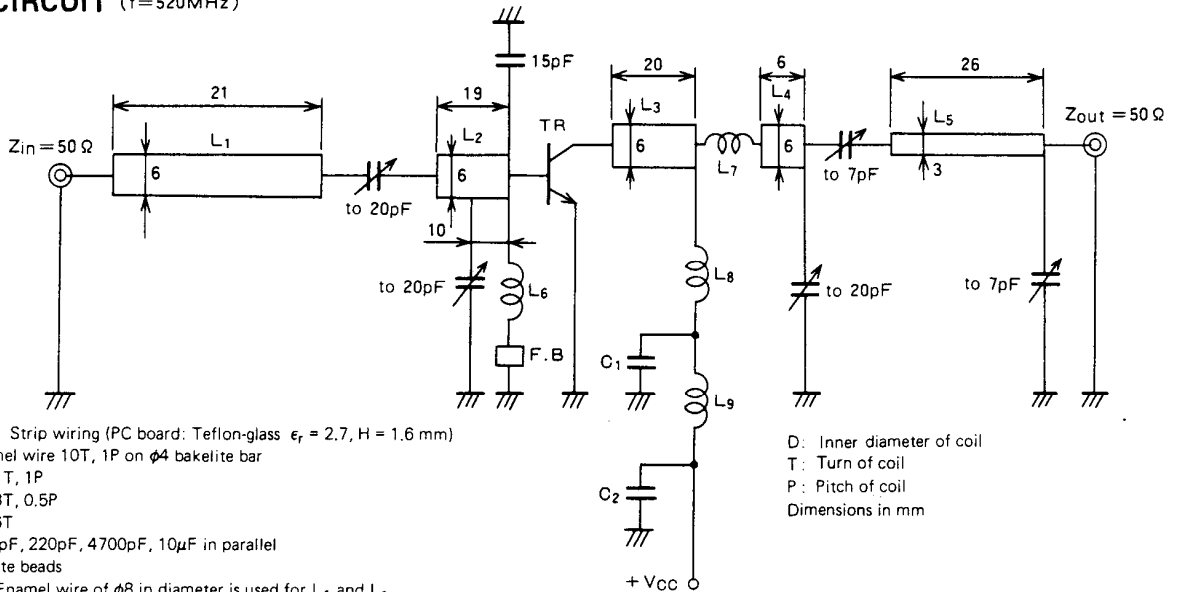

TYPICAL PERFORMANCE DATA

COLLECTOR OUTPUT CAPACITANCE VS. COLLECTOR TO BASE VOLTAGE

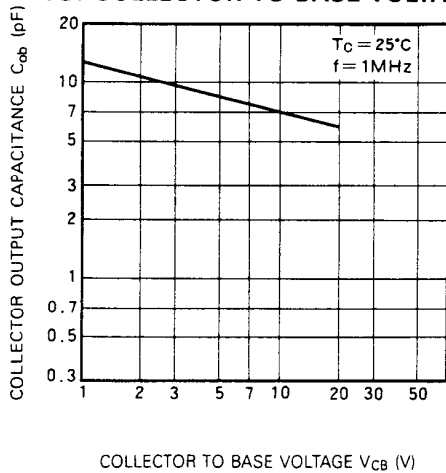

COLLECTOR DISSIPATION VS. CASE TEMPERATURE

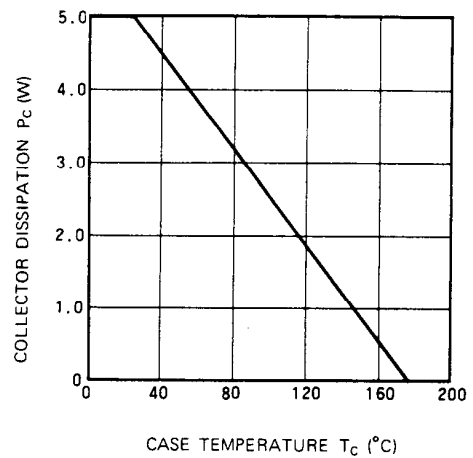

NPN EPITAXIAL PLANAR TYPE

OUTPUT POWER, COLLECTOR EFFICIENCY VS. INPUT POWER

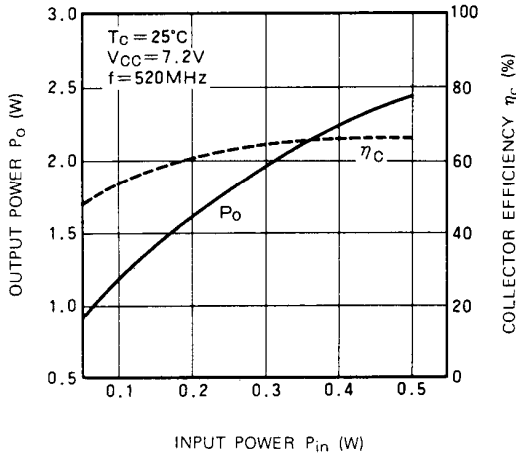

OUTPUT POWER VS. COLLECTOR SUPPLY VOLTAGE VARIATION

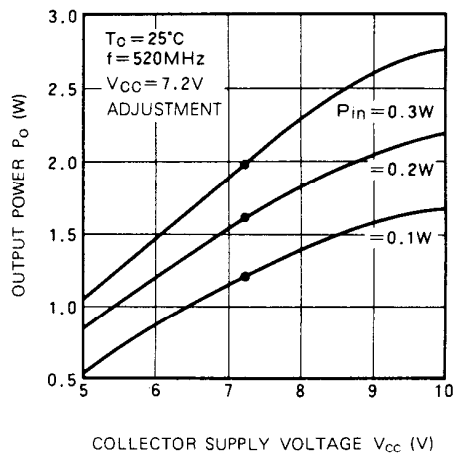

INPUT/OUTPUT IMPEDANCE VS. FREQUENCY

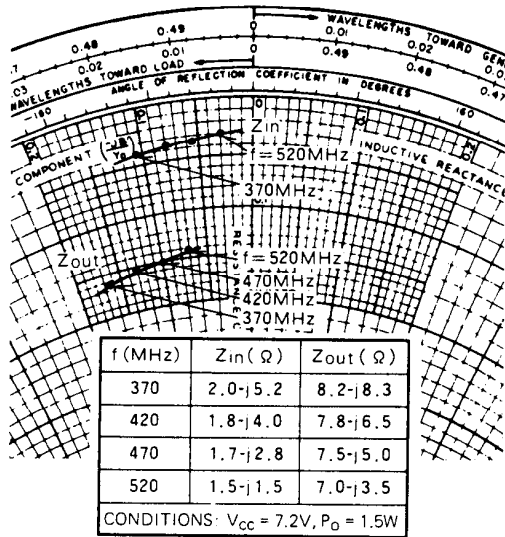

OUTPUT POWER VS. FREQUENCY

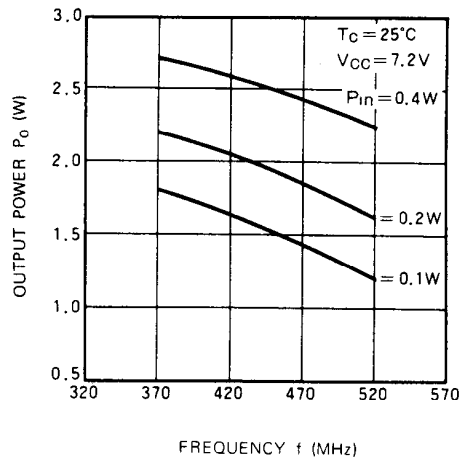

PRECAUTIONS FOR MOUNTING HIGH-FREQUENCY HIGH-OUTPUT TRANSISTOR FOR MOBILE RADIO EQUIPMENT

When mounting high-frequency, high-output transistors for mobile radio equipment (flange screw fastening part cut package), care should be taken to the following points.

1. When mounting the device to the heat sink, silicon compound should be applied to the heat sink and device heat radiating fin and apply the device to the heat sink using a proper fastening tool.
2. If the device is soldered directly to heat sink, excessive thermal stress will result in deteriorating the reliability. Do not use this mounting method.

3. Care should be taken, if the device is applied to the heat sink, the force of soldering the leads to the printed circuit board results in continual mechanical stress, deteriorating the reliability and performance of the system.
4. Refer to Mitsubishi's DATABOOK or manuals for transistors, small-signal diodes and integrated circuit modules for mounting and handling of the device.