

FUJI POWER MOSFET Super FAP-G Series

N-CHANNEL SILICON POWER MOSFET

Features

- High speed switching
- Low on-resistance
- No secondary breakdown
- Low driving power
- Avalanche-proof

Applications

- Switching regulators
- UPS (Uninterruptible Power Supply)
- DC-DC converters

Maximum ratings and characteristic Absolute maximum ratings

(T_c=25°C unless otherwise specified)

| Item | Symbol | Ratings | Unit |
|---|-------------------------|----------------------|-------|
| Drain-source voltage | V _{DS} | 100 | V |
| | V _{DSX} *5 | 70 | V |
| Continuous drain current | I _D | ±29 | A |
| Pulsed drain current | I _{D(puls)} | ±116 | A |
| Gate-source voltage | V _{GS} | ±30 | V |
| Non-repetitive Avalanche current | I _{AS} *2 | 29 | A |
| Maximum Avalanche Energy | E _{AS} *1 | 155.8 | mJ |
| Maximum Drain-Source dV/dt | dV _{DS} /dt *4 | 20 | kV/μs |
| Peak Diode Recovery dV/dt | dV/dt *3 | 5 | kV/μs |
| Max. power dissipation | P _D | T _a =25°C | 1.67 |
| | | T _c =25°C | 105 |
| Operating and storage temperature range | T _{ch} | +150 | °C |
| | T _{stg} | -55 to +150 | °C |

*1 L=222μH, V_{CC}=48V, T_{ch}=25°C, See to Avalanche Energy Graph *2 T_{ch} ≤ 150°C

*3 I_F ≤ -I_D, -di/dt=50A/μs, V_{CC} ≤ BV_{DSS}, T_{ch} ≤ 150°C *4 V_{DS} ≤ 100V *5 V_{GS}=-30V

Electrical characteristics (T_c =25°C unless otherwise specified)

| Item | Symbol | Test Conditions | Min. | Typ. | Max. | Units |
|----------------------------------|----------------------|---|------------------------|------|------|-------|
| Drain-source breakdown voltage | V _{(BR)DSS} | I _D = 250μA V _{GS} =0V | 100 | | | V |
| Gate threshold voltage | V _{GS(th)} | I _D = 250μA V _{DS} =V _{GS} | 3.0 | | 5.0 | V |
| Zero gate voltage drain current | I _{DSS} | V _{DS} =100V V _{GS} =0V V _{DS} =80V V _{GS} =0V | T _{ch} =25°C | | 25 | μA |
| | | | T _{ch} =125°C | | 250 | |
| Gate-source leakage current | I _{GSS} | V _{GS} =±30V V _{DS} =0V | | 10 | 100 | nA |
| Drain-source on-state resistance | R _{DS(on)} | I _D =10A V _{GS} =10V | | 47 | 62 | mΩ |
| Forward transconductance | g _{fs} | I _D =10A V _{DS} =25V | 6 | 12 | | S |
| Input capacitance | C _{iss} | V _{DS} =75V V _{GS} =0V f=1MHz | | 730 | 1095 | pF |
| Output capacitance | C _{oss} | | | 190 | 285 | |
| Reverse transfer capacitance | C _{rss} | | | 12 | 18 | |
| Turn-on time t _{on} | td(on) | V _{CC} =48V I _D =10A V _{GS} =10V | | 12 | 18 | ns |
| | t _r | | | 3.8 | 6 | |
| Turn-off time t _{off} | td(off) | R _{GS} =10 Ω | | 23 | 35 | ns |
| | t _f | | | 8.5 | 13 | |
| Total Gate Charge | Q _G | V _{CC} =50V | | 22 | 33 | nC |
| Gate-Source Charge | Q _{GS} | I _D =20A | | 9 | 13.5 | |
| Gate-Drain Charge | Q _{GD} | V _{GS} =10V | | 6 | 9 | |
| Avalanche capability | I _{AV} | L=222μH T _{ch} =25°C | 29 | | | A |
| Diode forward on-voltage | V _{SD} | I _F =20A V _{GS} =0V T _{ch} =25°C | | 1.10 | 1.65 | V |
| Reverse recovery time | t _{rr} | I _F =20A V _{GS} =0V | | 65 | | ns |
| Reverse recovery charge | Q _{rr} | -di/dt=100A/μs T _{ch} =25°C | | 0.17 | | μC |

Thermal characteristics

| Item | Symbol | Test Conditions | Min. | Typ. | Max. | Units |
|--------------------|-----------------------|--------------------|------|------|-------|-------|
| Thermal resistance | R _{th(ch-c)} | channel to case | | | 1.191 | °C/W |
| | R _{th(ch-a)} | channel to ambient | | | 75.0 | °C/W |

Outline Drawings (mm)

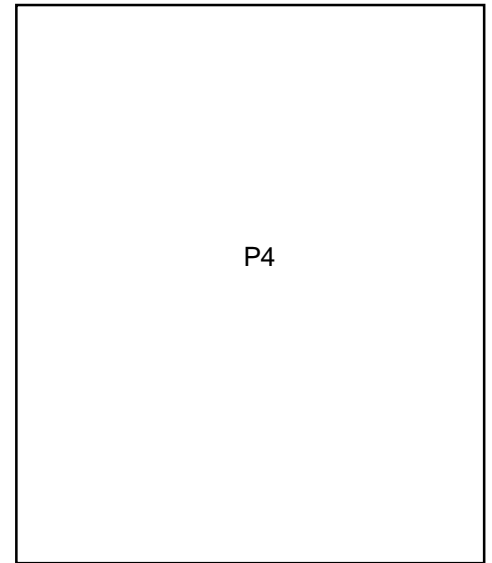

Equivalent circuit schematic

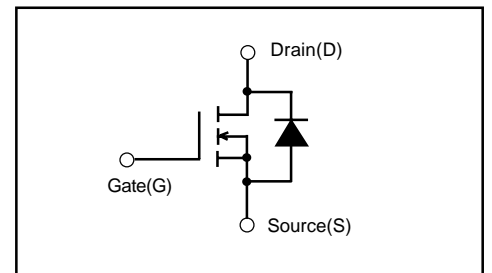

Characteristics

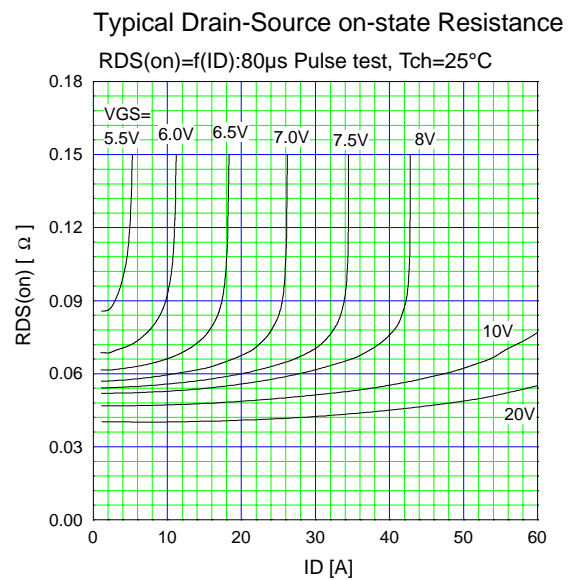
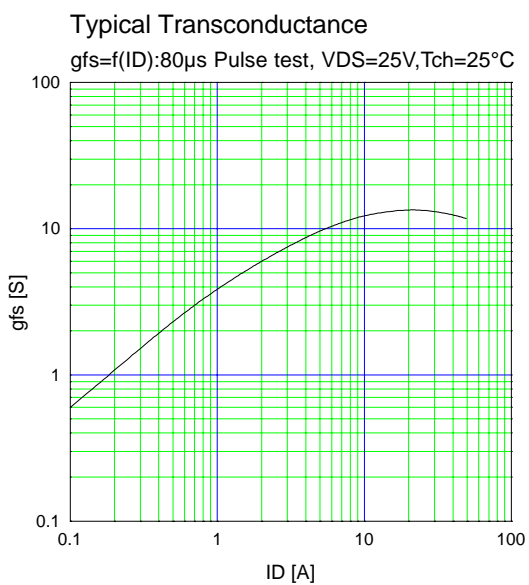
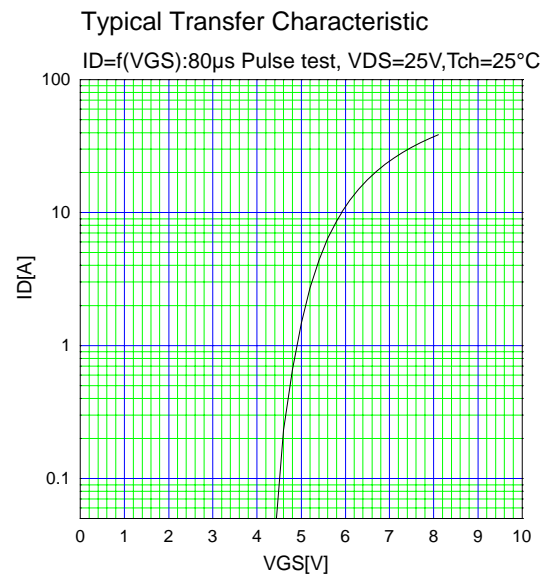
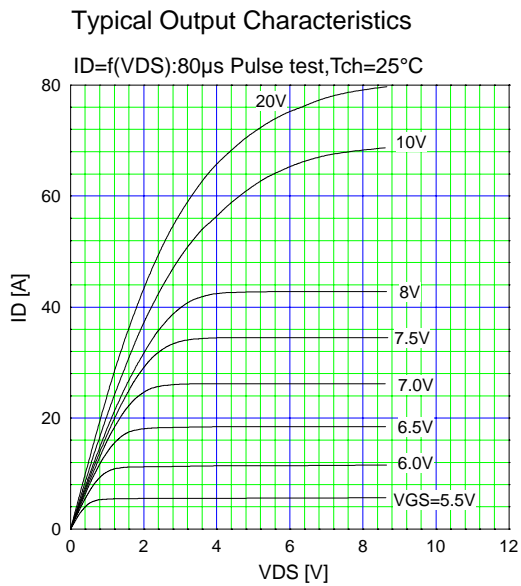
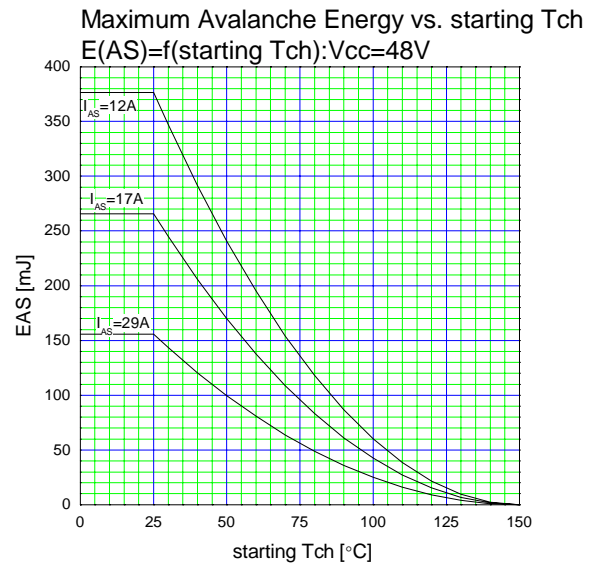
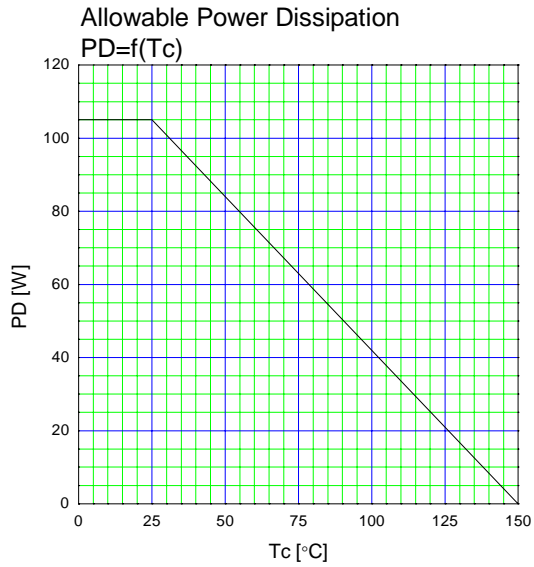

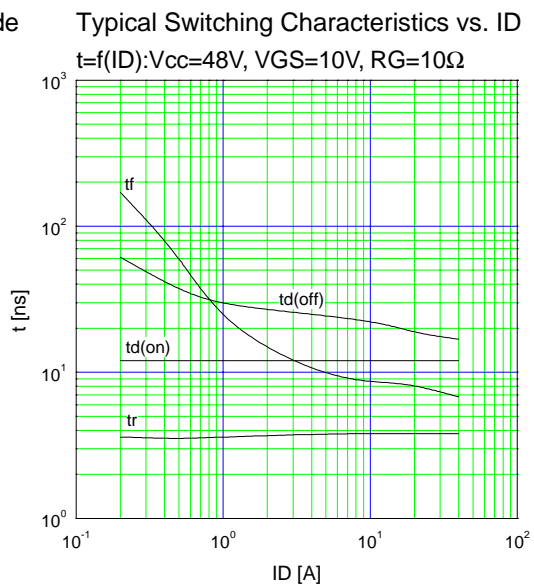
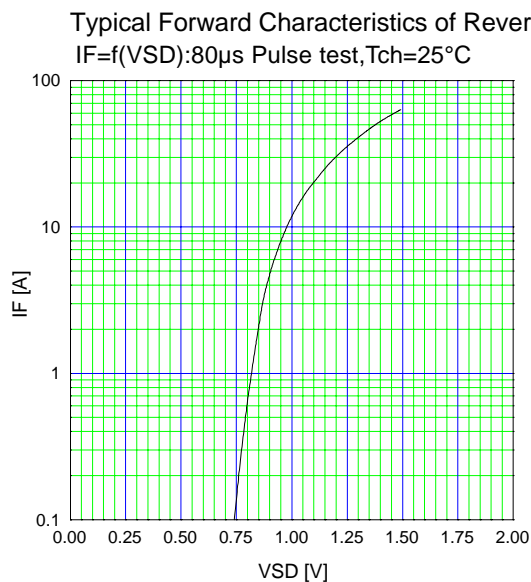
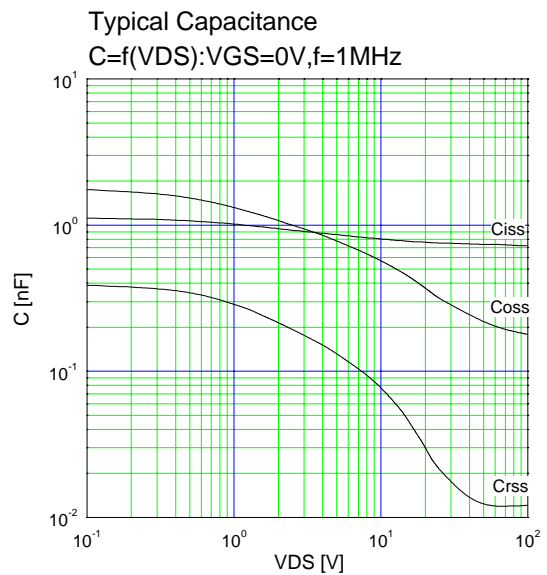
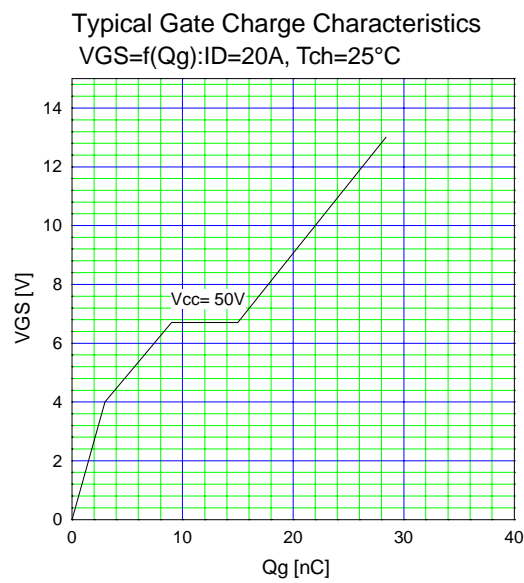
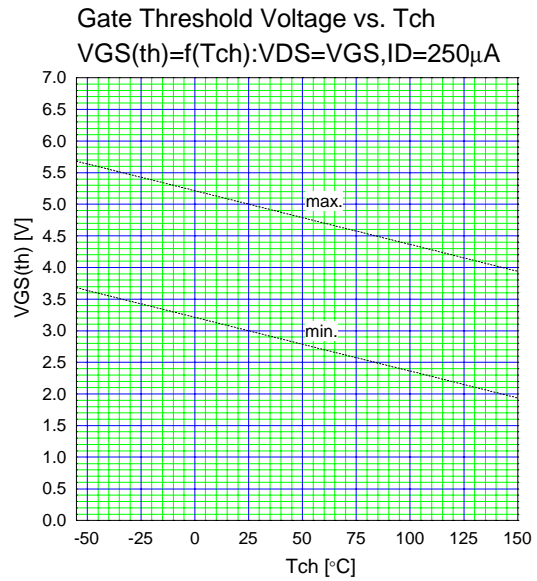
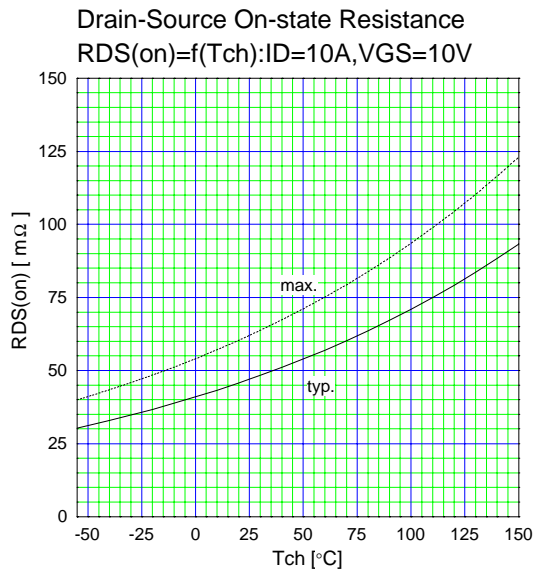

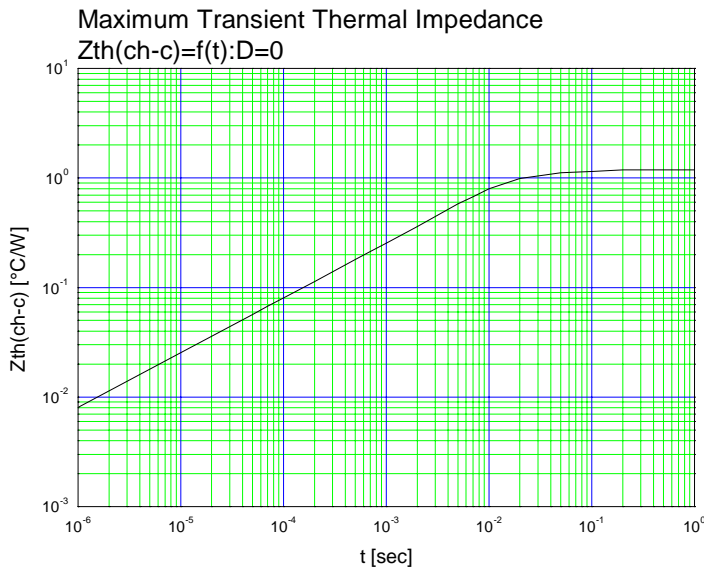
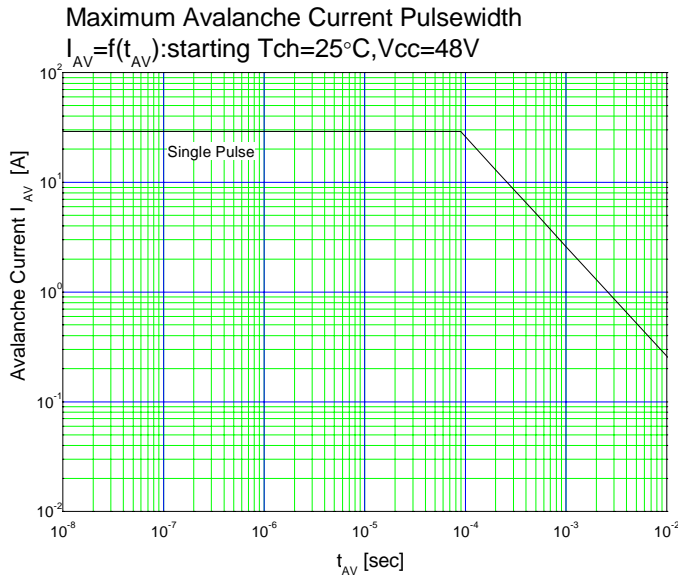

Outline Drawings (mm)

Type(L)

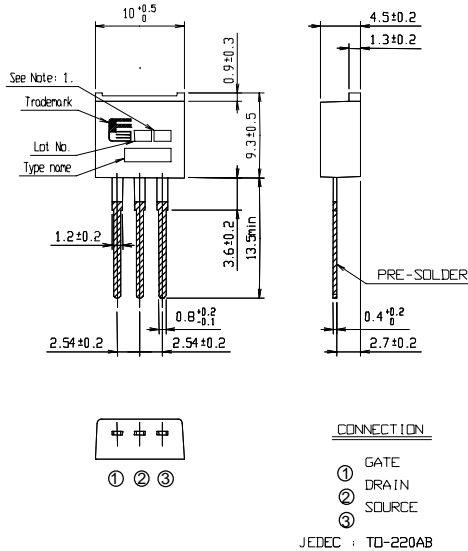

Type(S)

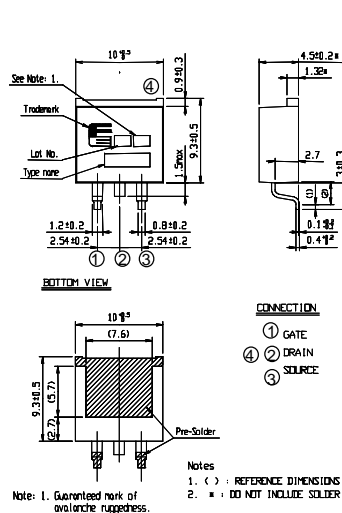

Type(SJ)

