

# DATA SHEET

## **BLV935** UHF power transistor

Product specification

1995 Jun 29

# UHF power transistor

# BLV935

### FEATURES

- Emitter ballasting resistors for an optimum temperature profile
- Gold metallization ensures excellent reliability
- Internal input matching to achieve high power gain and easy design of wideband circuits.

### APPLICATIONS

- Base stations in the 820 to 980 MHz range.

### PINNING - SOT273

PIN	SYMBOL	DESCRIPTION
1	e	emitter
2	e	emitter
3	c	collector
4	b	base
5	e	emitter
6	e	emitter

### DESCRIPTION

NPN silicon planar epitaxial transistor intended for common emitter class-AB operation. The transistor has internal input matching by means of MOS capacitors and is encapsulated in a 6-lead SOT273 flange envelope with a ceramic cap. All leads are isolated from the flange.

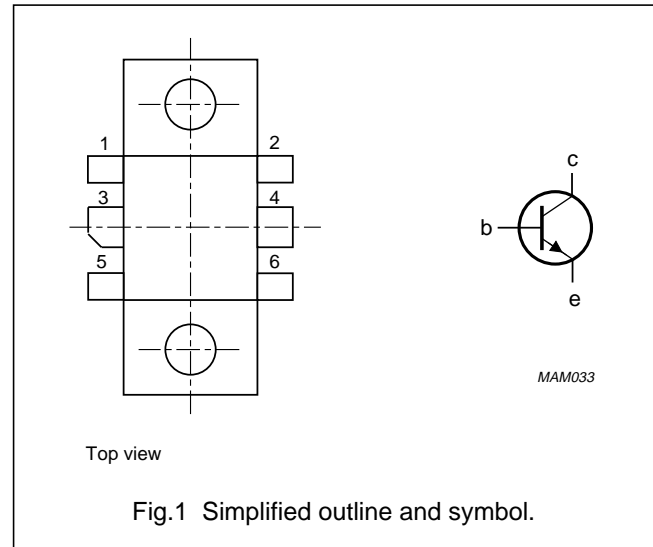

### QUICK REFERENCE DATA

RF performance at  $T_h = 25\text{ }^\circ\text{C}$  in a common emitter test circuit.

MODE OF OPERATION	f (MHz)	$V_{CE}$ (V)	$P_L$ (W)	$G_p$ (dB)	$\eta_c$ (%)
CW, class-AB	960	26	30	$\geq 9$	$\geq 55$

### WARNING

#### Product and environmental safety - toxic materials

This product contains beryllium oxide. The product is entirely safe provided that the BeO disc is not damaged. All persons who handle, use or dispose of this product should be aware of its nature and of the necessary safety precautions. After use, dispose of as chemical or special waste according to the regulations applying at the location of the user. It must never be thrown out with the general or domestic waste.

# UHF power transistor

# BLV935

## LIMITING VALUES

In accordance with the Absolute Maximum Rating System (IEC 134).

SYMBOL	PARAMETER	CONDITIONS	MIN.	MAX.	UNIT
$V_{CBO}$	collector-base voltage	open emitter	–	70	V
$V_{CEO}$	collector-emitter voltage	open base	–	30	V
$V_{EBO}$	emitter-base voltage	open collector	–	3	V
$I_C$	collector current (DC)		–	4	A
$I_{C(AV)}$	average collector current		–	4	A
$P_{tot}$	total power dissipation	up to $T_{mb} = 25\text{ °C}$	–	70	W
$T_{stg}$	storage temperature		–65	+150	°C
$T_j$	operating junction temperature		–	+200	°C

## THERMAL CHARACTERISTICS

SYMBOL	PARAMETER	CONDITIONS	VALUE	UNIT
$R_{th\ j-mb}$	thermal resistance from junction to mounting base	$P_{tot} = 70\text{ W}; T_{mb} = 25\text{ °C}$	2.5	K/W
$R_{th\ mb-h}$	thermal resistance from mounting base to heatsink		0.3	K/W

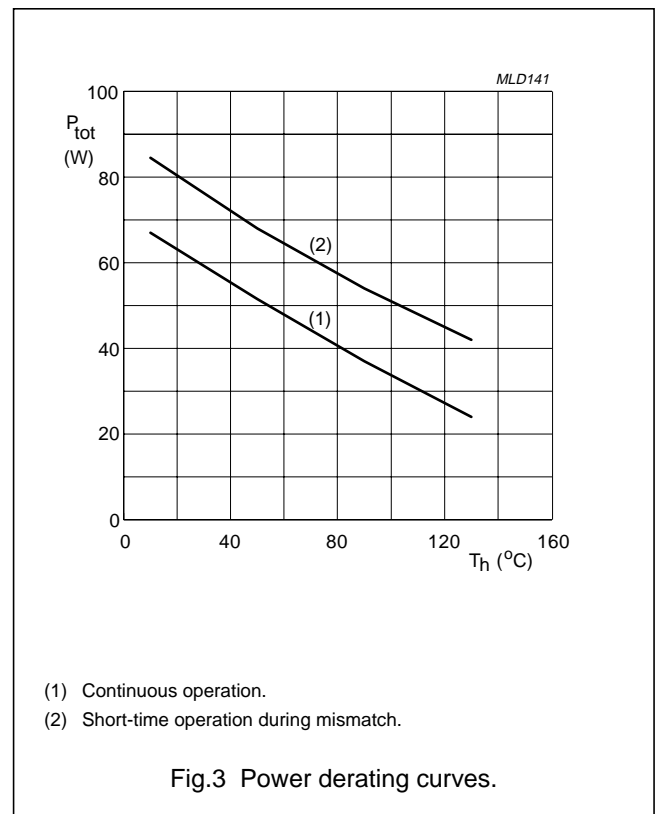
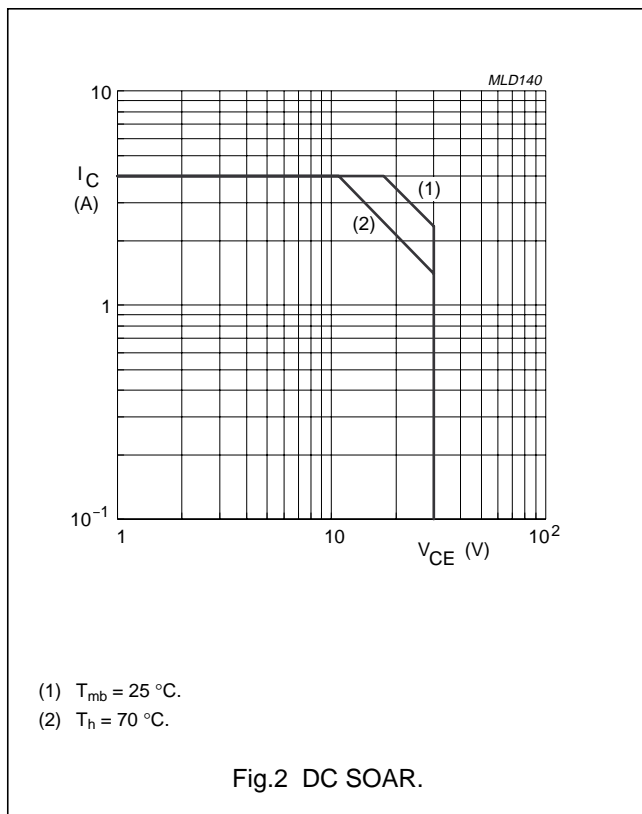

UHF power transistor

BLV935

**CHARACTERISTICS**

$T_j = 25\text{ }^\circ\text{C}$  unless otherwise specified.

SYMBOL	PARAMETER	CONDITIONS	MIN.	TYP.	MAX.	UNIT
$V_{(BR)CBO}$	collector-base breakdown voltage	open emitter; $I_C = 20\text{ mA}$	70	–	–	V
$V_{(BR)CEO}$	collector-emitter breakdown voltage	open base; $I_C = 50\text{ mA}$	30	–	–	V
$V_{(BR)EBO}$	emitter-base breakdown voltage	open collector; $I_E = 1\text{ mA}$	3	–	–	V
$I_{CES}$	collector leakage current	$V_{BE} = 0; V_{CE} = 28\text{ V}$	–	–	2	mA
$h_{FE}$	DC current gain	$V_{CE} = 10\text{ V}; I_C = 1.5\text{ A};$ note 1	30	–	120	
$C_c$	collector capacitance	$V_{CB} = 26\text{ V}; I_E = i_e = 0; f = 1\text{ MHz};$ note 2	–	25	–	pF
$C_{fe}$	feedback capacitance	$V_{CE} = 26\text{ V}; I_C = 0; f = 1\text{ MHz}$	–	17	–	pF

**Notes**

1. Measured under pulsed conditions:  $t_p \leq 500\text{ }\mu\text{s}; \delta \leq 0.01$ .
2.  $C_c$  value is that of the die only; it is not measurable because of internal matching network.

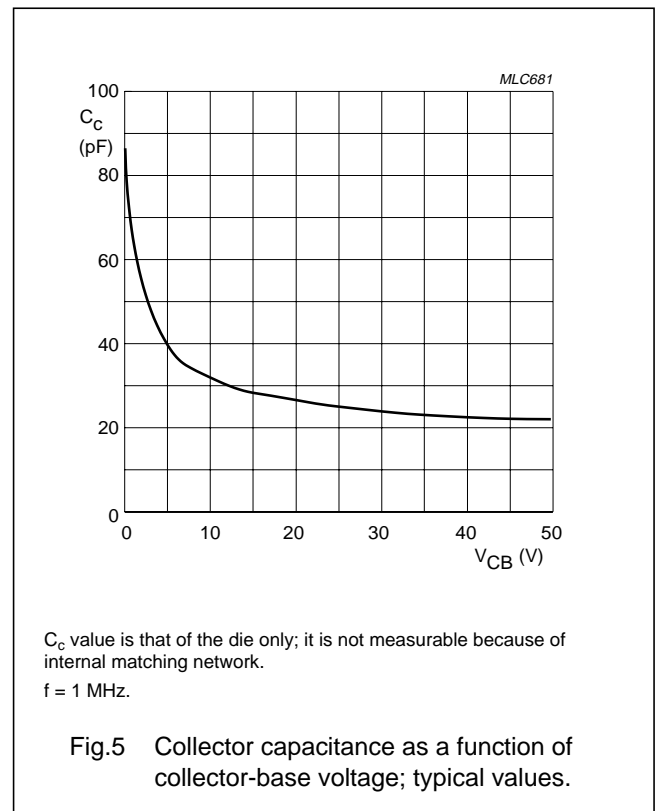
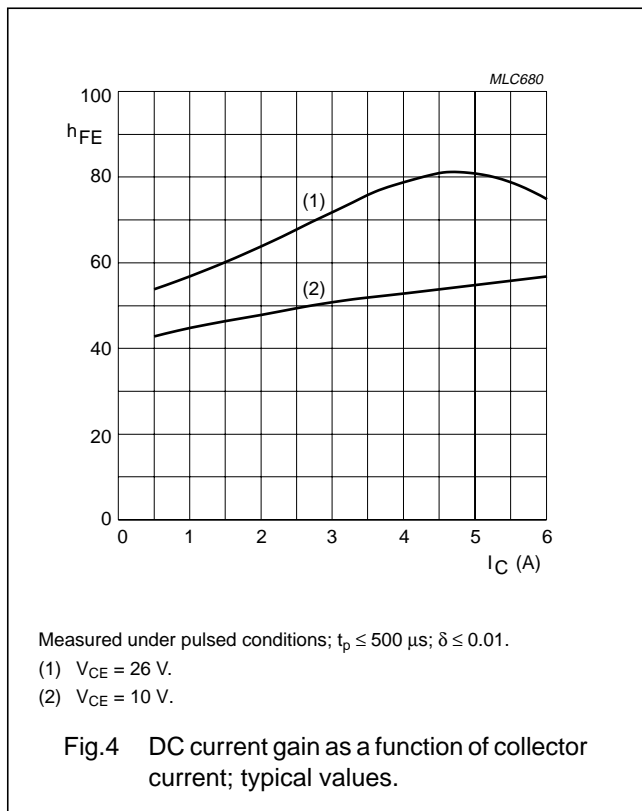

# UHF power transistor

# BLV935

## APPLICATION INFORMATION

RF performance at  $T_h = 25\text{ }^\circ\text{C}$  in a common emitter, class-AB test circuit;  $R_{th\ mb-h} = 0.3\text{ K/W}$ .

MODE OF OPERATION	f (MHz)	V <sub>CE</sub> (V)	I <sub>CQ</sub> (mA)	P <sub>L</sub> (W)	G <sub>p</sub> (dB)	η <sub>c</sub> (%)
CW, class-AB	960	26	100	30	≥9 typ. 10	≥55 typ. 60

### Ruggedness in class-AB operation

The BLV935 is capable of withstanding a load mismatch corresponding to  $V_{SWR} = 5 : 1$  through all phases at rated output power, under the following conditions:  $V_{CE} = 26\text{ V}$ ;  $f = 960\text{ MHz}$ ;  $I_{CQ} = 100\text{ mA}$ ;  $T_h = 25\text{ }^\circ\text{C}$ ;  $R_{th\ mb-h} = 0.3\text{ K/W}$ .

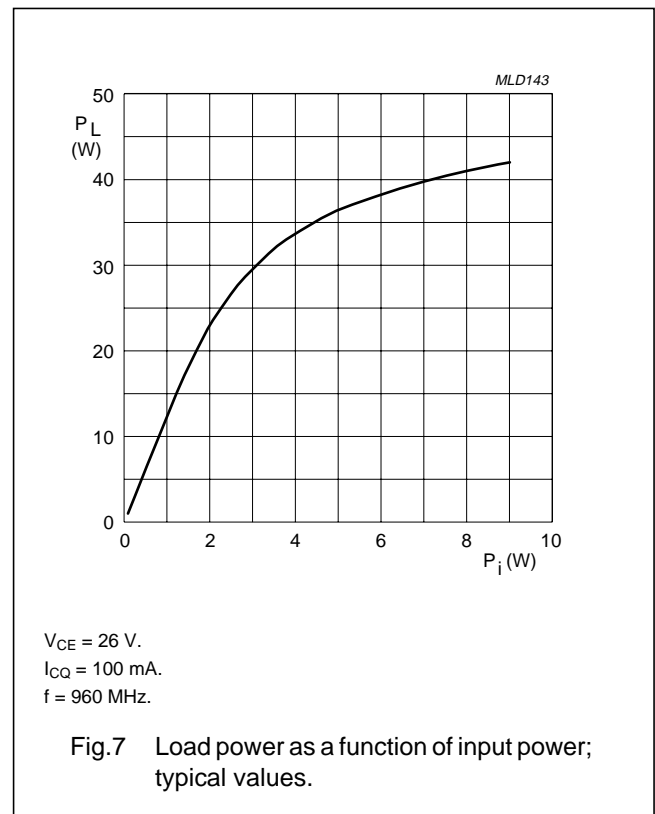
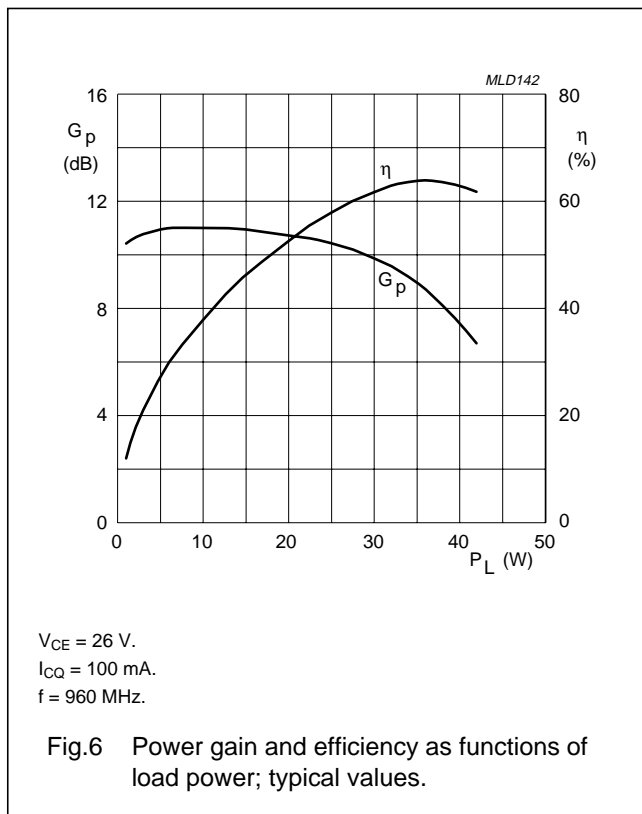

UHF power transistor

BLV935

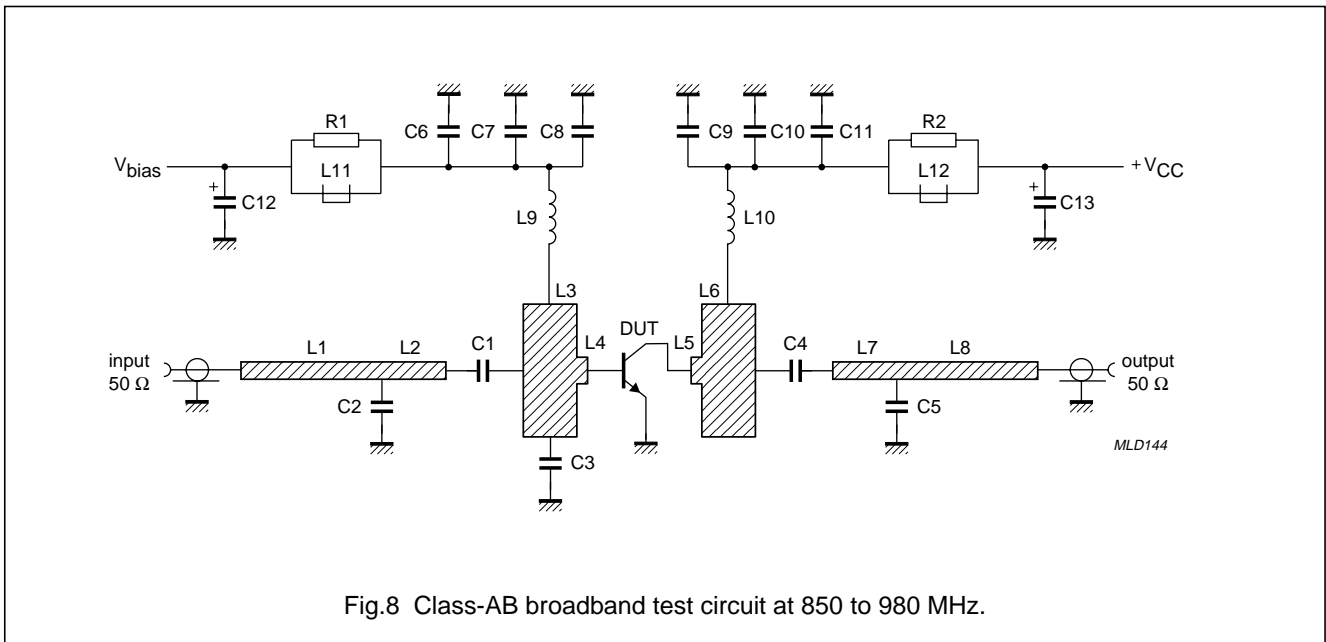

List of components (see Figs 8 and 9)

COMPONENT	DESCRIPTION	VALUE	DIMENSIONS	CATALOGUE No.
C1, C4	multilayer ceramic chip capacitor; note 1	68 pF		
C2	multilayer ceramic chip capacitor; note 1	0.7 pF		
C3	multilayer ceramic chip capacitor; note 1	3.9 pF		
C5	multilayer ceramic chip capacitor; note 1	2 pF		
C6, C11	multilayer ceramic chip capacitor; note 1	1 nF		
C7, C8, C9, C10	multilayer ceramic chip capacitor; note 1	20 pF		
C12, C13	63 V solid aluminium capacitor	10 µF		2222 030 38109
L1, L8	stripline; note 2	50 Ω	41 × 2.4 mm	
L2, L7	stripline; note 2	50 Ω	12 × 2.4 mm	
L3, L6	stripline; note 2	9 Ω	10 × 20 mm	
L4, L5	stripline; note 2	38 Ω	4.5 × 3.5 mm	
L9	microchoke	100 nH		4322 057 01071

## UHF power transistor

BLV935

COMPONENT	DESCRIPTION	VALUE	DIMENSIONS	CATALOGUE No.
L10	4 turns 1 mm enamelled copper wire (close wound)	65 nH	internal diameter: 4 mm length: 4 mm leads: 2 × 5 mm	
L11, L12	grade 3B Ferroxcube wideband RF choke			4312 020 36642
R1, R2	metal film resistor	10 Ω; 0.4 W		2322 151 71009

**Notes**

1. American Technical Ceramics type 100B or capacitor of same quality.
2. The striplines are on double-clad PCB with PTFE fibre-glass dielectric ( $\epsilon_r = 2.2$ ); thickness  $\frac{1}{32}$ ".

UHF power transistor

BLV935

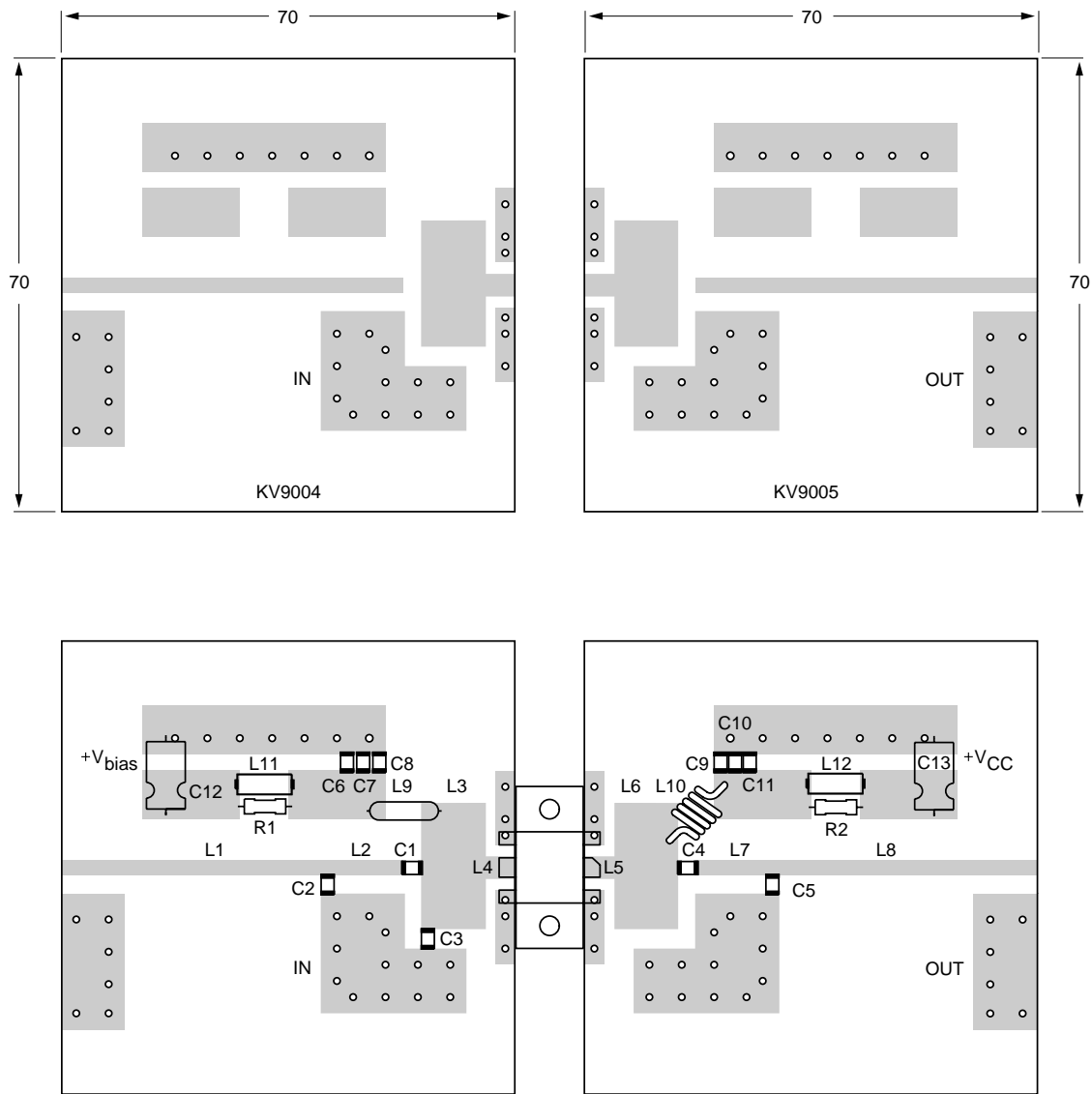

MLD145

Dimensions in mm.

The components are located on one side of the PTFE fibre-glass board, the other side being fully metallized to serve as an earth. Earth connections are made by fixing screws, hollow rivets and copper straps around the board and under the emitters to provide a direct contact between the component side and the ground plane.

Fig.9 Printed circuit board and component layout for class-AB test circuit (850-980 MHz).



UHF power transistor

BLV935

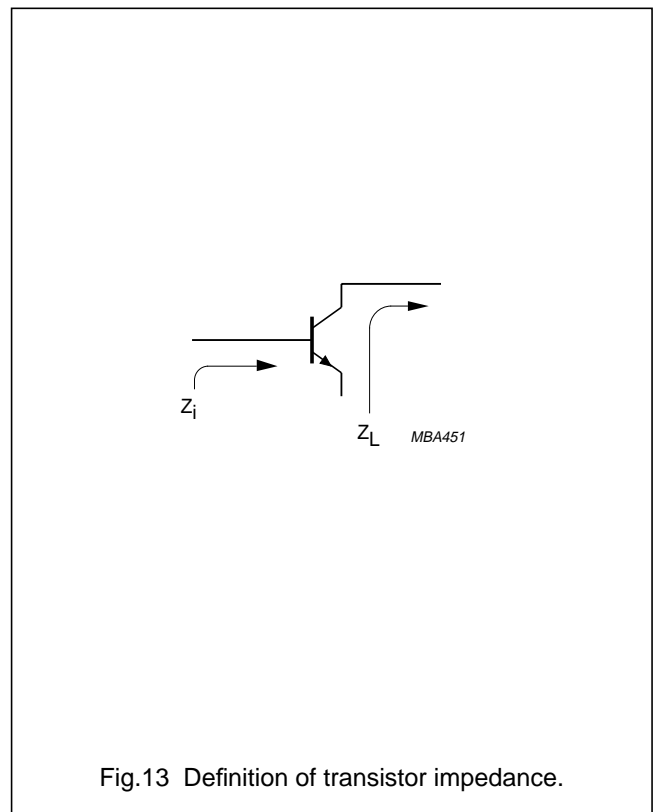
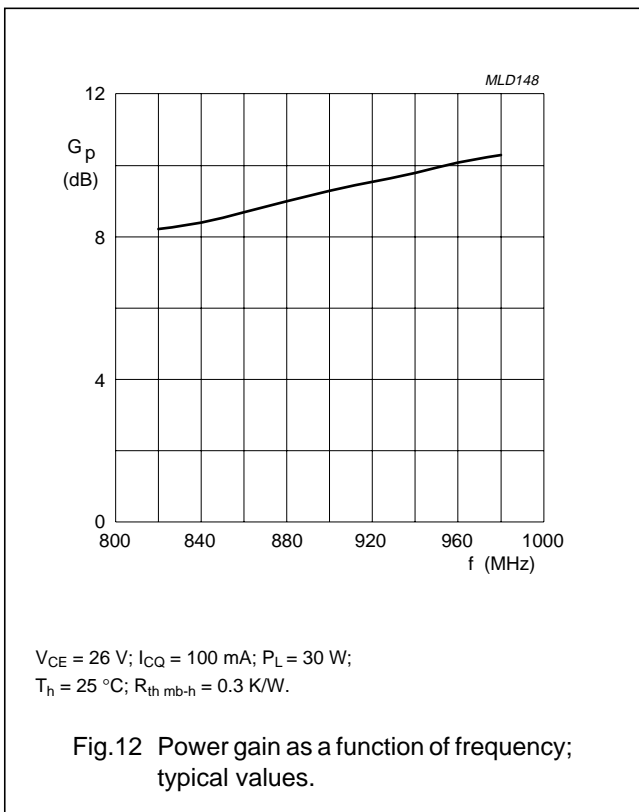
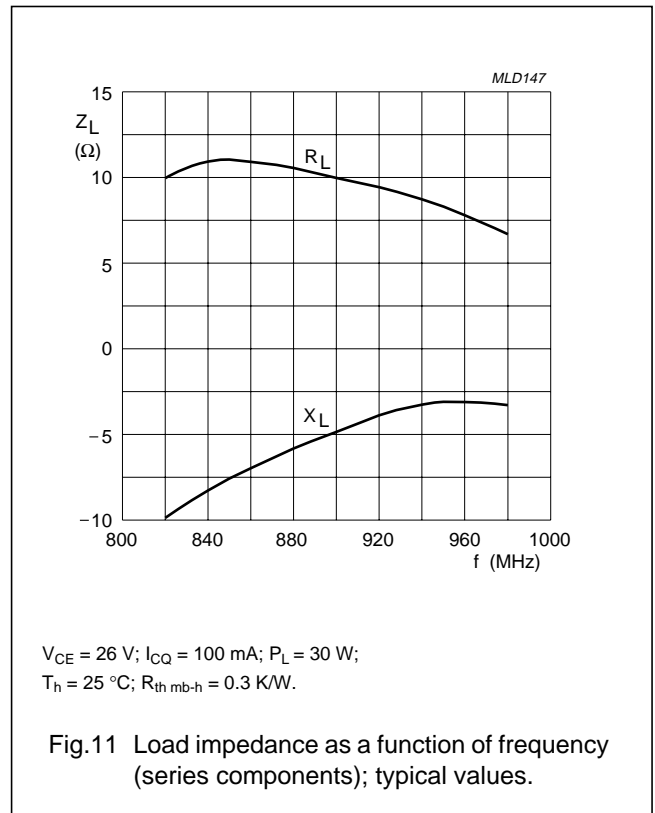
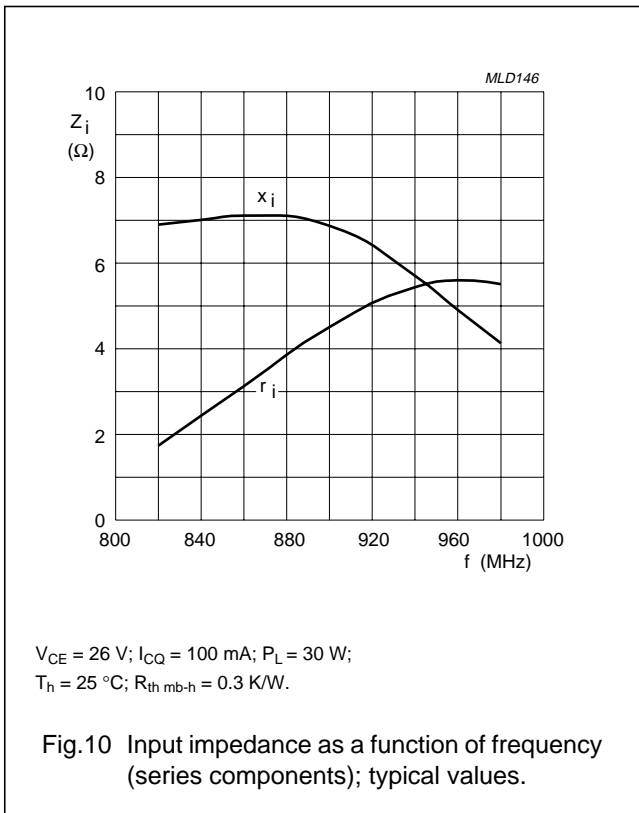

UHF power transistor

BLV935

PACKAGE OUTLINE

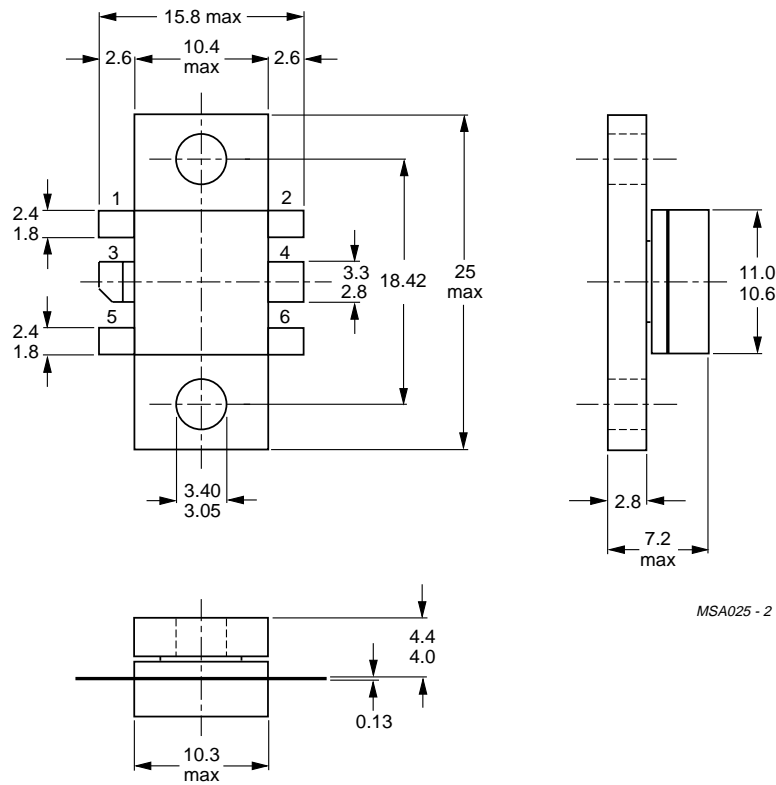

Dimensions in mm.

Torque on screw: min. 0.6 Nm; max. 0.75 Nm.

Recommended screw: cheese-head 4-40 UNC/2A.

Heatsink compound must be applied sparingly and evenly distributed.

Fig.14 SOT273.

## UHF power transistor

BLV935

**DEFINITIONS**

<b>Data Sheet Status</b>	
Objective specification	This data sheet contains target or goal specifications for product development.
Preliminary specification	This data sheet contains preliminary data; supplementary data may be published later.
Product specification	This data sheet contains final product specifications.
<b>Limiting values</b>	
Limiting values given are in accordance with the Absolute Maximum Rating System (IEC 134). Stress above one or more of the limiting values may cause permanent damage to the device. These are stress ratings only and operation of the device at these or at any other conditions above those given in the Characteristics sections of the specification is not implied. Exposure to limiting values for extended periods may affect device reliability.	
<b>Application information</b>	
Where application information is given, it is advisory and does not form part of the specification.	

**LIFE SUPPORT APPLICATIONS**

These products are not designed for use in life support appliances, devices, or systems where malfunction of these products can reasonably be expected to result in personal injury. Philips customers using or selling these products for use in such applications do so at their own risk and agree to fully indemnify Philips for any damages resulting from such improper use or sale.

## Philips Semiconductors – a worldwide company

**Argentina:** IEROD, Av. Juramento 1992 - 14.b, (1428)  
BUENOS AIRES, Tel. (541)786 7633, Fax. (541)786 9367

**Australia:** 34 Waterloo Road, NORTH RYDE, NSW 2113,  
Tel. (02)805 4455, Fax. (02)805 4466

**Austria:** Triester Str. 64, A-1101 WIEN, P.O. Box 213,  
Tel. (01)60 101-1236, Fax. (01)60 101-1211

**Belgium:** Postbus 90050, 5600 PB EINDHOVEN, The Netherlands,  
Tel. (31)40-2783749, Fax. (31)40-2788399

**Brazil:** Rua do Rocio 220 - 5<sup>th</sup> floor, Suite 51,  
CEP: 04552-903-SÃO PAULO-SP, Brazil,  
P.O. Box 7383 (01064-970),  
Tel. (011)821-2333, Fax. (011)829-1849

**Canada:** PHILIPS SEMICONDUCTORS/COMPONENTS:  
Tel. (800) 234-7381, Fax. (708) 296-8556

**Chile:** Av. Santa Maria 0760, SANTIAGO,  
Tel. (02)773 816, Fax. (02)777 6730

**China/Hong Kong:** 501 Hong Kong Industrial Technology Centre,  
72 Tat Chee Avenue, Kowloon Tong, HONG KONG,  
Tel. (852)2319 7888, Fax. (852)2319 7700

**Colombia:** IPRELENZO LTDA, Carrera 21 No. 56-17,  
77621 BOGOTA, Tel. (571)249 7624/(571)217 4609,  
Fax. (571)217 4549

**Denmark:** Prags Boulevard 80, PB 1919, DK-2300  
COPENHAGEN S, Tel. (45)32 88 26 36, Fax. (45)31 57 19 49

**Finland:** Sinikalliontie 3, FIN-02630 ESPOO,  
Tel. (358)0-615 800, Fax. (358)0-61580 920

**France:** 4 Rue du Port-aux-Vins, BP317,  
92156 SURESNES Cedex,  
Tel. (01)4099 6161, Fax. (01)4099 6427

**Germany:** P.O. Box 10 51 40, 20035 HAMBURG,  
Tel. (040)23 53 60, Fax. (040)23 53 63 00

**Greece:** No. 15, 25th March Street, GR 17778 TAVROS,  
Tel. (01)4894 339/4894 911, Fax. (01)4814 240

**India:** Philips INDIA Ltd, Shivsagar Estate, A Block,  
Dr. Annie Besant Rd. Worli, Bombay 400 018  
Tel. (022)4938 541, Fax. (022)4938 722

**Indonesia:** Philips House, Jalan H.R. Rasuna Said Kav. 3-4,  
P.O. Box 4252, JAKARTA 12950,  
Tel. (021)5201 122, Fax. (021)5205 189

**Ireland:** Newstead, Clonskeagh, DUBLIN 14,  
Tel. (01)7640 000, Fax. (01)7640 200

**Italy:** PHILIPS SEMICONDUCTORS S.r.l.,  
Piazza IV Novembre 3, 20124 MILANO,  
Tel. (0039)2 6752 2531, Fax. (0039)2 6752 2557

**Japan:** Philips Bldg 13-37, Kohnan2-chome, Minato-ku, TOKYO 108,  
Tel. (03)3740 5130, Fax. (03)3740 5077

**Korea:** Philips House, 260-199 Itaewon-dong,  
Yongsan-ku, SEOUL, Tel. (02)709-1412, Fax. (02)709-1415

**Malaysia:** No. 76 Jalan Universiti, 46200 PETALING JAYA,  
SELANGOR, Tel. (03)750 5214, Fax. (03)757 4880

**Mexico:** 5900 Gateway East, Suite 200, EL PASO, TX 79905,  
Tel. 9-5(800)234-7381, Fax. (708)296-8556

**Netherlands:** Postbus 90050, 5600 PB EINDHOVEN, Bldg. VB,  
Tel. (040)2783749, Fax. (040)2788399

**New Zealand:** 2 Wagener Place, C.P.O. Box 1041, AUCKLAND,  
Tel. (09)849-4160, Fax. (09)849-7811

**Norway:** Box 1, Manglerud 0612, OSLO,  
Tel. (022)74 8000, Fax. (022)74 8341

**Pakistan:** Philips Electrical Industries of Pakistan Ltd.,  
Exchange Bldg. ST-2/A, Block 9, KDA Scheme 5, Clifton,  
KARACHI 75600, Tel. (021)587 4641-49,  
Fax. (021)577035/5874546

**Philippines:** PHILIPS SEMICONDUCTORS PHILIPPINES Inc.,  
106 Valero St. Salcedo Village, P.O. Box 2108 MCC, MAKATI,  
Metro MANILA, Tel. (63) 2 816 6380, Fax. (63) 2 817 3474

**Portugal:** PHILIPS PORTUGUESA, S.A.,  
Rua dr. António Loureiro Borges 5, Arquiparque - Miraflores,  
Apartado 300, 2795 LINDA-A-VELHA,  
Tel. (01)4163160/4163333, Fax. (01)4163174/4163366

**Singapore:** Lorong 1, Toa Payoh, SINGAPORE 1231,  
Tel. (65)350 2000, Fax. (65)251 6500

**South Africa:** S.A. PHILIPS Pty Ltd.,  
195-215 Main Road Martindale, 2092 JOHANNESBURG,  
P.O. Box 7430, Johannesburg 2000,  
Tel. (011)470-5911, Fax. (011)470-5494

**Spain:** Balmes 22, 08007 BARCELONA,  
Tel. (03)301 6312, Fax. (03)301 42 43

**Sweden:** Kottbygatan 7, Akalla. S-164 85 STOCKHOLM,  
Tel. (0)8-632 2000, Fax. (0)8-632 2745

**Switzerland:** Allmendstrasse 140, CH-8027 ZÜRICH,  
Tel. (01)488 2211, Fax. (01)481 77 30

**Taiwan:** PHILIPS TAIWAN Ltd., 23-30F, 66, Chung Hsiao West  
Road, Sec. 1. Taipeh, Taiwan ROC, P.O. Box 22978,  
TAIPEI 100, Tel. (886) 2 382 4443, Fax. (886) 2 382 4444

**Thailand:** PHILIPS ELECTRONICS (THAILAND) Ltd.,  
209/2 Sanpavuth-Bangna Road Prakanong,  
Bangkok 10260, THAILAND,  
Tel. (66) 2 745-4090, Fax. (66) 2 398-0793

**Turkey:** Talatpasa Cad. No. 5, 80640 GÜLTEPE/ISTANBUL,  
Tel. (0212)279 27 70, Fax. (0212)282 67 07

**Ukraine:** Philips UKRAINE, 2A Akademika Koroleva str., Office 165,  
252148 KIEV, Tel. 380-44-4760297, Fax. 380-44-4766991

**United Kingdom:** Philips Semiconductors LTD.,  
276 Bath Road, Hayes, MIDDLESEX UB3 5BX,  
Tel. (0181)730-5000, Fax. (0181)754-8421

**United States:** 811 East Arques Avenue, SUNNYVALE,  
CA 94088-3409, Tel. (800)234-7381, Fax. (708)296-8556

**Uruguay:** Coronel Mora 433, MONTEVIDEO,  
Tel. (02)70-4044, Fax. (02)92 0601

**Internet:** <http://www.semiconductors.philips.com/ps/>

**For all other countries apply to:** Philips Semiconductors,  
International Marketing and Sales, Building BE-p,  
P.O. Box 218, 5600 MD EINDHOVEN, The Netherlands,  
Telex 35000 phtcnl, Fax. +31-40-2724825

SCDS47

© Philips Electronics N.V. 1996

All rights are reserved. Reproduction in whole or in part is prohibited without the prior written consent of the copyright owner.

The information presented in this document does not form part of any quotation or contract, is believed to be accurate and reliable and may be changed without notice. No liability will be accepted by the publisher for any consequence of its use. Publication thereof does not convey nor imply any license under patent- or other industrial or intellectual property rights.

Printed in The Netherlands

127041/500/01/pp12  
Document order number:

Date of release: 1995 Jun 29  
9397 750 00594