

M62334P/FP, M62339P/FP

8-bit 4ch I²C BUS D/A Converter with Buffer Amplifiers

REJ03D0866-0300

Rev.3.00

Jun 15, 2007

Description

The M62334/M62339 is an integrated circuit semiconductor of CMOS structure with 4 channels of built in D/A converters with output buffer operational amplifiers.

The input is 2-wires serial method is used for the transfer format of digital data to allow connection with a microcomputer with minimum wiring.

The output buffer operational amplifier employs AB class output circuit with sync and source drive capacity of 1.0 mA or more, and it operates in the whole voltage range from V_{CC} to ground.

The M62334 and the M62339 differ only in their slave address.

Features

- Digital data transfer format: I²C BUS serial data method
- Output buffer operational amplifier
It operates in the whole range from V_{CC} to ground.
- High output current drive capacity: 1.0 mA over

Application

Conversion from digital data to analog control data for home-use and industrial equipment.

Signal gain control or automatic adjustment of display-monitor or CTV.

Block Diagram

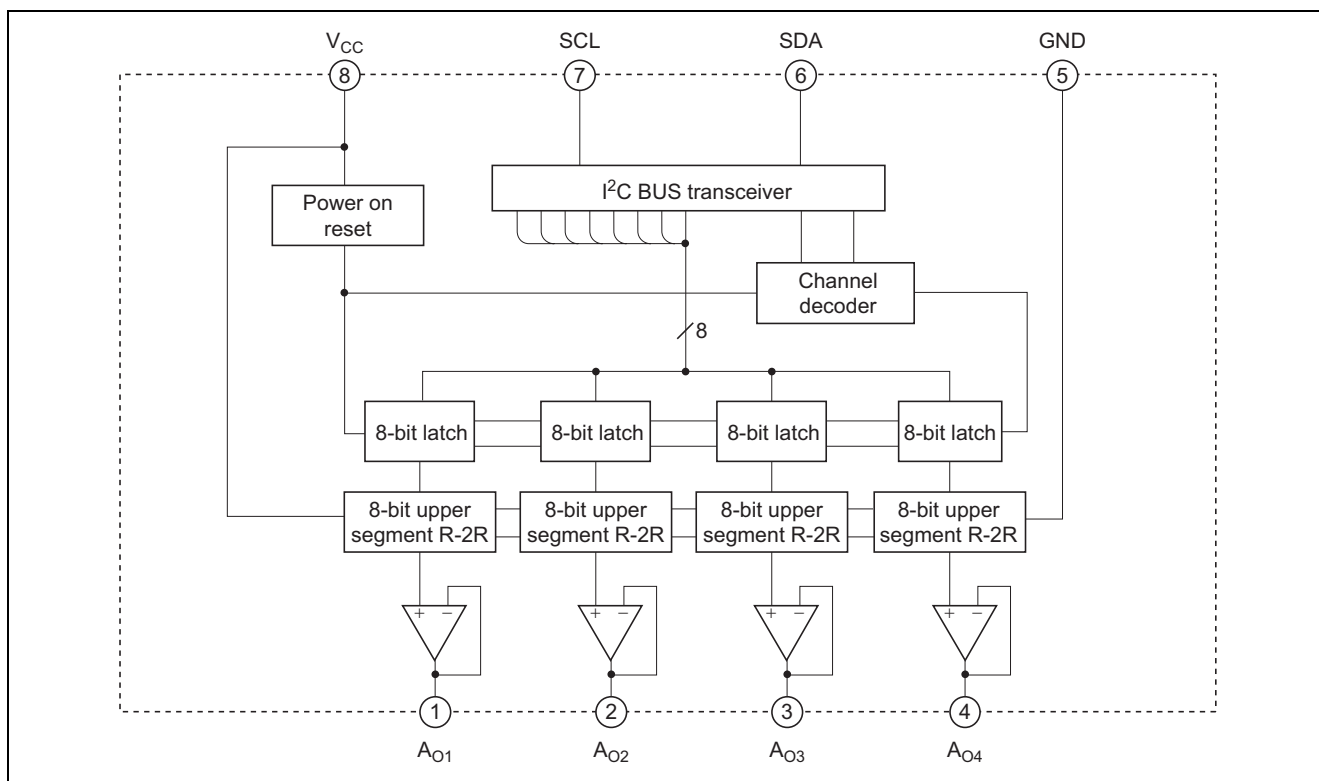

Pin Arrangement

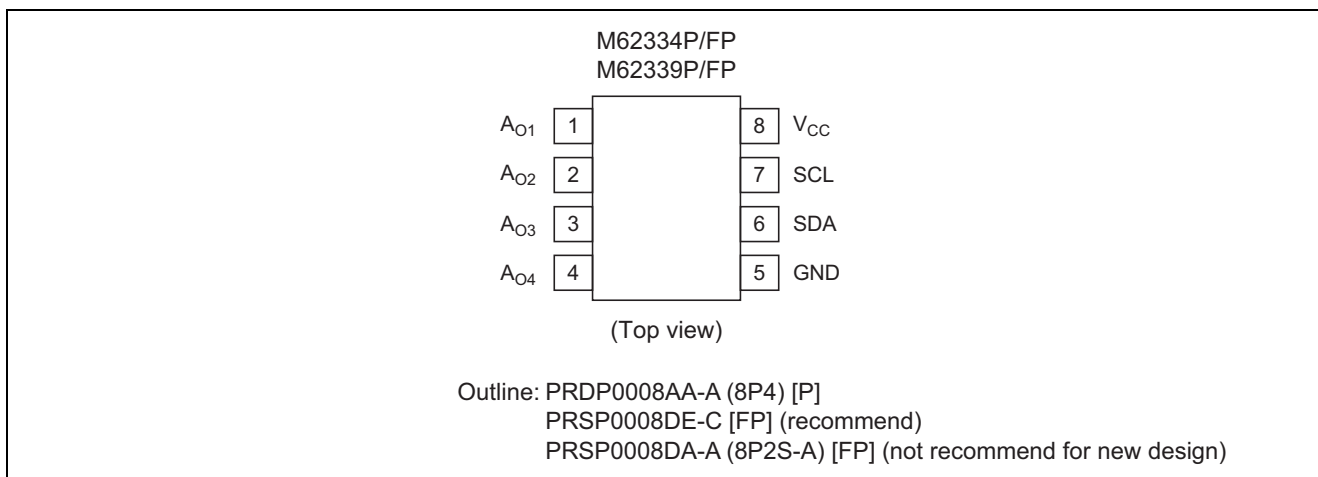

Pin Description

Pin No.	Pin Name	Function
6	SDA	Serial data input terminal
7	SCL	Serial clock input terminal
1	A _{O1}	8-bit resolution D/A converter output terminal
2	A _{O2}	
3	A _{O3}	
4	A _{O4}	
8	V _{CC}	Power supply terminal
5	GND	GND terminal

Absolute Maximum Ratings

Item	Symbol	Ratings	Unit
Supply voltage	V_{CC}	-0.3 to +7.0	V
Input voltage	V_{in}	-0.3 to $V_{CC} + 0.3$	V
Output voltage	V_O	-0.3 to $V_{CC} + 0.3$	V
Power dissipation	P_d	417 (P) / 272 (FP)	mW
Operating temperature	T_{opr}	-20 to +85	°C
Storage temperature	T_{stg}	-55 to +125	°C

Electrical Characteristics

($V_{CC} = +5\text{ V} \pm 10\%$, $GND = 0\text{ V}$, $T_a = -20\text{ to }+85^\circ\text{C}$ unless otherwise noted)

Item	Symbol	Limits			Unit	Test Conditions
		Min	Typ	Max		
Supply voltage	V_{CC}	2.7	5.0	5.5	V	
Supply current	I_{CC}	0	1.4	3.0	mA	CLK = 500 kHz operation, $I_{AO} = 0\ \mu\text{A}$ Data: 6Ah (at maximum current)
		0	0.9	2.0	mA	SDA = SCL = GND, $I_{AO} = 0\ \mu\text{A}$
Input leak current	I_{ILK}	-10	—	10	μA	$V_{IN} = 0\text{ to }V_{CC}$
Input low voltage	V_{IL}	0	—	$0.2 V_{CC}$	V	
Input high voltage	V_{IH}	$0.8 V_{CC}$	—	V_{CC}	V	
Buffer amplifier output voltage range	V_{AO}	0.1	—	$V_{CC} - 0.1$	V	$I_{AO} = \pm 100\ \mu\text{A}$
		0.2	—	$V_{CC} - 0.2$	V	$I_{AO} = \pm 500\ \mu\text{A}$
Buffer amplifier output drive range	I_{AO}	-1.0	—	1.0	mA	Upper side saturation voltage = 0.3 V Lower side saturation voltage = 0.2 V
Differential nonlinearity	S_{DL}	-1.0	—	1.0	LSB	$V_{CC} = 5.12\text{ V}$ (20 mV/LSB) without load ($I_{AO} = 0$)
Nonlinearity	S_L	-1.5	—	1.5	LSB	
Zero code error	S_{ZERO}	-2.0	—	2.0	LSB	
Full scale error	S_{FULL}	-2.0	—	2.0	LSB	
Output capacitance load	C_O	—	—	0.1	μF	
Buffer amplifier output impedance	R_O	—	5.0	—	Ω	

I²C BUS Line Characteristics

Item	Symbol	Min.	Max.	Unit
SCL clock frequency	f_{SCL}	0	100	kHz
Time the bus must be free before a new transmission can start	t_{BUF}	4.7	—	μ s
Hold time START condition (After this period, the first clock pulse is generated)	$t_{HD:STA}$	4.0	—	μ s
Low period of the clock	t_{LOW}	4.7	—	μ s
High period of the clock	t_{HIGH}	4.0	—	μ s
Set-up time for START condition (Only relevant for a repeated START condition)	$t_{SU:STA}$	4.7	—	μ s
Hold time DATA	$t_{HD:DAT}$	0	—	μ s
Set-up time DATA	$t_{SU:DAT}$	250	—	ns
Rise time of both SDA and SCL lines	t_R	—	1000	ns
Fall time of both SDA and SCL lines	t_F	—	300	ns
Set-up time for STOP condition	$t_{SU:STO}$	4.0	—	μ s

Note: Transmitter must internally provide at least a hold time to bridge the undefined region (300 ns Max) of the falling edge of SCL.

Timing Chart

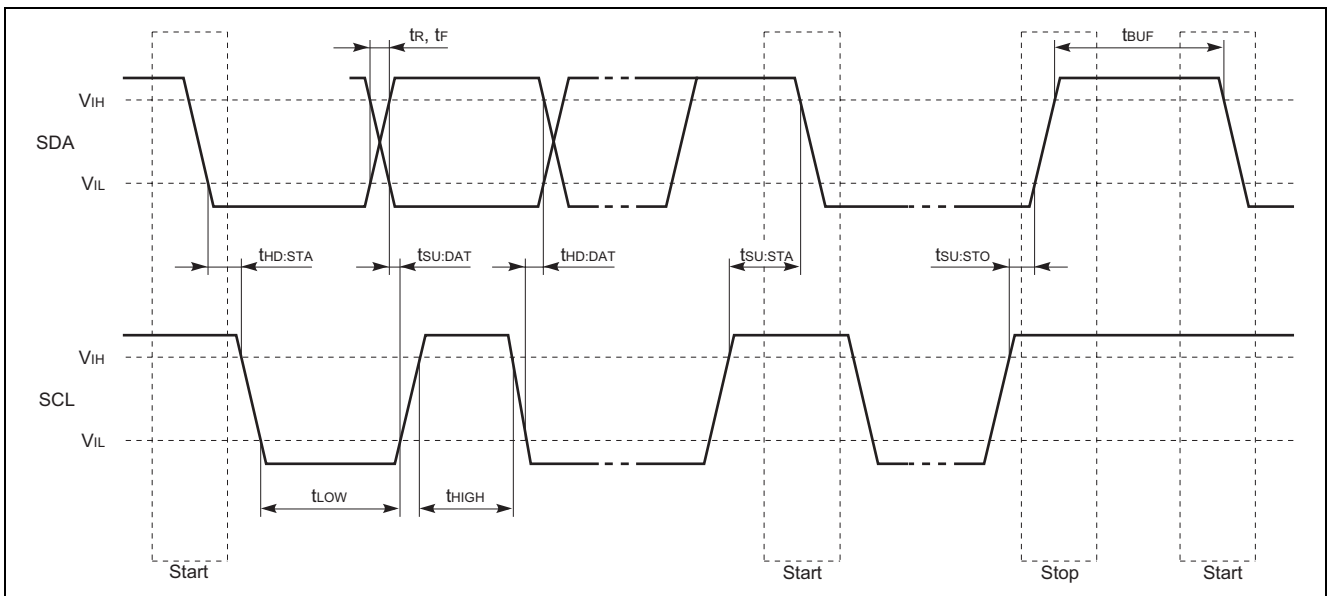

I²C BUS Format

STA	Slave address	W	A	Sub address	A	DAC data	A	STP
-----	---------------	---	---	-------------	---	----------	---	-----

Note: STA: start condition, A: affirmation bit, W: write (SDA = Low), STP: stop condition

- Slave address

M62334

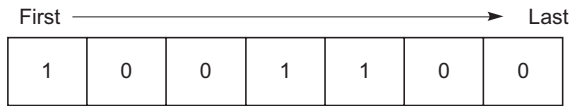

M62339

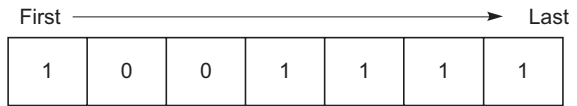

- Sub address

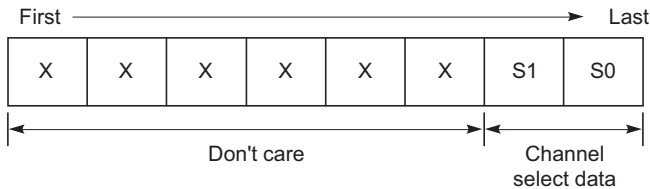

Channel select data

S1	S0	Channel Selection
0	0	ch1 selection
0	1	ch2 selection
1	0	ch3 selection
1	1	ch4 selection

- DAC data

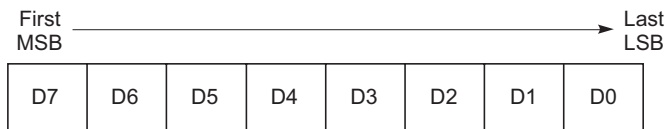

D7	D6	D5	D4	D3	D2	D1	D0	DAC output
0	0	0	0	0	0	0	0	$V_{CC} / 256 \times 1$
0	0	0	0	0	0	0	1	$V_{CC} / 256 \times 2$
0	0	0	0	0	0	1	0	$V_{CC} / 256 \times 3$
0	0	0	0	0	0	1	1	$V_{CC} / 256 \times 4$
:	:	:	:	:	:	:	:	:
1	1	1	1	1	1	1	0	$V_{CC} / 256 \times 255$
1	1	1	1	1	1	1	1	V_{CC}

Timing Chart (Model)

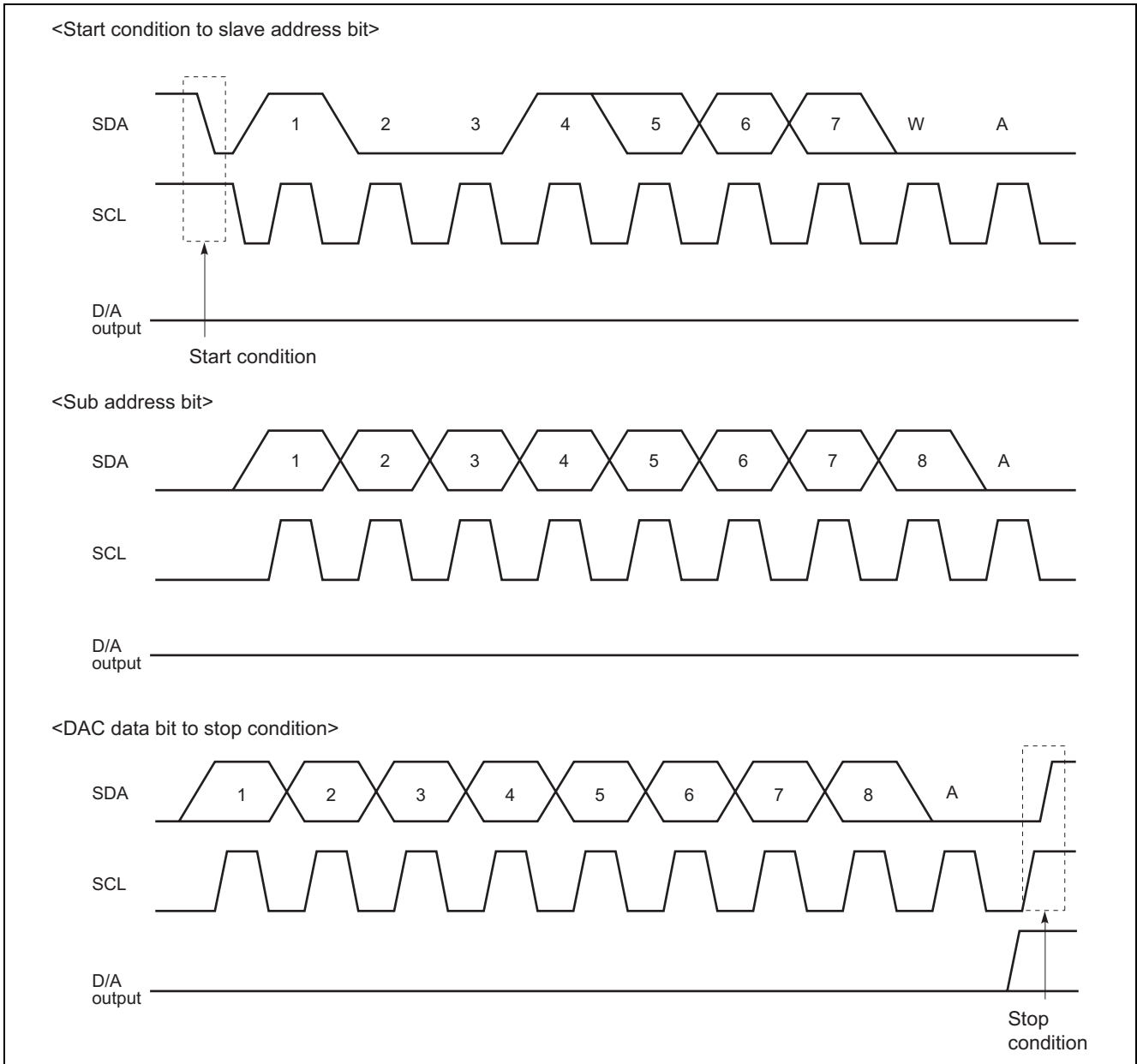

- Start condition With SCL at High, SDA line goes from High to Low
- Stop condition With SCL at High, SDA line goes from Low to High
(Under normal circumstance, SDA is changed when SCL is Low)
- Acknowledge bit The receiving IC has to pull down SDA line whenever receive slave data.
(The transmitting IC releases the SDA line just then transmit 8-bit data.)

Digital Data Formats

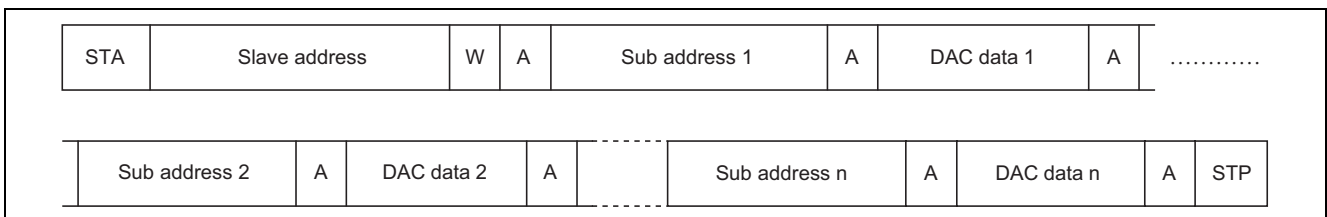

Precaution For use

- Supply voltage terminal (V_{CC}) is also used for D/A converter upper reference voltage setting. If ripple or spike is input this terminal, accuracy of D/A conversion is down. So, when use this device, please connect capacitor among V_{CC} to GND for stable D/A conversion.
- This IC's output amplifier has an advantage to capacitive load. So it's no problem at device action when connect capacitor (0.1 μF Max) among output to GND for every noise eliminate.
- Purchase of Renesas's I²C components conveys a license under the Philips I²C Patent Rights to use these components an I²C system, provided that the system conforms to I²C Standard Specification as defined by Philips.

Application Example

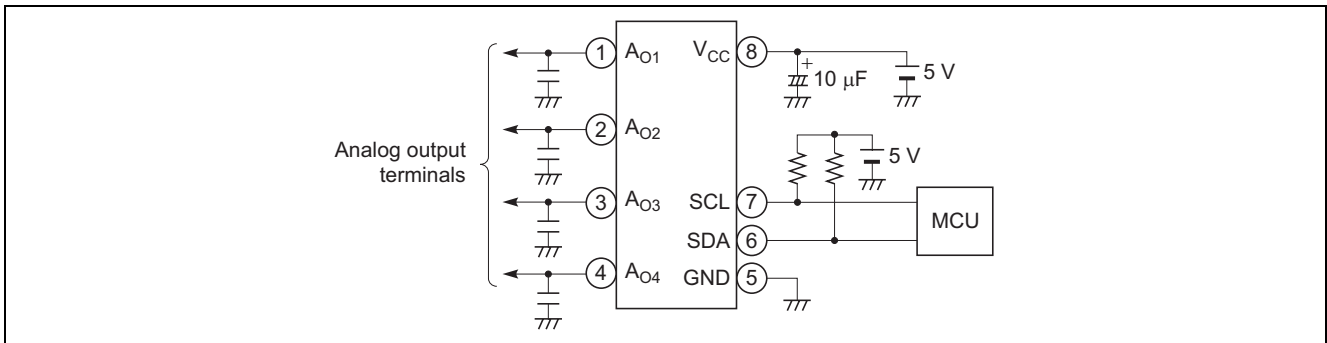

Package Dimensions

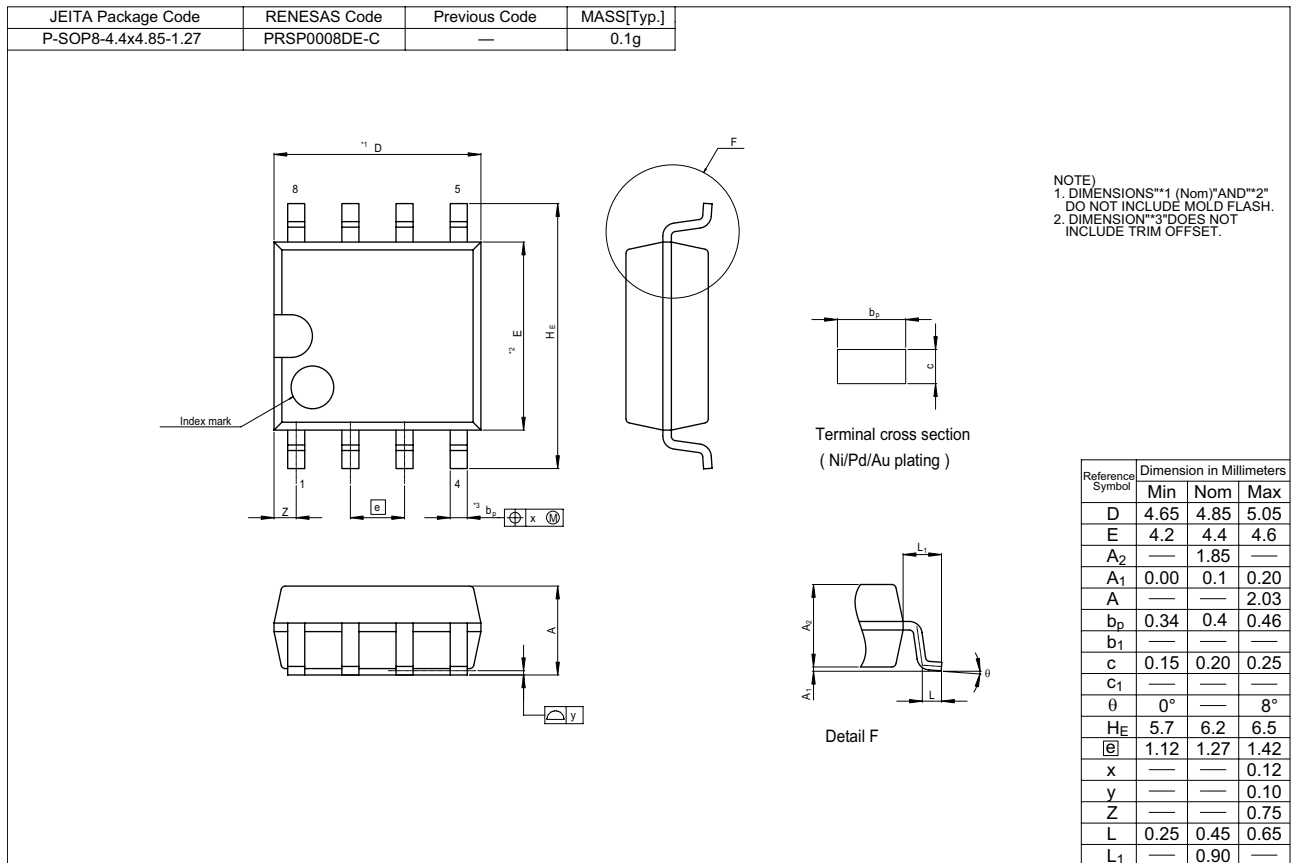
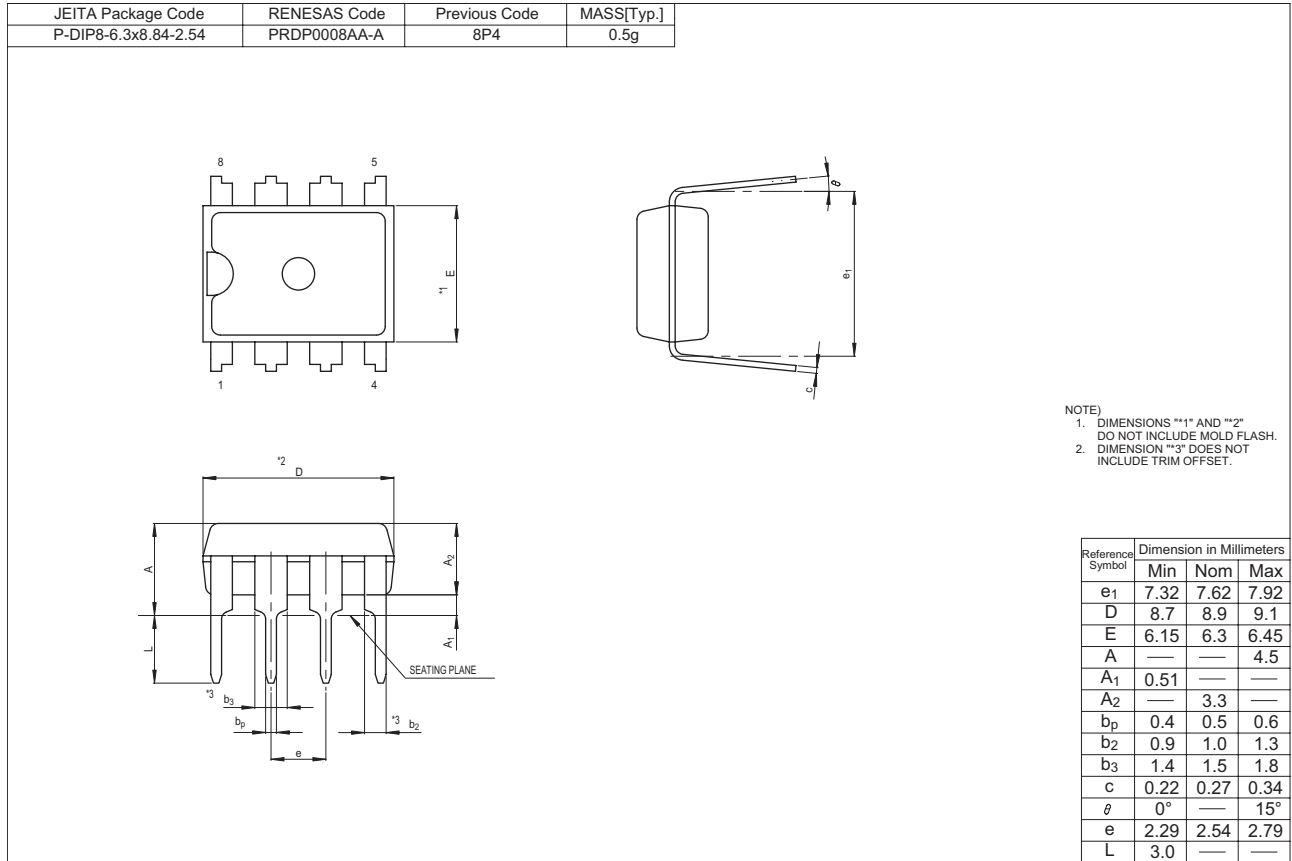

M62334P/FP, M62339P/FP

JEITA Package Code	RENESAS Code	Previous Code	MASS[Typ.]
P-SOP8-4.4x5-1.27	PRSP0008DA-A	8P2S-A	0.07g

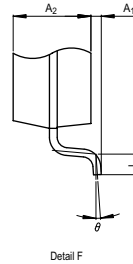
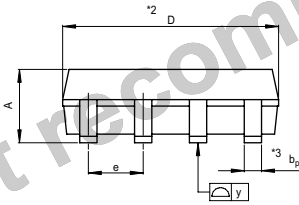
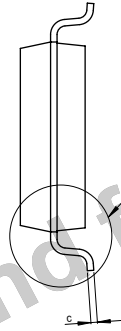
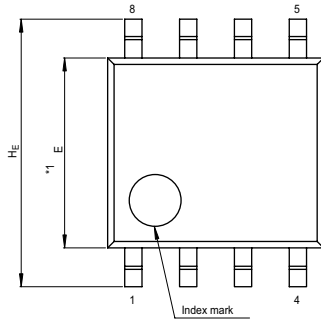

NOTE)
 1. DIMENSIONS $*1$ AND $*2$
 DO NOT INCLUDE MOLD FLASH.
 2. DIMENSION $*3$ DOES NOT
 INCLUDE TRIM OFFSET.

Reference Symbol	Dimension in Millimeters		
	Min	Nom	Max
D	4.8	5.0	5.2
E	4.2	4.4	4.6
A_2	—	1.5	—
A_1	0.05	—	—
A	—	—	1.9
b_p	0.35	0.4	0.5
c	0.13	0.15	0.2
θ	0°	—	10°
H_E	5.9	6.2	6.5
e	1.12	1.27	1.42
y	—	—	0.1
L	0.2	0.4	0.6

Notes:

1. This document is provided for reference purposes only so that Renesas customers may select the appropriate Renesas products for their use. Renesas neither makes warranties or representations with respect to the accuracy or completeness of the information contained in this document nor grants any license to any intellectual property rights or any other rights of Renesas or any third party with respect to the information in this document.
2. Renesas shall have no liability for damages or infringement of any intellectual property or other rights arising out of the use of any information in this document, including, but not limited to, product data, diagrams, charts, programs, algorithms, and application circuit examples.
3. You should not use the products or the technology described in this document for the purpose of military applications such as the development of weapons of mass destruction or for the purpose of any other military use. When exporting the products or technology described herein, you should follow the applicable export control laws and regulations, and procedures required by such laws and regulations.
4. All information included in this document such as product data, diagrams, charts, programs, algorithms, and application circuit examples, is current as of the date this document is issued. Such information, however, is subject to change without any prior notice. Before purchasing or using any Renesas products listed in this document, please confirm the latest product information with a Renesas sales office. Also, please pay regular and careful attention to additional and different information to be disclosed by Renesas such as that disclosed through our website. (<http://www.renesas.com>)
5. Renesas has used reasonable care in compiling the information included in this document, but Renesas assumes no liability whatsoever for any damages incurred as a result of errors or omissions in the information included in this document.
6. When using or otherwise relying on the information in this document, you should evaluate the information in light of the total system before deciding about the applicability of such information to the intended application. Renesas makes no representations, warranties or guaranties regarding the suitability of its products for any particular application and specifically disclaims any liability arising out of the application and use of the information in this document or Renesas products.
7. With the exception of products specified by Renesas as suitable for automobile applications, Renesas products are not designed, manufactured or tested for applications or otherwise in systems the failure or malfunction of which may cause a direct threat to human life or create a risk of human injury or which require especially high quality and reliability such as safety systems, or equipment or systems for transportation and traffic, healthcare, combustion control, aerospace and aeronautics, nuclear power, or undersea communication transmission. If you are considering the use of our products for such purposes, please contact a Renesas sales office beforehand. Renesas shall have no liability for damages arising out of the uses set forth above.
8. Notwithstanding the preceding paragraph, you should not use Renesas products for the purposes listed below:
 - (1) artificial life support devices or systems
 - (2) surgical implantations
 - (3) healthcare intervention (e.g., excision, administration of medication, etc.)
 - (4) any other purposes that pose a direct threat to human lifeRenesas shall have no liability for damages arising out of the uses set forth in the above and purchasers who elect to use Renesas products in any of the foregoing applications shall indemnify and hold harmless Renesas Technology Corp., its affiliated companies and their officers, directors, and employees against any and all damages arising out of such applications.
9. You should use the products described herein within the range specified by Renesas, especially with respect to the maximum rating, operating supply voltage range, movement power voltage range, heat radiation characteristics, installation and other product characteristics. Renesas shall have no liability for malfunctions or damages arising out of the use of Renesas products beyond such specified ranges.
10. Although Renesas endeavors to improve the quality and reliability of its products, IC products have specific characteristics such as the occurrence of failure at a certain rate and malfunctions under certain use conditions. Please be sure to implement safety measures to guard against the possibility of physical injury, and injury or damage caused by fire in the event of the failure of a Renesas product, such as safety design for hardware and software including but not limited to redundancy, fire control and malfunction prevention, appropriate treatment for aging degradation or any other applicable measures. Among others, since the evaluation of microcomputer software alone is very difficult, please evaluate the safety of the final products or system manufactured by you.
11. In case Renesas products listed in this document are detached from the products to which the Renesas products are attached or affixed, the risk of accident such as swallowing by infants and small children is very high. You should implement safety measures so that Renesas products may not be easily detached from your products. Renesas shall have no liability for damages arising out of such detachment.
12. This document may not be reproduced or duplicated, in any form, in whole or in part, without prior written approval from Renesas.
13. Please contact a Renesas sales office if you have any questions regarding the information contained in this document, Renesas semiconductor products, or if you have any other inquiries.



RENESAS SALES OFFICES

<http://www.renesas.com>

Refer to "<http://www.renesas.com/en/network>" for the latest and detailed information.

Renesas Technology America, Inc.

450 Holger Way, San Jose, CA 95134-1368, U.S.A
Tel: <1> (408) 382-7500, Fax: <1> (408) 382-7501

Renesas Technology Europe Limited

Dukes Meadow, Millboard Road, Bourne End, Buckinghamshire, SL8 5FH, U.K.
Tel: <44> (1628) 585-100, Fax: <44> (1628) 585-900

Renesas Technology (Shanghai) Co., Ltd.

Unit 204, 205, AZIACenter, No.1233 Lujiazui Ring Rd, Pudong District, Shanghai, China 200120
Tel: <86> (21) 5877-1818, Fax: <86> (21) 6887-7898

Renesas Technology Hong Kong Ltd.

7th Floor, North Tower, World Finance Centre, Harbour City, 1 Canton Road, Tsimshatsui, Kowloon, Hong Kong
Tel: <852> 2265-6688, Fax: <852> 2730-6071

Renesas Technology Taiwan Co., Ltd.

10th Floor, No.99, Fushing North Road, Taipei, Taiwan
Tel: <886> (2) 2715-2888, Fax: <886> (2) 2713-2999

Renesas Technology Singapore Pte. Ltd.

1 Harbour Front Avenue, #06-10, Keppel Bay Tower, Singapore 098632
Tel: <65> 6213-0200, Fax: <65> 6278-8001

Renesas Technology Korea Co., Ltd.

Kukje Center Bldg. 18th Fl., 191, 2-ka, Hangang-ro, Yongsan-ku, Seoul 140-702, Korea
Tel: <82> (2) 796-3115, Fax: <82> (2) 796-2145

Renesas Technology Malaysia Sdn. Bhd

Unit 906, Block B, Menara Amcorp, Amcorp Trade Centre, No.18, Jalan Persiaran Barat, 46050 Petaling Jaya, Selangor Darul Ehsan, Malaysia
Tel: <603> 7955-9390, Fax: <603> 7955-9510