

FR1A THRU FR1K

SURFACE MOUNT FAST SWITCHING RECTIFIER
VOLTAGE - 50 TO 800 Volts CURRENT - 1.0 Ampere

FEATURES

- For surface mounted applications
- Low profile package
- Built-in strain relief
- Easy pick and place
- Fast recovery times for high efficiency
- Plastic package has Underwriters Laboratory Flammability Classification 94V-0
- Glass passivated junction
- High temperature soldering:
260°C/10 seconds at terminals

MECHANICAL DATA

Case: JEDEC DO-214AA molded plastic
 Terminals: Solder plated solderable per MIL-STD-750, Method 2026
 Polarity: Indicated by cathode band
 Standard Packaging: 12mm tape (EIA-481)
 Weight: 0.003 ounces, 0.093 gram

SMB/DO-214AA

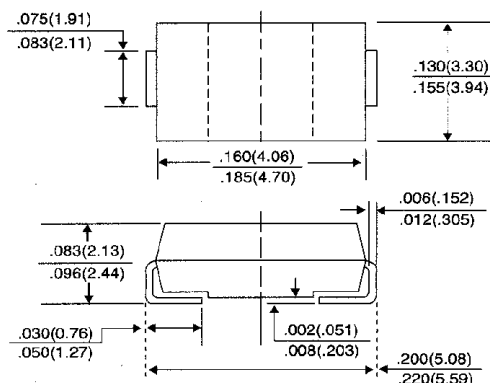

Dimensions in inches and (millimeters)

MAXIMUM RATINGS AND ELECTRICAL CHARACTERISTICS

Ratings at 25°C ambient temperature unless otherwise specified.
 Resistive or inductive load.
 For capacitive load, derate current by 20%.

	SYMBOLS	FR1A	FR1B	FR1D	FR1G	FR1J	FR1K	UNITS
Maximum Recurrent Peak Reverse Voltage	VRRM	50	100	200	400	600	800	Volts
Maximum RMS Voltage	VRMS	35	70	140	280	420	560	Volts
Maximum DC Blocking Voltage	VDC	50	100	200	400	600	800	Volts
Maximum Average Forward Rectified Current at T _L = 90°C	I(AV)	1.0						Amps
Peak Forward Surge Current 8.3ms single half sine-wave superimposed on rated load (JEDEC Method)	IFSM	30						Amps
Maximum Instantaneous Forward Voltage at 1.0A	V _F	1.3						Volts
Maximum DC Reverse Current T _A = 25°C at Rated DC Blocking Voltage T _A = 125°C	I _R	5.0 150						μA
Maximum Reverse Recovery Time (NOTE 1) T _J = 25°C	T _{RR}	150				250	500	nS
Typical Junction Capacitance (NOTE 2)	C _J	12						pf
Maximum Thermal Resistance (NOTE 3)	RθJL	30						°C/W
Operating and Storage Temperature Range	T _J , T _{STG}	-50 to +150						°C

NOTES:

1. Reverse Recovery Test Conditions: I_F = 0.5A, I_R = 1.0A, I_{rr} = 0.25A.
2. Measured at 1.0 MHz and applied reverse voltage of 4.0 volts.
3. 8.0mm² (.013mm thick) land areas.

RATING AND CHARACTERISTIC CURVES
FR1A THRU FR1K

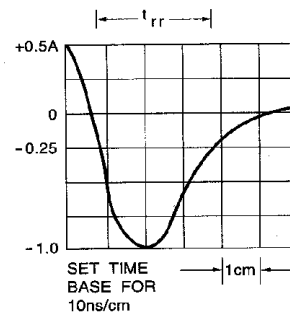
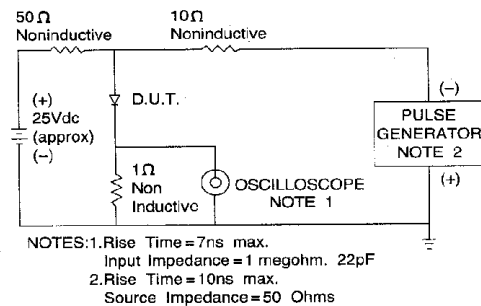
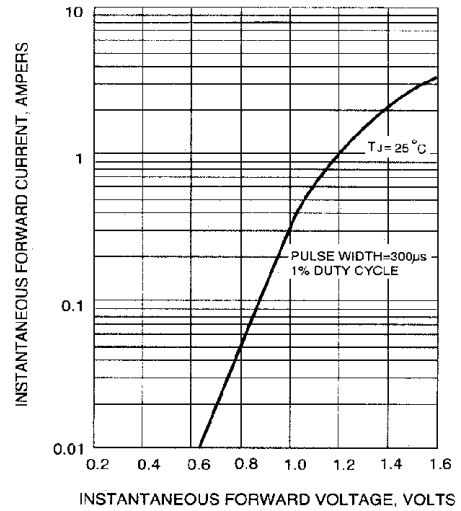
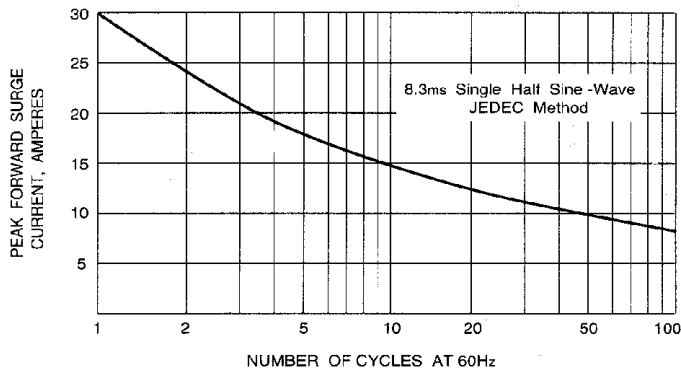
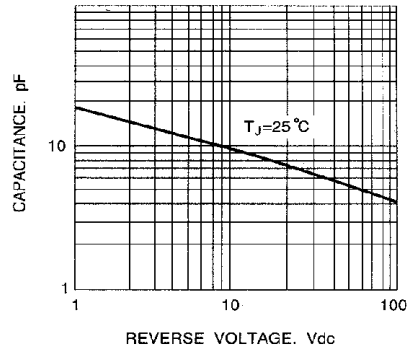
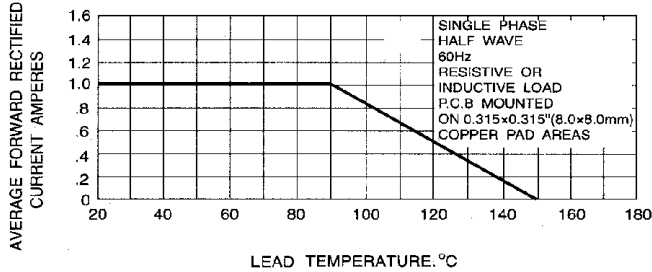

Fig. 5-REVERSE RECOVERY TIME CHARACTERISTIC AND TEST CIRCUIT DIAGRAM