

International Rectifier IRFK3D350, IRFK3F350

Isolated Base Power HEX-pak™ Assembly - Half Bridge Configuration

- High Current Capability.
- UL recognised E78996.
- Electrically Isolated Base Plate.
- Easy Assembly into Equipment.

Description

The HEX-pak™ utilises the well-proven HEXFET™ die, combining low on-state resistance with high transconductance. These superior technology die are assembled by state of the art techniques into the TO-240 package, featuring 2.5kV rms isolation and solid M5 screw connections. The small footprint means the package is highly suited to power applications where space is a premium. Available in two versions, IRFK.D... for fast switching and IRFK.F... for oscillation sensitive applications.

$$V_{DS} = 400V$$

$$R_{DS(on)} = 100m\Omega$$

$$I_D = 37A$$

Absolute Maximum Rating

	Parameter	Max.	Units
$I_D @ T_C=25^\circ C$	Continuous Drain Current	37	A
$I_D @ T_C=100^\circ C$	Continuous Drain Current	21	A
I_{DM}	Pulse Drain Current	148	A ①
$P_D @ T_C=25^\circ C$	Maximum Power Dissipation	625	W
V_{GS}	Gate-to-Source Voltage	20	V
V_{INS}	R.M.S. Isolation Voltage, circuit to base	2.5	kV
T_J	Operating Junction Temperature Range	-40 to 150	°C
T_{STG}	Storage Temperature Range	-40 to 150	°C

Thermal and Mechanical Specifications

	Parameter	Min.	Typ.	Max.	Units
R_{thJC}	Junction-to-Case	-	-	0.20	K/W ②
R_{thCS}	Case-to-Sink, smooth & greased surface	-	0.1	-	K/W
T	Mounting Torque +10%				③
	HEXpak to Heatsink	-	5	-	Nm
	Busbar to HEXpak	-	3	-	Nm
wt	Approximate Weight	-	140	-	g
		-	5	-	oz

Notes:

- ① - Repetitive Rating: Pulse width limited by maximum junction temperature see figure 8.
- ② - Per Module.
- ③ - A mounting compound is recommended and the torque should be rechecked after a period of three hours to allow for the spread of the compound.

IRFK3D350, IRFK3F350



Electrical Characteristics @ $T_j = 25^\circ\text{C}$ (Unless otherwise specified)

	Parameter	Min.	Typ.	Max.	Units	Test Conditions	
$B_{V_{DS}}$	Drain-to-Source Breakdown voltage	400	-	-	V	$V_{GS}=0\text{V}$, $I_D=1.0\text{mA}$	
$R_{DS(on)}$	Static Drain-to-Source On-State Resistance	-	80	100	$\text{m}\Omega$	$V_{GS}=10\text{V}$, $I_D=21\text{A}$	
$I_{D(on)}$	On-State Drain Current	37	-	-	A	$V_{DS} > I_{D(on)} \times R_{DS(on)}$ max, $V_{GS}=10\text{V}$	
$V_{GS(th)}$	Gate Threshold Voltage	2.0	-	4.0	V	$V_{DS}=V_{GS}$, $I_D=1.0\text{mA}$	
g_{fs}	Forward Transconductance ④	29	42	-	S	$V_{DS} > 50\text{V}$, $I_D=21\text{A}$	
I_{DSS}	Zero Gate Voltage Drain Current	-	-	0.75	mA	$V_{DS}=V_{DSmax}$, $V_{GS}=0\text{V}$	
		-	-	3.0	mA	$V_{GS}=10\text{V}$, $T_C=125^\circ\text{C}$, $V_{DS}=V_{DSmax} \times 0.8$	
I_{GSS}	Gate-to-Source Leakage Forward	-	-	300	nA	$V_{GS}=20\text{V}$	
I_{GSS}	Gate-to-Source Leakage Reverse	-	-	-300	nA	$V_{GS}=-20\text{V}$	
Q_g	Total Gate Charge	-	320	390	nC	$I_D=37\text{A}$, $V_{GS}=10\text{V}$	
Q_{gs}	Gate-to-Source Charge	-	36	54	nC	$V_{DS}=V_{DSmax} \times 0.8$	
Q_{gd}	Gate-to-Drain ("Miller") Charge	-	147	219	nC		
$t_{d(on)}$	Turn-on Delay Time	IRFK3D350	-	40	-	ns	$V_{DD}=180\text{V}$, $I_D=21\text{A}$, $V_{GS}=10\text{V}$,
		IRFK3F350	-	45	-	ns	
t_r	Rise Time	IRFK3D350	-	50	-	ns	$R_{SOURCE}=3.3\Omega$
		IRFK3F350	-	65	-	ns	
$t_{d(off)}$	Turn-off Delay Time	IRFK3D350	-	180	-	ns	
		IRFK3F350	-	240	-	ns	
t_f	Fall Time	IRFK3D350	-	40	-	ns	
		IRFK3F350	-	65	-	ns	
L_{DS}	Drain-to-Source Inductance	-	18	-	nH		
C_{iss}	Input Capacitance	-	8.0	-	nF	$V_{GS}=0\text{V}$, $V_{DS}=25\text{V}$,	
C_{oss}	Output Capacitance	-	2.2	-	nF	$f=1.0\text{MHz}$	
C_{rss}	Reverse Transfer Capacitance	-	0.8	-	nF		
	Linear Derating Factor	-	-	5	W/K		

Source-Drain Diode Ratings and Characteristics

	Parameter	Min.	Typ.	Max.	Units	Test Conditions
I_S	Continuous Source Current (Body Diode)	-	-	37	A	
I_{SM}	Pulsed Source Current (Body Diode)	-	-	130	A	
V_{SD}	Diode Forward Voltage	-	-	1.6	V	$V_{GS}=0\text{V}$, $I_S=37\text{A}$, $T_C=25^\circ\text{C}$
t_{rr}	Reverse Recovery Time	190	380	760	ns	$di/dt=400\text{A}/\mu\text{s}$, $T_j=150^\circ\text{C}$
Q_{rr}	Reverse Recovered Charge	7.2	14.0	28.0	μC	$I_S=37\text{A}$

Notes:

④ - Pulse Width $\leq 300\mu\text{s}$; Duty cycle $\leq 2\%$.



IRFK3D350, IRFK3F350

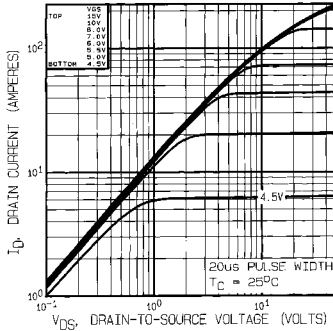

Fig 1. Typical Output Characteristics, $T_C = 25^\circ C$

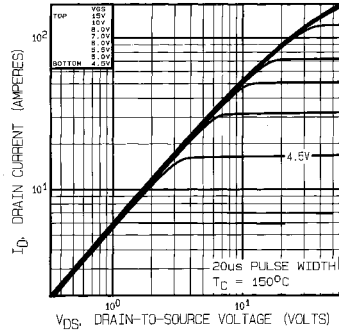

Fig 2. Typical Output Characteristics, $T_C = 150^\circ C$

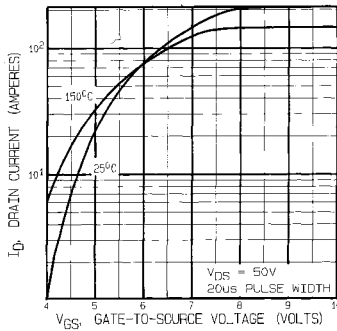

Fig 3. Typical Transfer Characteristics

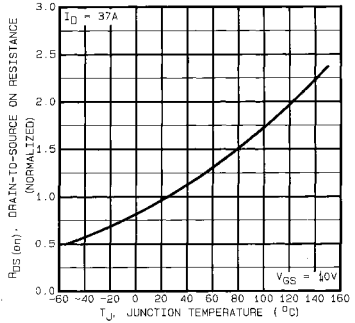

Fig 4. Normalized On-Resistance Vs. Temperature

IRFK3D350, IRFK3F350

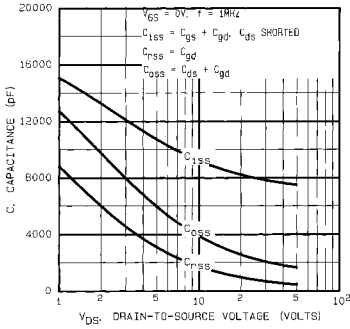

Fig 5. Typical Capacitance Vs. Drain-to-Source Voltage

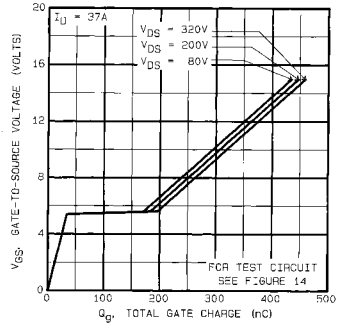

Fig 6. Typical Gate Charge Vs. Gate-to-Source Voltage

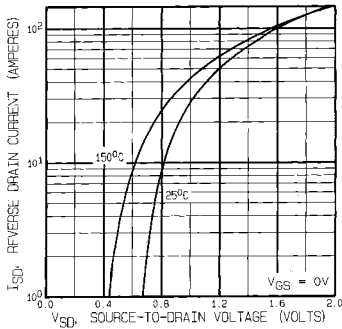

Fig 7. Typical Source-Drain Diode Forward Voltage

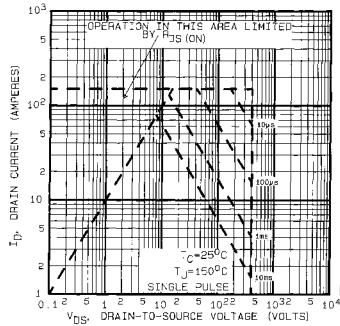

Fig 8. Maximum Safe Operating Area



IRFK3D350, IRFK3F350

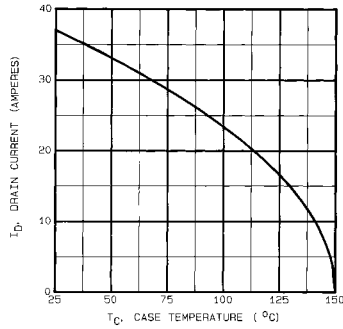

Fig 9. Maximum Drain Current Vs. Case Temperature

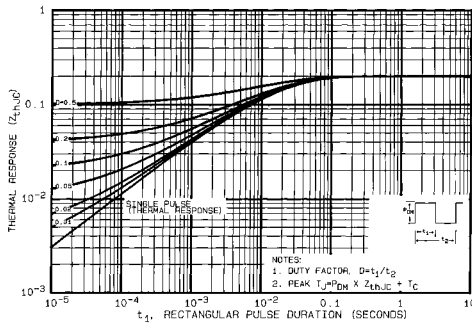

Fig 10. Maximum Effective Transient Thermal Impedance, Junction-to-Case

IRFK3D350, IRFK3F350

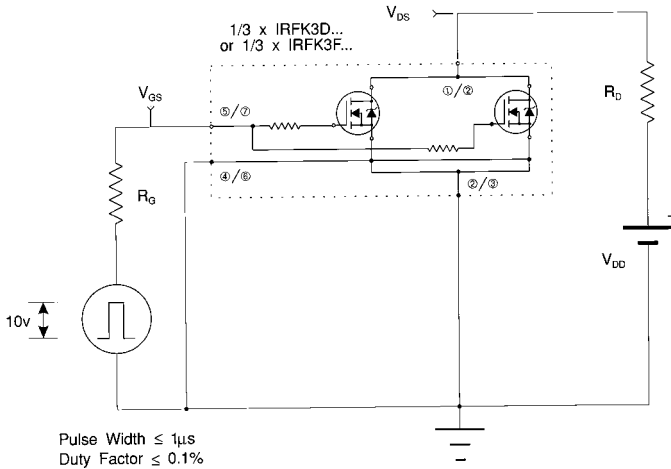

Fig 11a. Switching Time Test Circuit

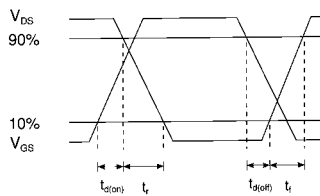
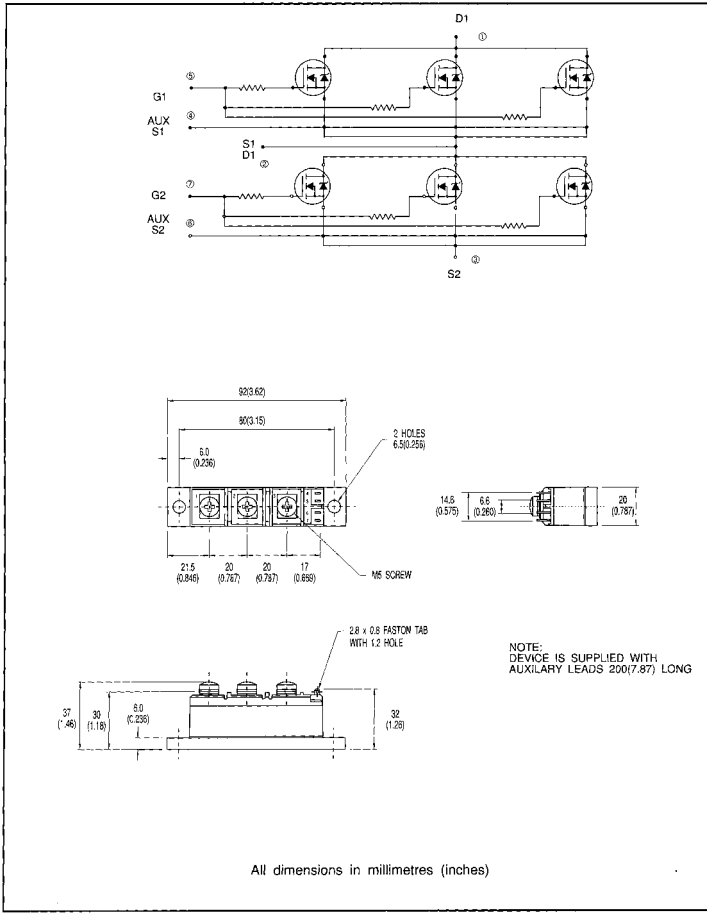

Fig 11b. Switching Time Waveforms



IRFK3D350,IRFK3F350

Circuit Configuration and Outline



IRFK3D350,IRFK3F350



Part Numbering

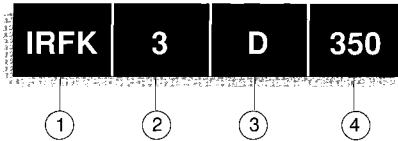

1. - HEX-pak Module.
2. - Number of arms of bridge.
3. - D - Fast switching.
- F - Oscillation resistant for sensitive applications.
4. - Voltage code:-
054 - 60V
150 - 100V
250 - 200V
350 - 400V
450 - 500V
C50 - 600V

WORLD HEADQUARTERS: 233 Kansas St., EL SEGUNDO, California 90245, USA. Tel:(213) 772-2000. Tlx:664464. Fax:(213) 772-9028
EUROPEAN HEADQUARTERS: Hurst Green, OXTEO, Surrey RH8 9BD, UK. Tel:(0983) 713215. Tlx:95219. Fax:(0983) 714234.

CANADA: 101 Bentley St., Markham, ONTARIO L3R 3L1. Tel:(416)475-1897. Tlx:06-966-650. Fax:(416)475-8801
CZECHOSLOVAKIA: Macurova 19/1565, Box 30, 140 00 PRAGUE. Tel:(2) 792 6831. Fax:(2) 792 6831.
DENMARK: P.O. Box 70, Kroghshøjvej 51, DK-2880 BAGSVAERD. Tel:(45) 44 37 71 50. Fax (45) 44 37 71 52.
FRANCE: 123 Rue de Petit Vaux, 91360 EPINAY sur ORGE. Tel:(1)64.54.83.29. Tlx:600943. Fax:(1)64.54.83.30
FINLAND: Biihkogsvägen 19, 02580 Sjunobä St. Tel:(0) 262 8144. Fax:(0) 262 8150.
GERMANY: Sauburgstr. 137, D-6360 BAD HOMBURG. Tel:(0)172 37065. Tlx:410404. Fax:(0)172 37065.
HUNGARY: Szent Istvan Park 15, H-1137 BUDAPEST. Tel:(1) 1298 822. Fax:(1) 1298 822.
HONG KONG: 202 Peter Building, 60 Queens Road Central, HONG KONG. Tel:(85) 252 36355. Fax: (85) 284 52908.
ITALY: Via Liguria 49, 10071 Borgaro, TORINO. Tel:(0)11470 14 84. Tlx:221257. Fax:(0)11470 42 90.
Via Zucca 8, 20017 Reno MILANO. Tel:(02)93 50 36 50. Fax:(02)93 50 36 55.
Via Arno 1, 40139 BOLOGNA. Tel:(05)149 54 80.
INDIA: 31 Greenacre, 5 Union Park, Khar (W), BOMBAY 400 052. Tel:(022)535026/533779/540242. Tlx:011-71481.
JAPAN: K & H Bldg 2F, 3-30-4 Nishi-Ikebukuro, Toshima-ku, TOKYO, Japan 171. Tel:(03)983 0641. Fax:(03)983 0642.
SINGAPORE: HEX 10-01 Fortuna Centre, 190 Middle Road, SINGAPORE 0718. Tel:(65)336 3922/337 4695/336 6286. Fax: (65)337 4692.
SWEDEN: Box. 85, S-162 12 Vällingby 1, STOCKHOLM. Tel:(08)870035. Fax:(08)874242.
SWITZERLAND: CH-8032 ZURICH, Kirchenweg 5. Tel:(01)386 8702/8686. Fax:(01)383 5108/2379.
U.S.A.:
Central Zone: 2401 Plum Grove Road, Suite 111, PALATINE, IL 60067. Tel:(312)397-0002. Fax:(312)397-0114.
Eastern Zone: 71 Grand Avenue, PALISADES PARK, NJ 07650. Tel:(201)943-4554. Fax:(201)943-5754.
Southern Zone: 800 Office Plaza Blvd., Suite 401, KISSIMMEE, FL 32743. Tel:(407)933-2263. Fax:(407)933-2293.
Western Zone: 222 Kansas Street, EL SEGUNDO, CA 90245. Tel:(213)607-8886. Fax:(213)640-6533.

Sales Offices, Agents and Distributors in Major Cities throughout the World.

In the interest of product improvement INTERNATIONAL RECTIFIER reserves the right to change specifications at any time without notice.

MJW/1/92