

MEDIUM POWER AMPLIFIER GaAs MMIC

■GENERAL DESCRIPTION

NJG1302V is a GaAs MMIC designed mainly for the final stage power amplifier of Japanese PHS handset, but suitable digital wireless phone and wireless LAN.

This amplifier has wide variable gain capability of 20dB dynamic range.

NJG1302V has input and output matching circuits internally and features low voltage and high efficiency operation. The output power of 21dBm is easily available with very low distortion.

■PACKAGE OUTLINE

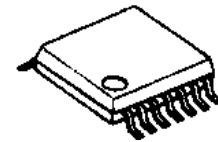

NJG1302V

■FEATURES

- Voltage gain under low distortion
- Low voltage operation
- Low current consumption
- High gain
- Low distortion (ACP)
- Reduction of Parasitic oscillation
- Input and output internal matching circuit
- Package

+3.0V typ.
 195mA typ. @f=1.9GHz, P_{OUT}=21dBm
 32dB
 -60dBc typ. @f=1.9GHz, P_{OUT}=21dBm

SSOP14 (Package size: 5.0x6.4x1.25mm)

■PIN CONFIGURATION

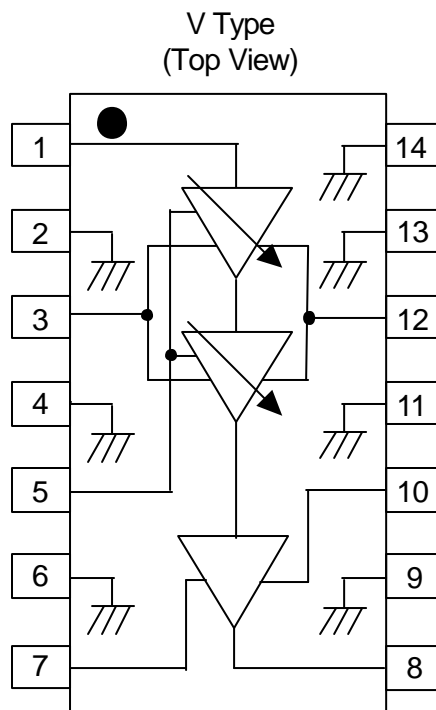

Pin connection

1. RFIN
2. GND
3. VGG1
4. GND
5. VCONT
6. GND
7. VGG2
8. RFOUT
9. GND
10. VDD2
11. GND
12. VDD1
13. GND
14. GND

NJG1302V

■ABSOLUTE MAXIMUM RATINGS

($T_a=+25^{\circ}\text{C}$, $Z_s=Z_l=50\Omega$)

PARAMETER	SYMBOL	CONDITIONS	RATINGS	UNITS
Drain Voltage	V_{DD1}, V_{DD2}	$V_{GG1}, V_{GG2}=-0.9\text{V}$	6	V
Gate Voltage	V_{GG1}, V_{GG2}	$V_{DD1}, V_{DD2}=3.0\text{V}$	-4	V
Gain Control Voltage	V_{CONT}	$V_{DD1}, V_{DD2}=3.0\text{V}$	-4	V
Input Power	P_{IN}	$V_{DD1}, V_{DD2}=3.0\text{V}, V_{GG1}, V_{GG2}=-0.9\text{V}$	3	dBm
Power Dissipation	P_D	At on PCB board	600	mW
Operating Temperature	T_{opr}		-30~+85	$^{\circ}\text{C}$
Storage Temperature	T_{stg}		-40~+150	$^{\circ}\text{C}$

■ELECTRICAL CHARACTERISTICS

($T_a=+25^{\circ}\text{C}$, $Z_s=Z_l=50\Omega$)

PARAMETER	SYMBOL	CONDITIONS	MIN	TYP	MAX	UNITS
Operating Frequency	freq	$V_{DD1, 2}=3.0\text{V}$	1.89	-	1.92	GHz
Drain Voltage	$V_{DD1, 2}$		2.9	3.0	5.0	V
Gate Voltage	$V_{GG1, 2}$	$V_{DD1, 2}=3.0\text{V}, I_{idle}=180\text{mA}$	-1.25	-0.9	-0.6	V
Idle Current *1	I_{idle}	$V_{DD1, 2}=3.0\text{V}$, No RF Signal	175	180	185	mA
Operating Current *1	I_{DD}	$V_{DD1, 2}=3.0\text{V}, P_{OUT}=21\text{dBm}$	-	195	205	mA
Gate Current *2	I_{GG}	$V_{DD1, 2}=3.0\text{V}, P_{OUT}=21\text{dBm}$	-150	-70	-	μA
Gain Control Terminal Current	I_{CONT}	$V_{DD1, 2}=3.0\text{V}, P_{OUT}=21\text{dBm}$ $-2.0 < V_{CONT} < 0.0\text{V}$	-5	-2	-	μA
Gain Control Voltage	V_{CONT}		-2.0	-	0	V
Small Signal Gain	Gain	$V_{DD1, 2}=3.0\text{V}, I_{idle}=180\text{mA}$	29	32	35	dB
Gain Flatness	G_{flat}	$V_{DD1, 2}=3.0\text{V}, I_{idle}=180\text{mA}$	0	0.5	1.0	dB
Gain Control Range	G_{CONT}	$V_{CONT}=-2\sim 0\text{V}, V_{DD1, 2}=3.0\text{V}$ $I_{idle}=180\text{mA}$	18	20	23	dB
Pout at 1dB Compression point	P_{-1dB}	$V_{DD1, 2}=3.0\text{V}$	22	23	-	dBm
Adjacent Channel Leakage Power 1	P_{acp1}	$V_{DD1, 2}=3.0\text{V}, P_{OUT}=21\text{dBm}$ offset=600kHz, $P_{IN}; \pi/4$ DQPSK	-	-60	-55	dBc
Adjacent Channel Leakage Power 2	P_{acp2}	$V_{DD1, 2}=3.0\text{V}, P_{OUT}=21\text{dBm}$ offset=900kHz, $P_{IN}; \pi/4$ DQPSK	-	-65	-60	dBc
Harmonics	P_{SP}	$V_{DD1, 2}=3.0\text{V}, P_{OUT}=21\text{dBm}$	-	-35	-30	dBc
Input VSWR	$VSWR_i$	$V_{DD1, 2}=3.0\text{V}$	-	-	2.2	
Load VSWR Tolerance	-	$V_{DD1, 2}=3.0\text{V}, P_{OUT}=21\text{dBm}$ Load VSWR=4:1, All Phase	Parasitic Oscillation for Fundamental Signal Level : $\leq -60\text{dBc}$			

*1: VDD1 Terminal VDD2 Terminal Total Current

*2: VGG1 Terminal VGG2 Terminal Total Current

TYPICAL CHARACTERISTICS

Gain vs. Frequency vs. Control Voltage
 ($V_{DD}=3.0V, I_{DD}=180mA, T_a=25^\circ C$)

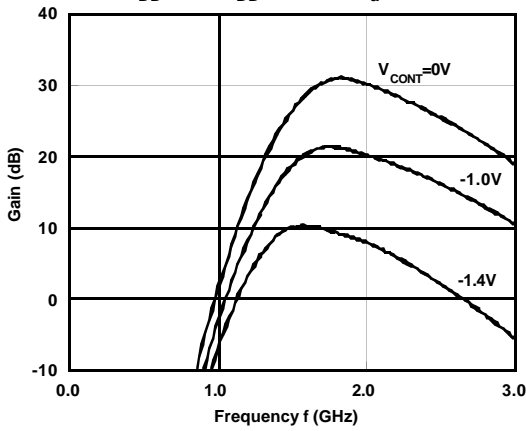

P_{acp} vs. Operating Current vs. V_{DD}
 ($P_{out}=21dBm, V_{cont}=0V, f=1.9GHz, T_a=25^\circ C$)

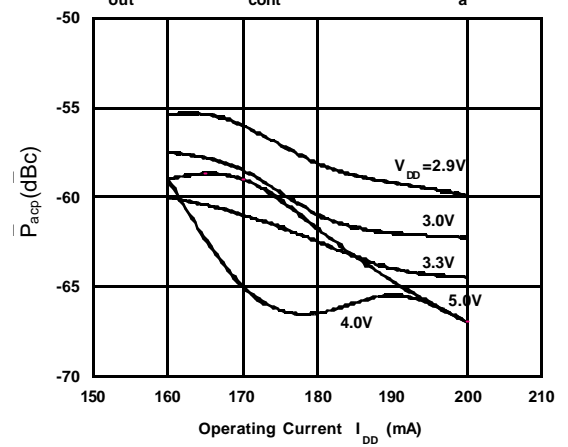

Output Power, Operating Current vs. Input Power
 ($V_{DD}=3.0V, V_{cont}=0V, I_{idle}=180mA, f=1.9GHz, T_a=25^\circ C$)

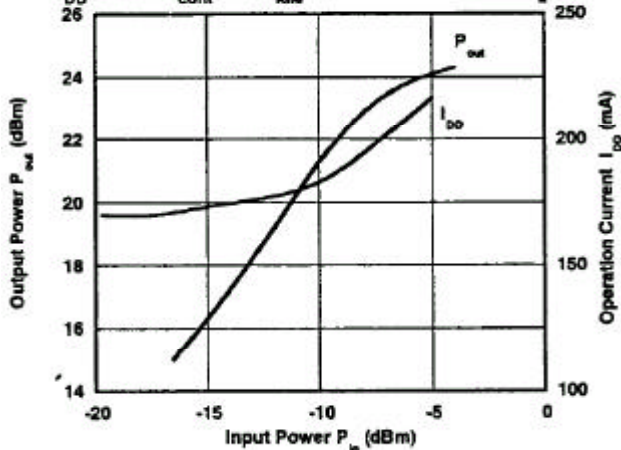

Output Power vs. Input Power vs. Control Voltage
 ($V_{DD}=3.0V, I_{idle}=180mA, f=1.9GHz, T_a=25^\circ C$)

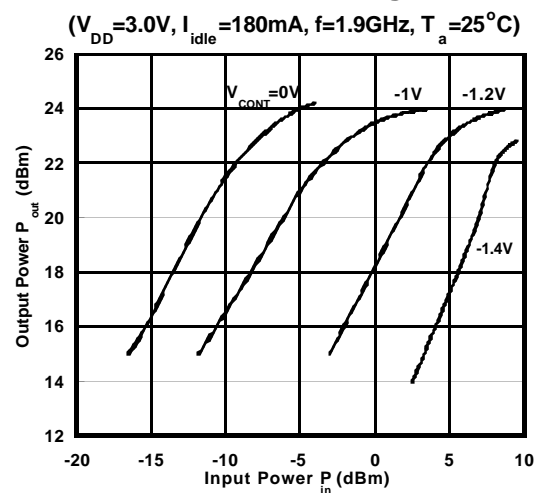

Output Power, Gate Current vs. Input Power

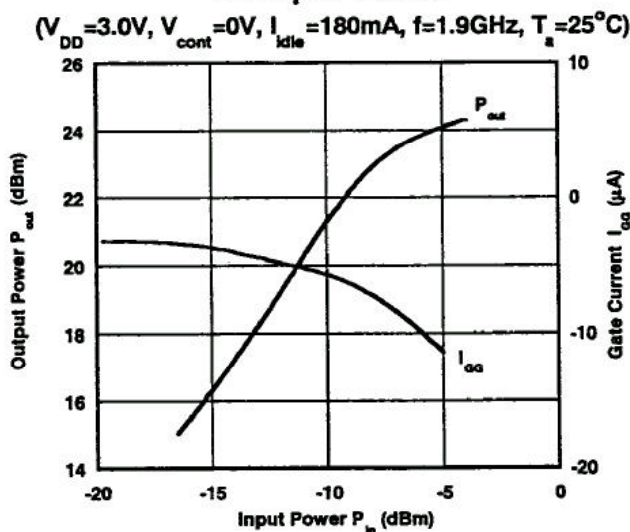

P_{acp} vs. Input Power vs. Control Voltage
 ($V_{DD}=3.0V, I_{idle}=180mA, f=1.9GHz, T_a=25^\circ C$)

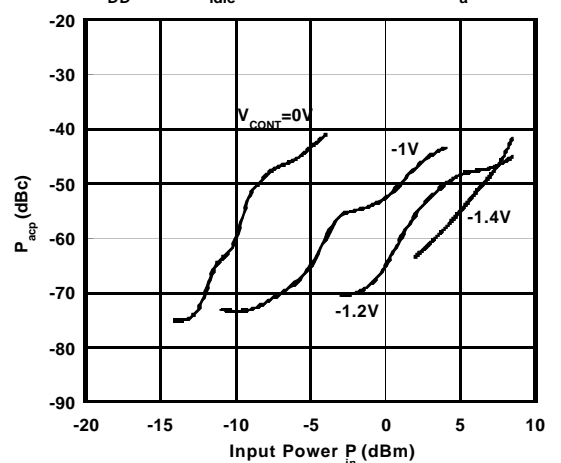

TYPICAL CHARACTERISTICS

Output Power, P_{out} vs. Control Voltage

($V_{DD}=3.0V$, $I_{idle}=180mA$, $f=1.9GHz$, $P_{in}=-11dBm$, $T_a=25^\circ C$)

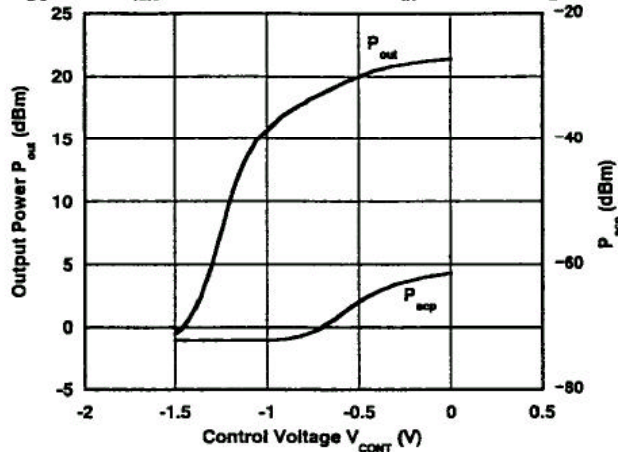

Gain, P_{acp} vs. Ambient Temperature

($V_{DD}=3.0V$, $V_{cont}=0V$, $I_{idle}=180mA$, $P_{out}=21dBm$, $f=1.9GHz$)

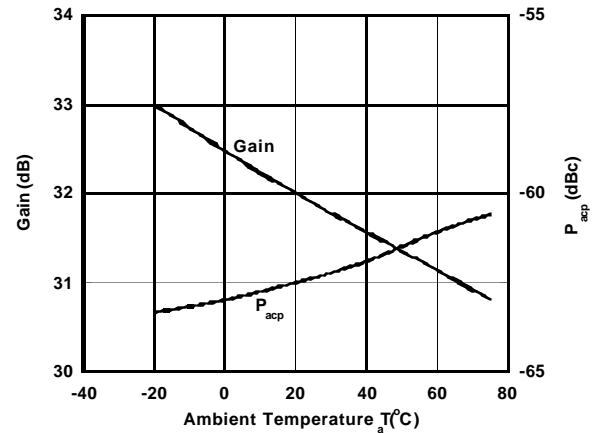

Operating Current, I_{DD} vs. Control Voltage

($V_{DD}=3.0V$, $I_{idle}=180mA$, $f=1.9GHz$, $P_{in}=-11dBm$, $T_a=25^\circ C$)

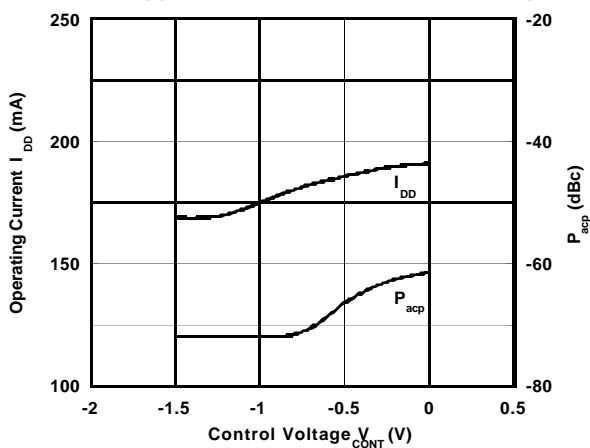

Operating Current vs. Ambient Temperature

($V_{DD}=3.0V$, $V_{cont}=0V$, $I_{idle}=180mA$, $P_{out}=21dBm$, $f=1.9GHz$)

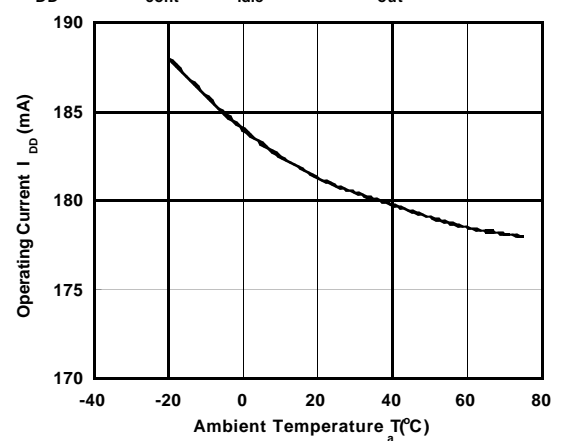

Gain vs. PHS Band Frequency vs. Control Voltage

($V_{DD}=3.0V$, $I_{DD}=180mA$, $T_a=25^\circ C$)

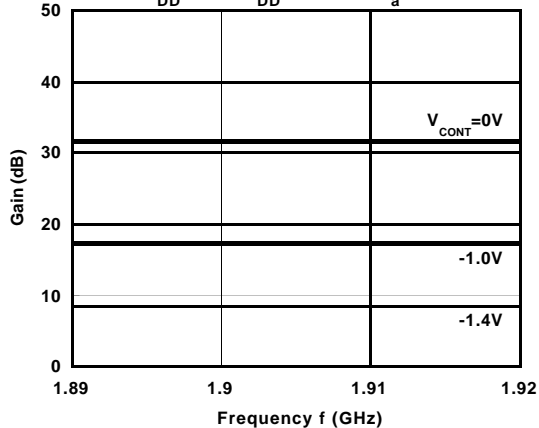

Gain, Operating Current vs. V_{DD}

($V_{cont}=0V$, $I_{idle}=180mA$ @ $V_{DD}=3.6V$, $P_{out}=21dBm$, $f=1.9GHz$, $T_a=25^\circ C$)

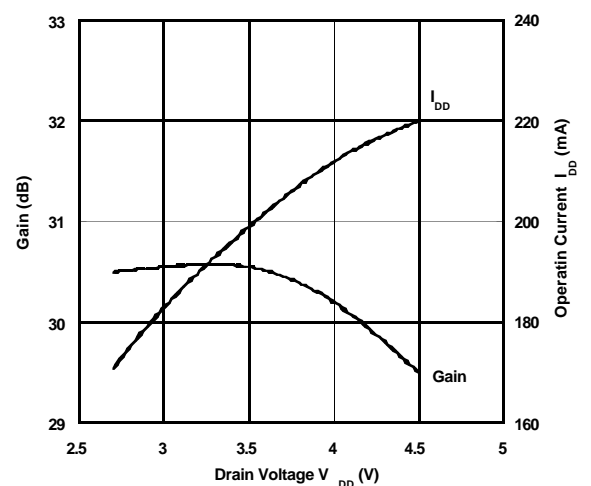

TYPICAL CHARACTERISTICS

Output Power, Total Current vs. Input Power

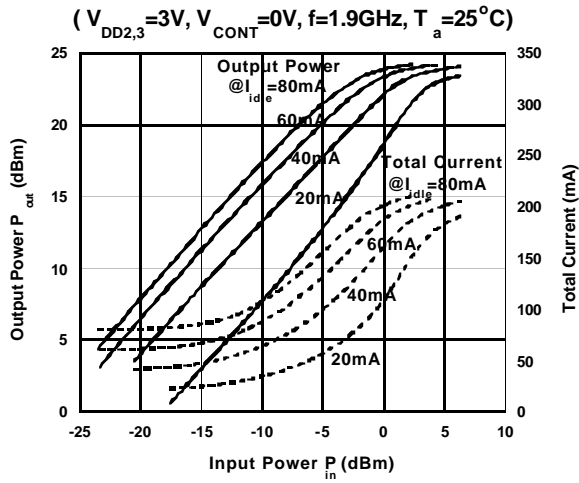

Output Power, P.A.E. vs. Input Power

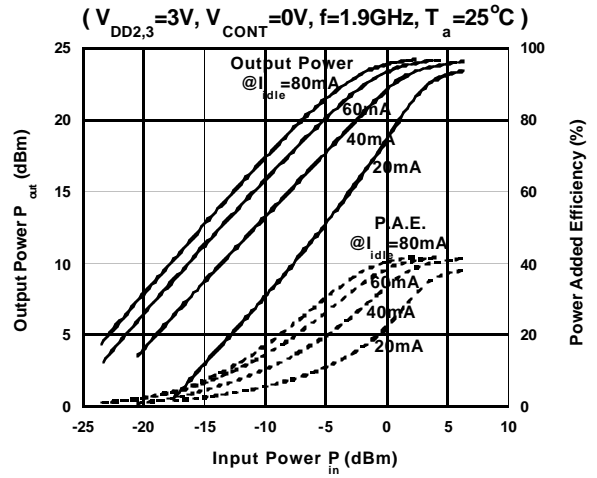

$|S_{11}|, |S_{22}|$ vs. Frequency

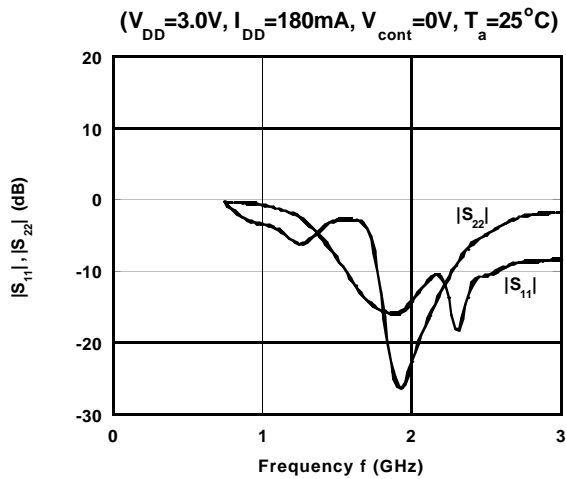

Harmonic Spectrum

(Suppressed Level for Fundamental Signal Level)
 ($P_{out}=21dBm, V_{DD}=3.0V, V_{cont}=0V, I_{idle}=180mA, T_a=25^\circ C$)

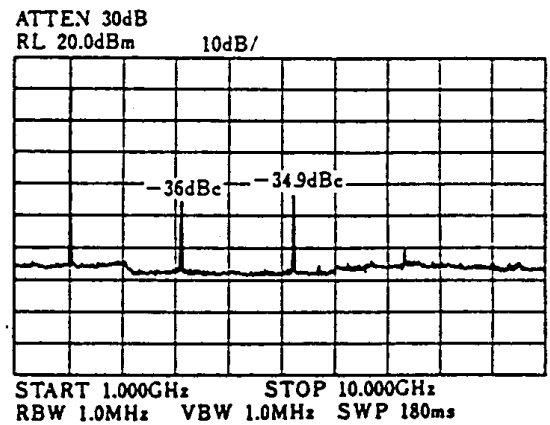

Output Spectrum

($V_{DD}=3.0V, I_{idle}=180mA, P_{out}=21dBm, V_{cont}=0V, T_a=25^\circ C$)

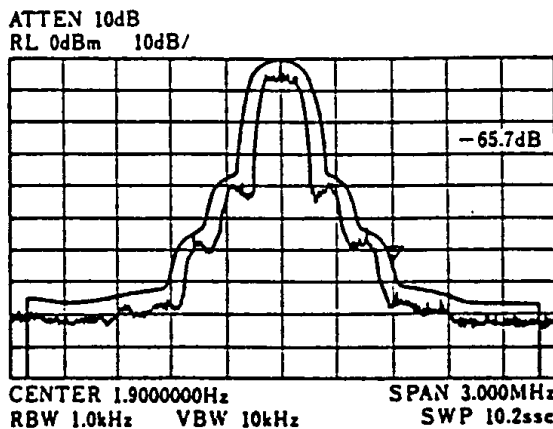

All adjacent channel leakage power used in these evaluations are those of 600kHz offset from fundamental wave at PHS operating condition(? /4QPSK modulation)

NJG1302V

RECOMMENDED CIRCUIT

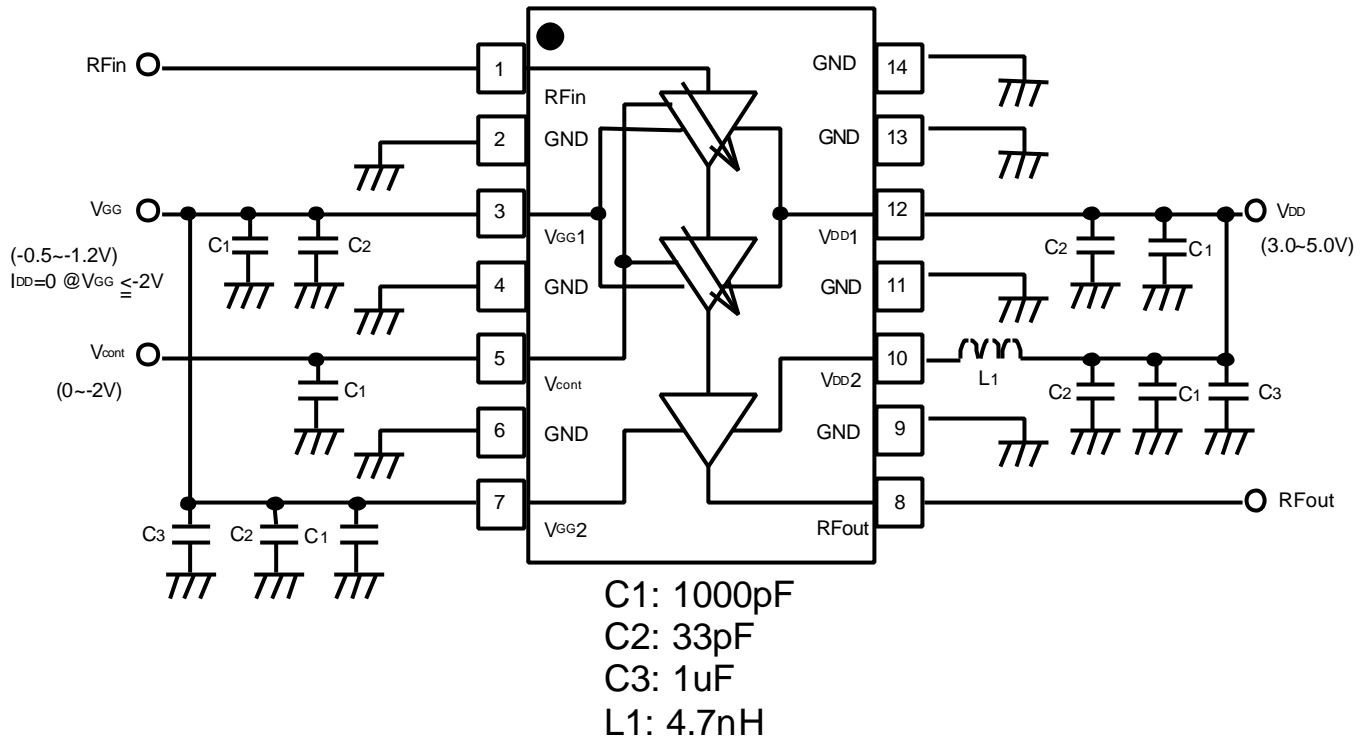

RECOMMENDED PCB DESIGN

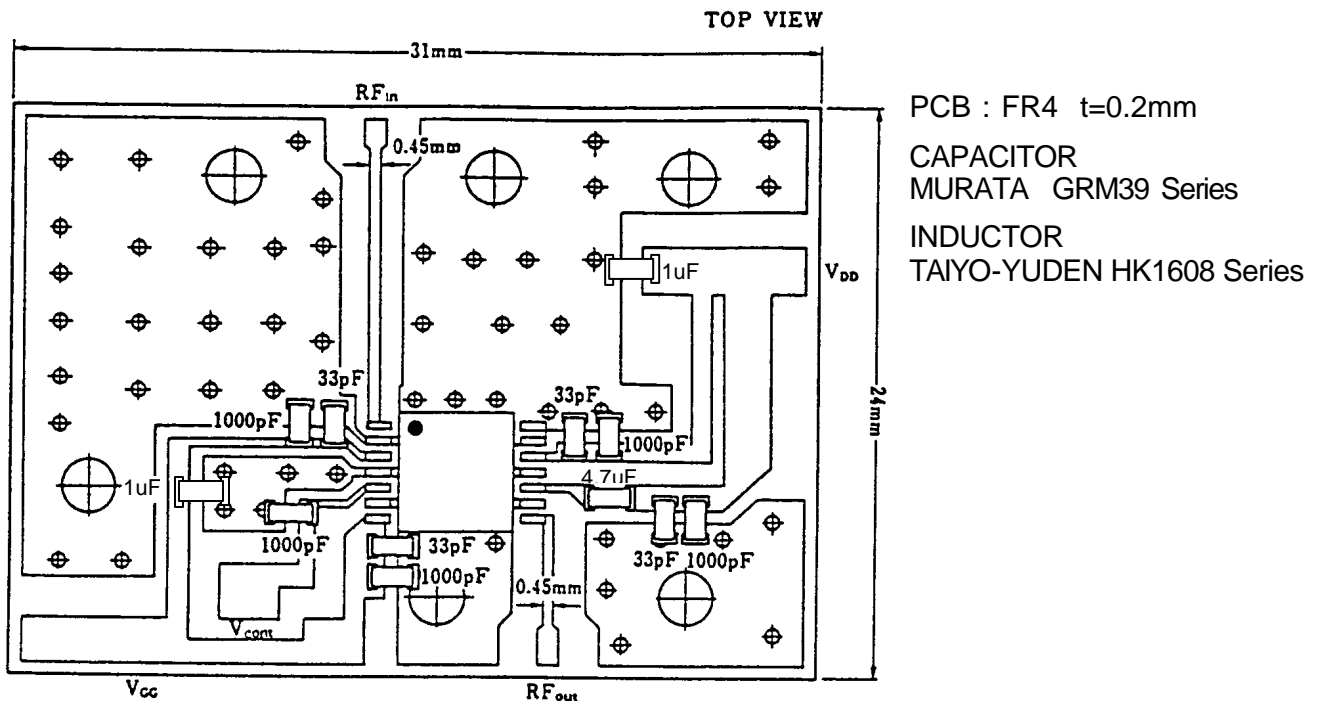

The reflow method is recommended for this device to attach on PCB

APPLICATION CIRCUIT (NEGATIVE VOLTAGE GENERATOR)

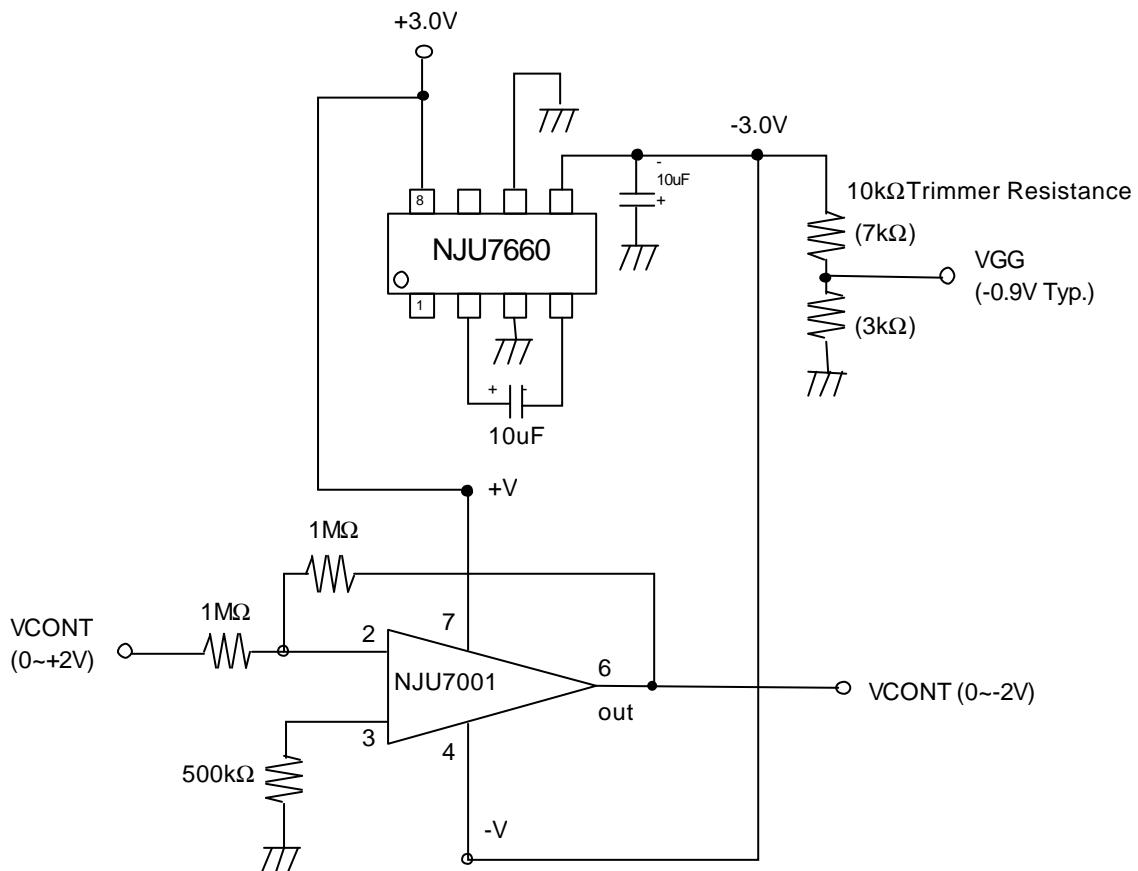

NJG1302V

■PACKAGE OUTLINE (SSOP14)

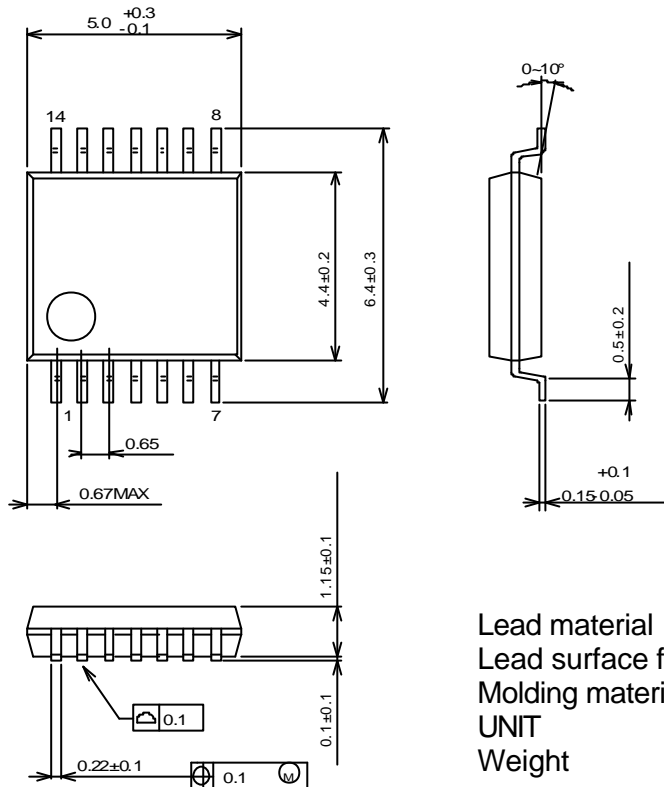

Lead material	: Copper
Lead surface finish	: Solder plating
Molding material	: Epoxy resin
UNIT	: mm
Weight	: 66mg

Cautions on using this product

This product contains Gallium-Arsenide (GaAs) which is a harmful material.

- Do NOT eat or put into mouth.
- Do NOT dispose in fire or break up this product.
- Do NOT chemically make gas or powder with this product.
- To waste this product, please obey the relating law of your country.

[CAUTION]

The specifications on this databook are only given for information, without any guarantee as regards either mistakes or omissions. The application circuits in this databook are described only to show representative usages of the product and not intended for the guarantee or permission of any right including the industrial rights.

This product may be damaged with electric static discharge (ESD) or spike voltage. Please handle with care to avoid these damages.