



**TISP7070H3SL THRU TISP7095H3SL,
TISP7125H3SL THRU TISP7220H3SL,
TISP7250H3SL THRU TISP7400H3SL**

**TRIPLE ELEMENT BIDIRECTIONAL THYRISTOR
OVERVOLTAGE PROTECTORS**

TISP7xxxH3SL Overvoltage Protector Series

TISP7xxxH3SL Overview

This TISP[®] device series protects central office, access and customer premise equipment against overvoltages on the telecom line. The TISP7xxxH3SL has the same symmetrical bidirectional protection on any terminal pair; R-T, R-G and T-G. In addition, the device is rated for simultaneous R-G and T-G impulse conditions. The TISP7xxxH3SL is available in a wide range of voltages and has a high current capability, allowing minimal series resistance to be used. These protectors have been specified mindful of the following standards and recommendations: GR-1089-CORE, FCC Part 68, UL1950, EN 60950, IEC 60950, ITU-T K.20, K.21 and K.45. The TISP7350H3SL meets the FCC Part 68 "B" ringer voltage requirement and survives both Type A and B impulse tests. These devices are housed in a through-hole 3-pin single-in-line (SL) plastic package.

Summary Electrical Characteristics

Part #	V _{DRM} V	V _(BO) V	V _T @ I _T V	I _{DRM} μA	I _(BO) mA	I _T A	I _H mA	C _o @ -2 V pF	Functionally Replaces
TISP7070H3	58	70	3	5	600	5	150	140	
TISP7080H3	65	80	3	5	600	5	150	140	
TISP7095H3	75	95	3	5	600	5	150	140	
TISP7125H3	100	125	3	5	600	5	150	74	
TISP7135H3	110	135	3	5	600	5	150	74	
TISP7145H3	120	145	3	5	600	5	150	74	
TISP7165H3	130	165	3	5	600	5	150	74	P1553AC†
TISP7180H3	145	180	3	5	600	5	150	74	
TISP7200H3	150	200	3	5	600	5	150	74	P1803AC†
TISP7210H3	160	210	3	5	600	5	150	74	
TISP7220H3	170	220	3	5	600	5	150	74	P2103AC†
TISP7250H3	200	250	3	5	600	5	150	62	P2353AC†
TISP7290H3	230	290	3	5	600	5	150	62	P2703AC†
TISP7300H3	230	300	3	5	600	5	150	62	
TISP7350H3	275	350	3	5	600	5	150	62	P3203AC
TISP7400H3	300	400	3	5	600	5	150	62	P3403AC

† Bourns' part has an improved protection voltage

Summary Current Ratings

Parameter	I _{TSP} A						I _{TSM} A	di/dt A/μs
	2/10	1.2/50, 8/20	10/160	5/320	10/560	10/1000		
Waveshape	2/10	1.2/50, 8/20	10/160	5/320	10/560	10/1000	1 cycle 60 Hz	2/10 Wavefront
Value	500	350	250	200	130	100	60	400

*RoHS Directive 2002/95/EC Jan 27 2003 including Annex
MARCH 1999 - REVISED FEBRUARY 2005
Specifications are subject to change without notice.
Customers should verify actual device performance in their specific applications.

TISP7xxxH3SL Overvoltage Protector Series



ITU-T K.20/21 Rating 8 kV 10/700, 200 A 5/310

Ion-Implanted Breakdown Region
Precise and Stable Voltage
Low Voltage Overshoot under Surge

Device	V _{DRM} V	V _(BO) V
'7070	58	70
'7080	65	80
'7095	75	95
'7125	100	125
'7135	110	135
'7145	120	145
'7165	130	165
'7180	145	180
'7200	150	200
'7210	160	210
'7220	170	220
'7250	200	250
'7290	230	290
'7350	275	350
'7400	300	400

Rated for International Surge Wave Shapes
- Single and Simultaneous Impulses

Waveshape	Standard	I _{TSP} A
2/10 μs	GR-1089-CORE	500
8/20 μs	IEC 61000-4-5	350
10/160 μs	FCC Part 68	250
10/700 μs	FCC Part 68 ITU-T K.20/21	200
10/560 μs	FCC Part 68	130
10/1000 μs	GR-1089-CORE	100

SL Package (Top View)

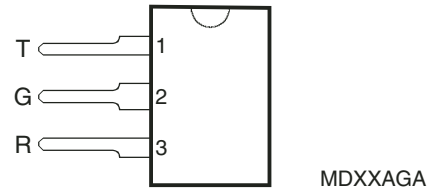

Device Symbol

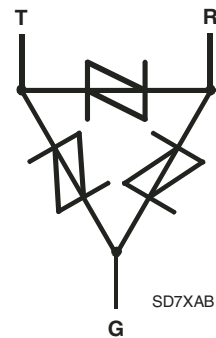

Terminals T, R and G correspond to the alternative line designators of A, B and C

3-Pin Through-Hole Packaging
- Compatible with TO-220AB pin-out

-Low Height 8.3 mm

Low Differential Capacitance < 72 pF

..... UL Recognized Component

Description

The TISP7xxxH3SL limits overvoltages between the telephone line Ring and Tip conductors and Ground. Overvoltages are normally caused by a.c. power system or lightning flash disturbances which are induced or conducted on to the telephone line.

Each terminal pair, T-G, R-G and T-R, has a symmetrical voltage-triggered bidirectional thyristor protection characteristic. Overvoltages are initially clipped by breakdown clamping until the voltage rises to the breakover level, which causes the device to crowbar into a low-voltage on state. This low-voltage on state causes the current resulting from the overvoltage to be safely diverted through the device. The high crowbar holding current prevents d.c. latchup as the diverted current subsides.

How To Order

Device	Package	Carrier	For Standard Termination Finish Order As	For Lead Free Termination Finish Order As
TISP7xxxH3	SL (Single-in-Line)	Tube	TISP7xxxH3SL	TISP7xxxH3SL-S

Insert xxx value corresponding to protection voltages of 070, 080, 095, 125 etc.

TISP7xxxH3SL Overvoltage Protector Series

BOURNS®

Description (continued)

This TISP7xxxH3SL range consists of fifteen voltage variants to meet various maximum system voltage levels (58 V to 300 V). They are guaranteed to voltage limit and withstand the listed international lightning surges in both polarities. These high current protection devices are in a 3-pin single-in-line (SL) plastic package and are supplied in tube pack. For alternative impulse rating, voltage and holding current values in SL packaged protectors, consult the factory. For lower rated impulse currents in the SL package, the 45 A 10/1000 TISP7xxxF3SL series is available.

These monolithic protection devices are fabricated in ion-implanted planar structures to ensure precise and matched breakover control and are virtually transparent to the system in normal operation.

Absolute Maximum Ratings, $T_A = 25^\circ\text{C}$ (Unless Otherwise Noted)

Rating	Symbol	Value	Unit
Repetitive peak off-state voltage, (see Note 1)	'7070	± 58	V
	'7080	± 65	
	'7095	± 75	
	'7125	± 100	
	'7135	± 110	
	'7145	± 120	
	'7165	± 130	
	'7180	± 145	
	'7200	± 150	
	'7210	± 160	
	'7220	± 170	
	'7250	± 200	
	'7290	± 230	
	'7350	± 275	
	'7400	± 300	
Non-repetitive peak on-state pulse current (see Notes 2, and 3)	I_{TSP}	500	A
2/10 (Telcordia GR-1089-CORE, 2/10 voltage wave shape)		350	
8/20 μs (IEC 61000-4-5, 1.2/50 μs voltage, 8/20 current combination wave generator)		250	
10/160 μs (FCC Part 68, 10/160 μs voltage wave shape)		225	
4/250 (ITU-T K.20/21, 10/700 voltage wave shape, dual)		200	
0.2/310 (CNET I 31-24, 0.5/700 voltage wave shape)		200	
5/310 (ITU-T K.20/21, 10/700 voltage wave shape, single)		200	
5/320 μs (FCC Part 68, 9/720 μs voltage wave shape)		130	
10/560 μs (FCC Part 68, 10/560 μs voltage wave shape)		100	
10/1000 (Telcordia GR-1089-CORE, 10/1000 voltage wave shape)			
Non-repetitive peak on-state current (see Notes 2, 3 and 4)	I_{TSM}	55	A
20 ms (50 Hz) full sine wave		60	
16.7 ms (60 Hz) full sine wave		0.9	
1000 s 50 Hz/60 Hz a.c.			
Initial rate of rise of on-state current, Exponential current ramp, Maximum ramp value < 200 A	di_T/dt	400	A/ μs
Junction temperature	T_J	-40 to +150	$^\circ\text{C}$
Storage temperature range	T_{stg}	-65 to +150	$^\circ\text{C}$

- NOTES: 1. Derate value at $-0.13\%/^\circ\text{C}$ for temperatures below 25°C .
 2. Initially the TISP7xxxH3 must be in thermal equilibrium.
 3. These non-repetitive rated currents are peak values of either polarity. The rated current values may be applied to any terminal pair. Additionally, both R and T terminals may have their rated current values applied simultaneously (in this case the G terminal return current will be the sum of the currents applied to the R and T terminals). The surge may be repeated after the TISP7xxxH3 returns to its initial conditions.
 4. EIA/JESD51-2 environment and EIA/JESD51-3 PCB with standard footprint dimensions connected with 5 A rated printed wiring track widths. Derate current values at $-0.61\%/^\circ\text{C}$ for ambient temperatures above 25°C .

TISP7xxxH3SL Overvoltage Protector Series

BOURNS®

Electrical Characteristics for any Terminal Pair, $T_A = 25\text{ }^\circ\text{C}$ (Unless Otherwise Noted)

Parameter	Test Conditions	Min	Typ	Max	Unit	
I_{DRM} Repetitive peak off-state current	$V_D = V_{\text{DRM}}$ $T_A = 25\text{ }^\circ\text{C}$ $T_A = 85\text{ }^\circ\text{C}$			± 5 ± 10	μA	
$V_{(\text{BO})}$ Breakover voltage	$dv/dt = \pm 750\text{ V/ms}$, $R_{\text{SOURCE}} = 300\ \Omega$			'7070 '7080 '7095 '7125 '7135 '7145 '7165 '7180 '7200 '7210 '7220 '7250 '7290 '7350 '7400	± 70 ± 80 ± 95 ± 125 ± 135 ± 145 ± 165 ± 180 ± 200 ± 210 ± 220 ± 250 ± 290 ± 350 ± 400	V
$V_{(\text{BO})}$ Impulse breakover voltage	$dv/dt \leq \pm 1000\text{ V}/\mu\text{s}$, Linear voltage ramp, Maximum ramp value = $\pm 500\text{ V}$ $di/dt = \pm 20\text{ A}/\mu\text{s}$, Linear current ramp, Maximum ramp value = $\pm 10\text{ A}$			'7070 '7080 '7095 '7125 '7135 '7145 '7165 '7180 '7200 '7210 '7220 '7250 '7290 '7350 '7400	± 78 ± 88 ± 103 ± 134 ± 144 ± 154 ± 174 ± 189 ± 210 ± 220 ± 231 ± 261 ± 302 ± 362 ± 414	V
$I_{(\text{BO})}$ Breakover current	$dv/dt = \pm 750\text{ V/ms}$, $R_{\text{SOURCE}} = 300\ \Omega$	± 0.1		± 0.8	A	
V_T On-state voltage	$I_T = \pm 5\text{ A}$, $t_W = 100\ \mu\text{s}$			± 5	V	
I_H Holding current	$I_T = \pm 5\text{ A}$, $di/dt = -/+30\text{ mA/ms}$	± 0.15		± 0.6	A	
dv/dt Critical rate of rise of off-state voltage	Linear voltage ramp, Maximum ramp value $< 0.85V_{\text{DRM}}$	± 5			$\text{kV}/\mu\text{s}$	
I_D Off-state current	$V_D = \pm 50\text{ V}$ $T_A = 85\text{ }^\circ\text{C}$			± 10	μA	

TISP7xxxH3SL Overvoltage Protector Series

BOURNS®

Electrical Characteristics for any Terminal Pair, $T_A = 25\text{ }^\circ\text{C}$ (Unless Otherwise Noted)

A

Parameter	Test Conditions	Min	Typ	Max	Unit
C_{off} Off-state capacitance	$f = 1\text{ MHz}, V_d = 1\text{ V rms}, V_D = 0,$	'7070 thru '7095		170	pF
		'7125 thru '7220		90	
		'7250 thru '7400		84	
	$f = 1\text{ MHz}, V_d = 1\text{ V rms}, V_D = -1\text{ V}$	'7070 thru '7095		150	
		'7125 thru '7220		79	
		'7250 thru '7400		67	
	$f = 1\text{ MHz}, V_d = 1\text{ V rms}, V_D = -2\text{ V}$	'7070 thru '7095		140	
		'7125 thru '7220		74	
		'7250 thru '7400		62	
	$f = 1\text{ MHz}, V_d = 1\text{ V rms}, V_D = -50\text{ V}$	'7070 thru '7095		73	
		'7125 thru '7220		35	
		'7250 thru '7400		28	
$f = 1\text{ MHz}, V_d = 1\text{ V rms}, V_D = -100\text{ V}$ (see Note 5)	'7125 thru '7220		33		
	'7250 thru '7400		26		

NOTE 5: To avoid possible voltage clipping, the '7125 is tested with $V_D = -98\text{ V}$.

Thermal Characteristics

Parameter	Test Conditions	Min	Typ	Max	Unit
$R_{\theta JA}$ Junction to free air thermal resistance	EIA/JESD51-3 PCB, $I_T = I_{TSM(1000)}$, $T_A = 25\text{ }^\circ\text{C}$, (see Note 6)			50	$^\circ\text{C/W}$

NOTE 6: EIA/JESD51-2 environment and PCB has standard footprint dimensions connected with 5 A rated printed wiring track widths.

Parameter Measurement Information

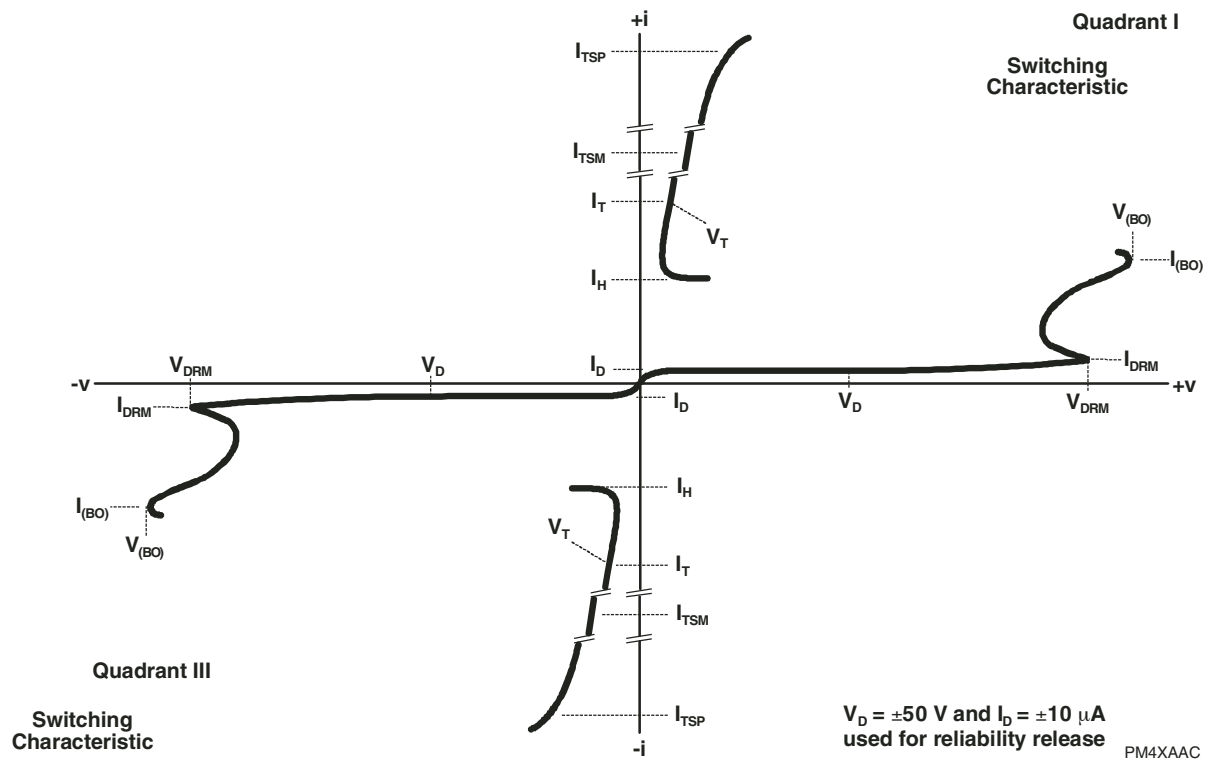

Figure 1. Voltage-current Characteristic for Terminal Pairs

Typical Characteristics

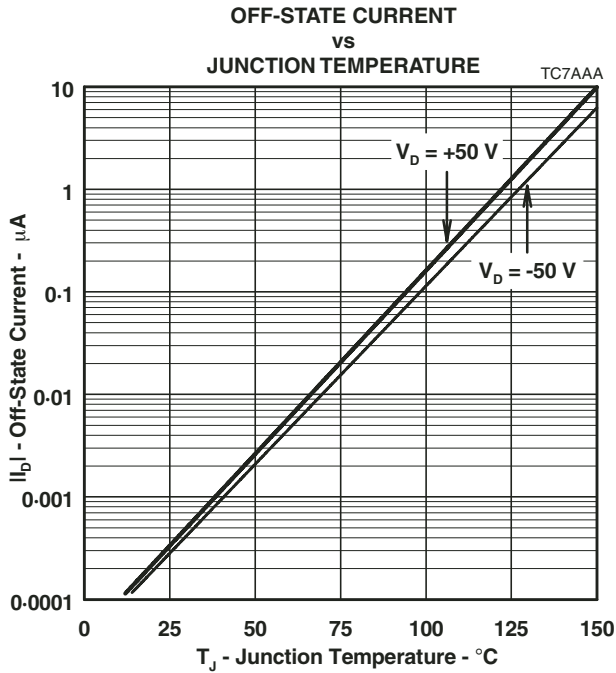

Figure 2.

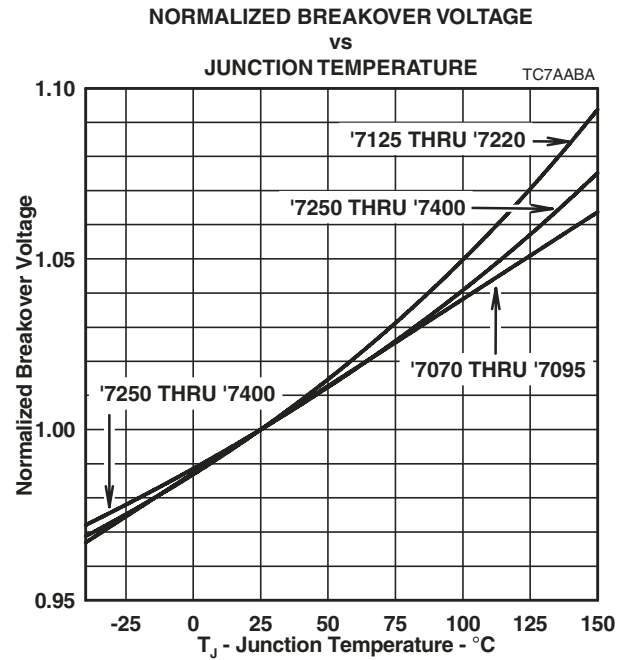

Figure 3.

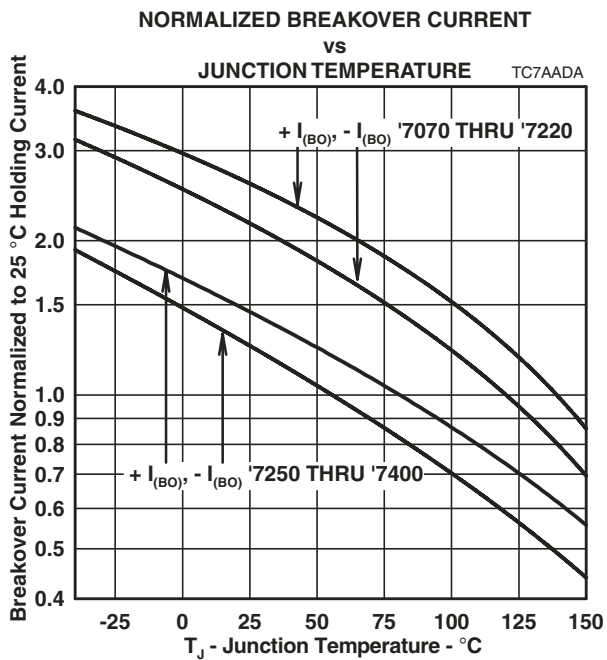

Figure 4.

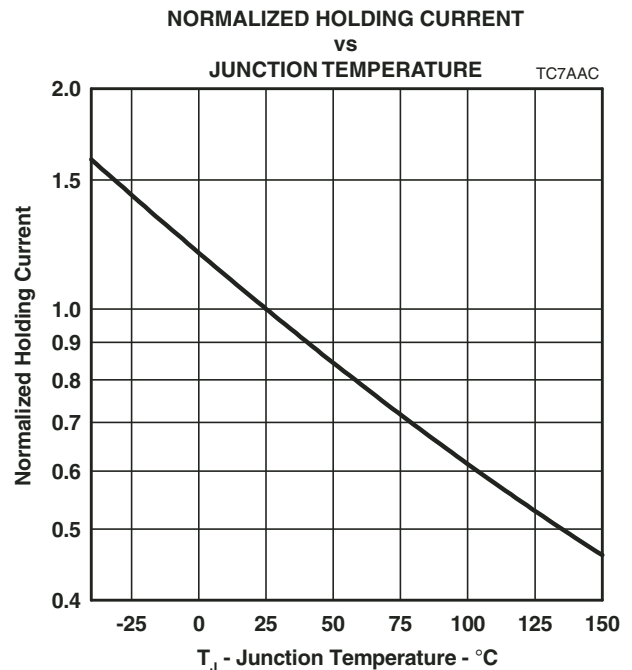

Figure 5.

Typical Characteristics

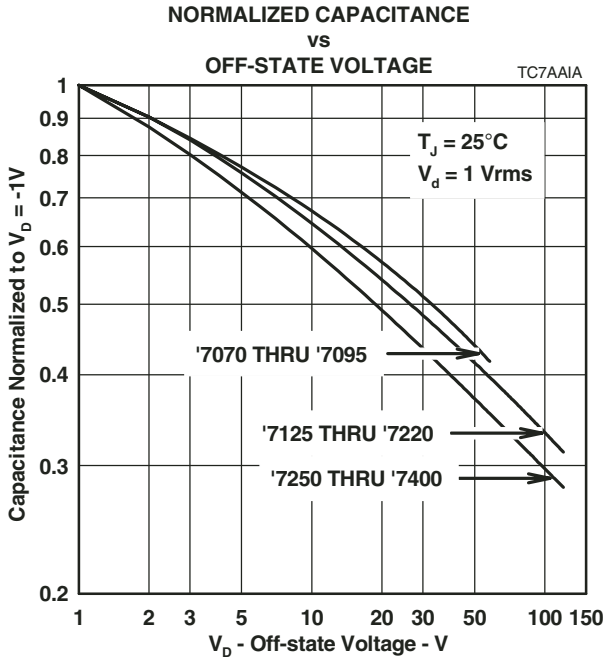

Figure 6.

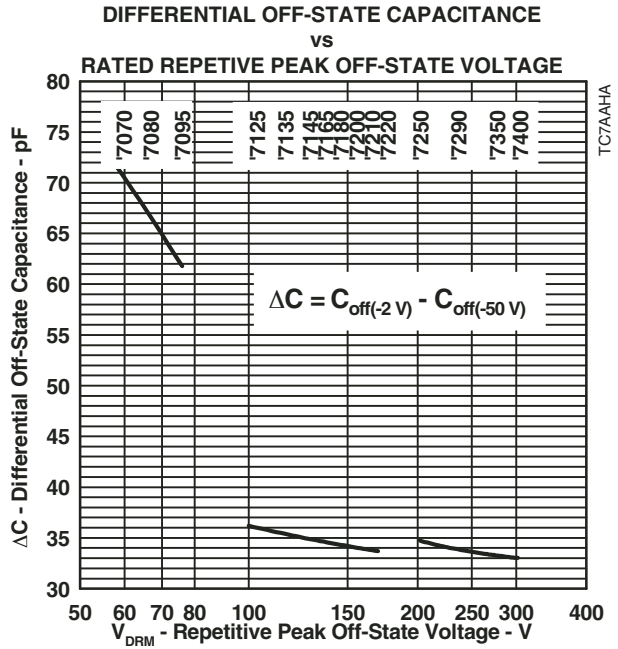

Figure 7.

Rating and Thermal Information

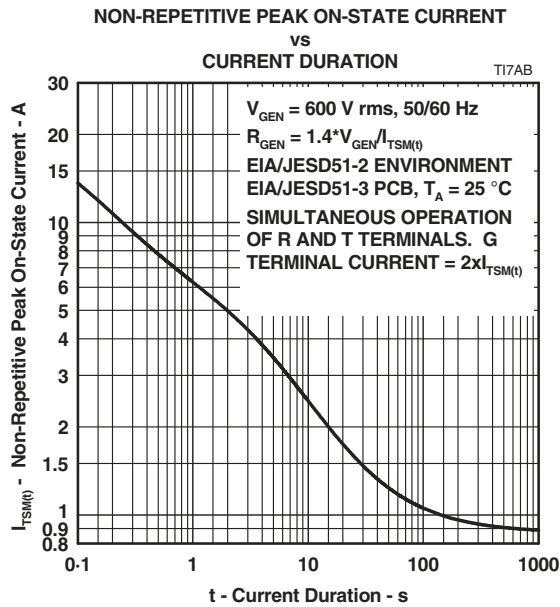

Figure 8.

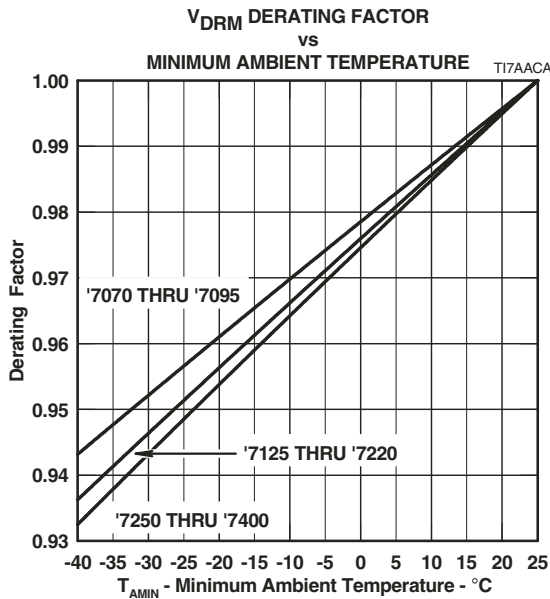

Figure 9.

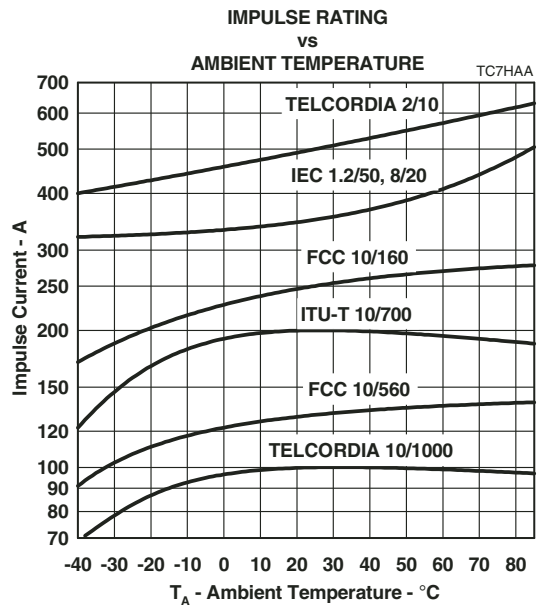

Figure 10.

APPLICATIONS INFORMATION

Deployment

These devices are three terminal overvoltage protectors. They limit the voltage between three points in the circuit. Typically, this would be the two line conductors and protective ground (Figure 11).

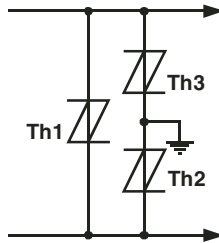

Figure 11. MULTI-POINT PROTECTION

In Figure 11, protectors Th2 and Th3 limit the maximum voltage between each conductor and ground to the $\pm V_{(BO)}$ of the individual protector. Protector Th1 limits the maximum voltage between the two conductors to its $\pm V_{(BO)}$ value.

Manufacturers are being increasingly required to design in protection coordination. This means that each protector is operated at its design level and currents are diverted through the appropriate protector, e.g. the primary level current through the primary protector and lower levels of current may be diverted through the secondary or inherent equipment protection. Without coordination, primary level currents could pass through the equipment only designed to pass secondary level currents. To ensure coordination happens with fixed voltage protectors, some resistance is normally used between the primary and secondary protection. The values given in this data sheet apply to a 400 V (d.c. sparkover) gas discharge tube primary protector and the appropriate test voltage when the equipment is tested with a primary protector.

Impulse Testing

To verify the withstand capability and safety of the equipment, standards require that the equipment is tested with various impulse wave forms. The table below shows some common values.

Standard	Peak Voltage Setting V	Voltage Waveform μs	Peak Current Value A	Current Waveform μs	TISP7xxxH3 25 °C Rating A	Series Resistance Ω	Coordination Resistance (Min.)
GR-1089-CORE	2500	2/10	500	2/10	500	0	NA
	1000	10/1000	100	10/1000	100		
FCC Part 68 (March 1998)	1500	10/160	200	10/160	250	0	NA
	800	10/560	100	10/560	130		
	1000	9/720 †	25	5/320 †	200		
	1500	(SINGLE)	37.5	5/320 †	200		
	1500	(DUAL)	2 x 27	4/250	2 x 225		
I 31-24	1500	0.5/700	37.5	0.2/310	200	0	NA
ITU-T K.20/K.21	1000	10/700	25	5/310	200	0	NA
	1500	(SINGLE)	37.5	5/310	200		NA
	4000	(SINGLE)	100	5/310	200		4.5
	4000	(DUAL)	2 x 72	4/250	2 x 225		6.0

† FCC Part 68 terminology for the waveforms produced by the ITU-T recommendation K.21 10/700 impulse generator

NA = Not Applicable, primary protection removed or not specified.

If the impulse generator current exceeds the protector's current rating, then a series resistance can be used to reduce the current to the protector's rated value to prevent possible failure. The required value of series resistance for a given waveform is given by the following calculations. First, the minimum total circuit impedance is found by dividing the impulse generator's peak voltage by the protector's rated current. The impulse generator's fictive impedance (generator's peak voltage divided by peak short circuit current) is then subtracted from the minimum total circuit impedance to give the required value of series resistance. In some cases, the equipment will require verification over a temperature range. By using the rated waveform values from Figure 10, the appropriate series resistor value can be calculated for ambient temperatures in the range of -40 °C to 85 °C.

APPLICATIONS INFORMATION

AC Power Testing

The protector can withstand the G return currents applied for times not exceeding those shown in Figure 8. Currents that exceed these times must be terminated or reduced to avoid protector failure. Fuses, PTC (Positive Temperature Coefficient) resistors and fusible resistors are overcurrent protection devices which can be used to reduce the current flow. Protective fuses may range from a few hundred milliamperes to one ampere. In some cases, it may be necessary to add some extra series resistance to prevent the fuse opening during impulse testing. The current versus time characteristic of the overcurrent protector must be below the line shown in Figure 8. In some cases there may be a further time limit imposed by the test standard (e.g. UL 1459 wiring simulator failure).

Capacitance

The protector characteristic off-state capacitance values are given for d.c. bias voltage, V_D , values of 0, -1 V, -2 V and -50 V. Where possible, values are also given for -100 V. Values for other voltages may be calculated by multiplying the $V_D = 0$ capacitance value by the factor given in Figure 6. Up to 10 MHz, the capacitance is essentially independent of frequency. Above 10 MHz, the effective capacitance is strongly dependent on connection inductance. For example, a printed wiring (PW) trace of 10 cm could create a circuit resonance with the device capacitance in the region of 50 MHz. In many applications, the typical conductor bias voltages will be about -2 V and -50 V. Figure 7 shows the differential (line unbalance) capacitance caused by biasing one protector at -2 V and the other at -50 V.

Normal System Voltage Levels

The protector should not clip or limit the voltages that occur in normal system operation. For unusual conditions, such as ringing without the line connected, some degree of clipping is permissible. Under this condition, about 10 V of clipping is normally possible without activating the ring trip circuit.

Figure 9 allows the calculation of the protector V_{DRM} value at temperatures below 25 °C. The calculated value should not be less than the maximum normal system voltages. The TISP7290H3, with a V_{DRM} of 230 V, can be used for the protection of ring generators producing 105 V rms of ring on a battery voltage of -58 V. The peak ring voltage will be $58 + 1.414 \times 105 = 206.5$ V. However, this is the open circuit voltage and the connection of the line and its equipment will reduce the peak voltage.

For the extreme case of an unconnected line, the temperature at which clipping begins can be calculated using the data from Figure 9. To possibly clip, the V_{DRM} value has to be 206.5 V. This is a reduction of the 230 V 25 °C V_{DRM} value by a factor of $206.5/230 = 0.90$. Figure 9 shows that a 0.90 reduction will occur below an ambient temperature of -40 °C. For this example, the TISP7290H3 will allow normal equipment operation, even on an open-circuit line, down to below -40 °C.

JESD51 Thermal Measurement Method

To standardize thermal measurements, the EIA (Electronic Industries Alliance) has created the JESD51 standard. Part 2 of the standard (JESD51-2, 1995) describes the test environment. This is a 0.0283 m^3 (1 ft³) cube which contains the test PCB (Printed Circuit Board) horizontally mounted at the center. Part 3 of the standard (JESD51-3, 1996) defines two test PCBs for surface mount components; one for packages smaller than 27 mm (1.06 ") on a side and the other for packages up to 48 mm (1.89 "). The thermal measurements used the smaller 76.2 mm x 114.3 mm (3.0 " x 4.5 ") PCB. The JESD51-3 PCBs are designed to have low effective thermal conductivity (high thermal resistance) and represent a worse case condition. The PCBs used in the majority of applications will achieve lower values of thermal resistance and so can dissipate higher power levels than indicated by the JESD51 values.

Typical Circuits

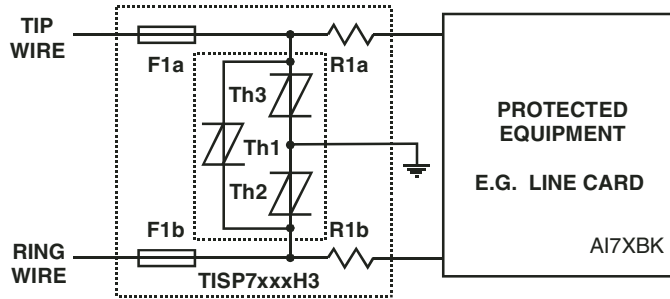

Figure 12. Protection Module

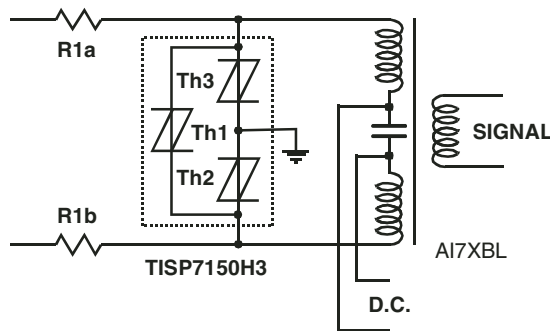

Figure 13. ISDN Protection

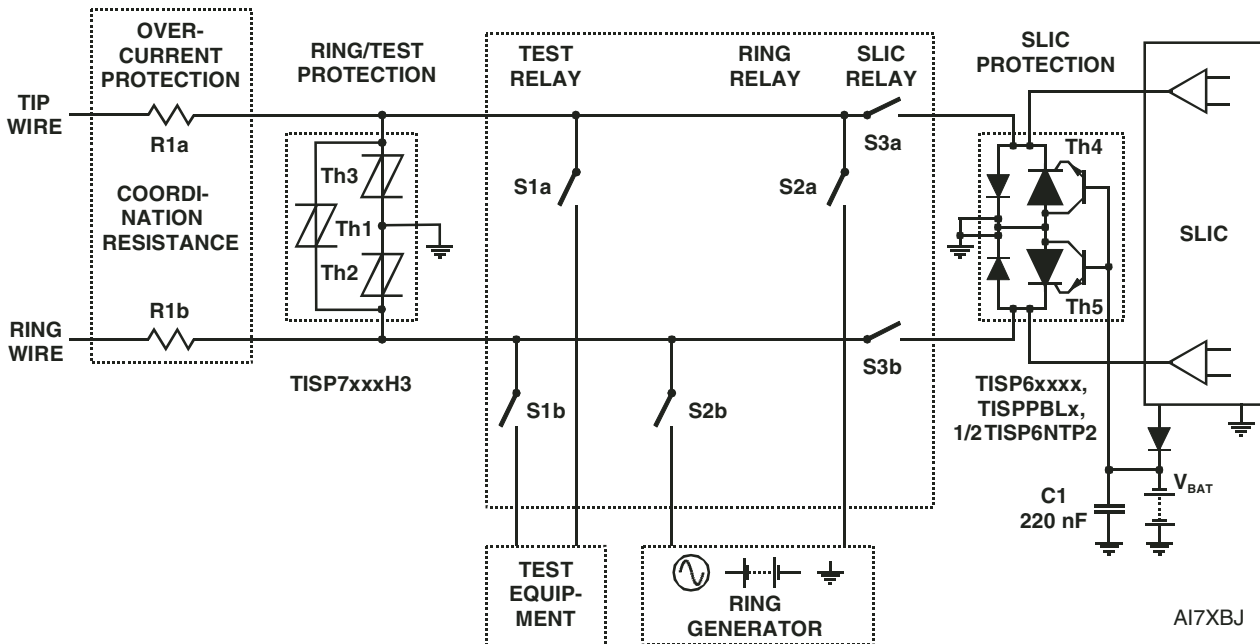
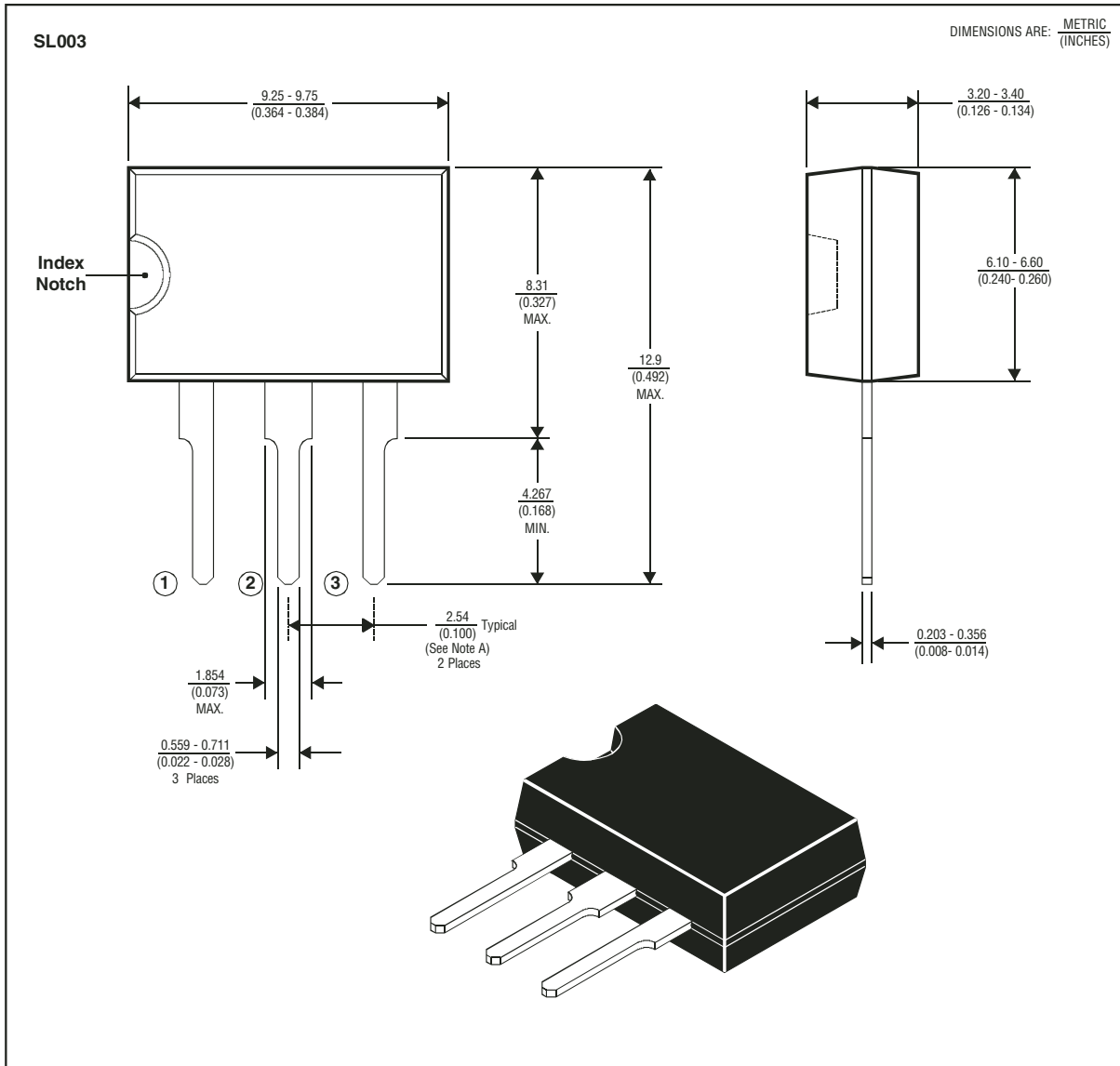

Figure 14. Line Card Ring/Test Protection

MECHANICAL DATA

SL003 3-pin Plastic Single-in-line Package

This single-in-line package consists of a circuit mounted on a lead frame and encapsulated within a plastic compound. The compound will withstand soldering temperature with no deformation, and circuit performance characteristics will remain stable when operated in high humidity conditions. Leads require no additional cleaning or processing when used in soldered assembly.



- NOTES: A. Each pin centerline is located within 0.25 (0.010) of its true longitudinal position.
B. Body molding flash of up to 0.15 (0.006) may occur in the package lead plane.

MDXXCE

"TISP" is a trademark of Bourns, Ltd., a Bourns Company, and is Registered in U.S. Patent and Trademark Office.
"Bourns" is a registered trademark of Bourns, Inc. in the U.S. and other countries.

MARCH 1999 - REVISED FEBRUARY 2005
Specifications are subject to change without notice.
Customers should verify actual device performance in their specific applications.