

**NPN Silicon High-Voltage Transistors**

- Suitable for video output stages in TV sets and switching power supplies
- High breakdown voltage
- Low collector-emitter saturation voltage
- Complementary types: BFN25, BFN27 (PNP)

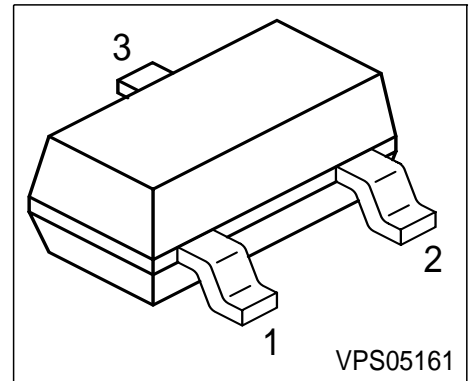

Type	Marking	Pin Configuration			Package
BFN24	FHs	1 = B	2 = E	3 = C	SOT23
BFN26	FJs	1 = B	2 = E	3 = C	SOT23

**Maximum Ratings**

Parameter	Symbol	BFN24	BFN26	Unit
Collector-emitter voltage	$V_{CEO}$	250	300	V
Collector-base voltage	$V_{CBO}$	250	300	
Emitter-base voltage	$V_{EBO}$	5	5	
DC collector current	$I_C$	200		mA
Peak collector current	$I_{CM}$	500		
Base current	$I_B$	100		
Peak base current	$I_{BM}$	200		
Total power dissipation, $T_S = 74\text{ °C}$	$P_{tot}$	360		mW
Junction temperature	$T_j$	150		°C
Storage temperature	$T_{stg}$	-65 ... 150		

**Thermal Resistance**

Junction - soldering point <sup>(1)</sup>	$R_{thJS}$	≤210	K/W
---	------------	------	-----

<sup>1</sup>For calculation of  $R_{thJA}$  please refer to Application Note Thermal Resistance

**Electrical Characteristics** at  $T_A = 25^\circ\text{C}$ , unless otherwise specified.

Parameter	Symbol	Values			Unit
		min.	typ.	max.	
<b>DC Characteristics</b>					
Collector-emitter breakdown voltage $I_C = 1 \text{ mA}, I_B = 0$	$V_{(BR)CEO}$				V
BFN24		250	-	-	
BFN26		300	-	-	
Collector-base breakdown voltage $I_C = 100 \mu\text{A}, I_E = 0$	$V_{(BR)CBO}$				
BFN24		250	-	-	
BFN26		300	-	-	
Emitter-base breakdown voltage $I_E = 100 \mu\text{A}, I_C = 0$	$V_{(BR)EBO}$	5	-	-	
Collector cutoff current $V_{CB} = 200 \text{ V}, I_E = 0$	$I_{CBO}$				nA
BFN24		-	-	100	
$V_{CB} = 250 \text{ V}, I_E = 0$	BFN26			100	
Collector cutoff current $V_{CB} = 200 \text{ V}, I_E = 0, T_A = 150^\circ\text{C}$	$I_{CBO}$				$\mu\text{A}$
BFN24		-	-	20	
$V_{CB} = 250 \text{ V}, I_E = 0, T_A = 150^\circ\text{C}$	BFN26			20	
Emitter cutoff current $V_{EB} = 3 \text{ V}, I_C = 0$	$I_{EBO}$	-	-	100	nA
DC current gain 1) $I_C = 1 \text{ mA}, V_{CE} = 10 \text{ V}$	$h_{FE}$	25	-	-	-
$I_C = 10 \text{ mA}, V_{CE} = 10 \text{ V}$		40	-	-	
$I_C = 30 \text{ mA}, V_{CE} = 10 \text{ V}$	BFN24	40	-	-	
	BFN26	30	-	-	
Collector-emitter saturation voltage1) $I_C = 20 \text{ mA}, I_B = 2 \text{ mA}$	$V_{CEsat}$				V
BFN24		-	-	0.4	
BFN26		-	-	0.5	
Base-emitter saturation voltage 1) $I_C = 20 \text{ mA}, I_B = 2 \text{ mA}$	$V_{BEsat}$	-	-	0.9	

 1) Pulse test:  $t < 300\mu\text{s}$ ;  $D < 2\%$

**Electrical Characteristics** at  $T_A = 25^\circ\text{C}$ , unless otherwise specified.

Parameter	Symbol	Values			Unit
		min.	typ.	max.	
<b>AC Characteristics</b>					
Transition frequency $I_C = 20\text{ mA}$ , $V_{CE} = 10\text{ V}$ , $f = 20\text{ MHz}$	$f_T$	-	70	-	MHz
Collector-base capacitance $V_{CB} = 30\text{ V}$ , $f = 1\text{ MHz}$	$C_{cb}$	-	1.5	-	pF

**Total power dissipation  $P_{tot} = f(T_S)$**

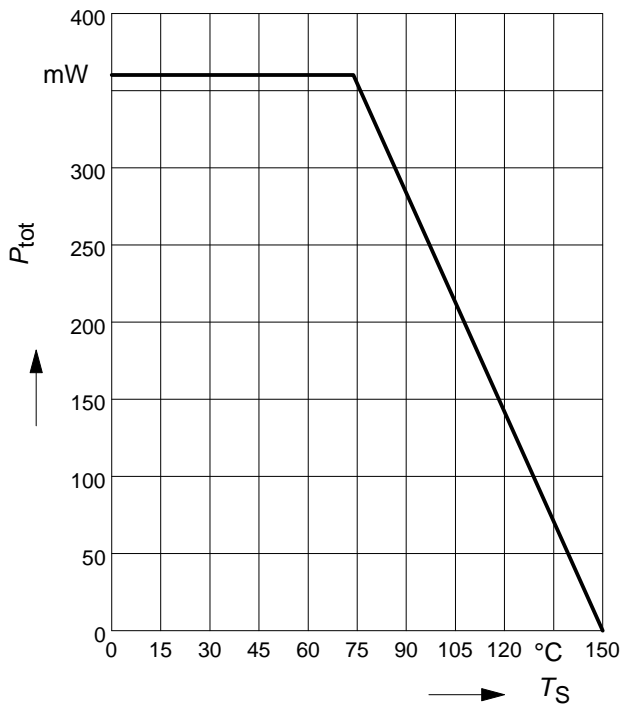

**Transition frequency  $f_T = f(I_C)$**

$V_{CE} = 10V$

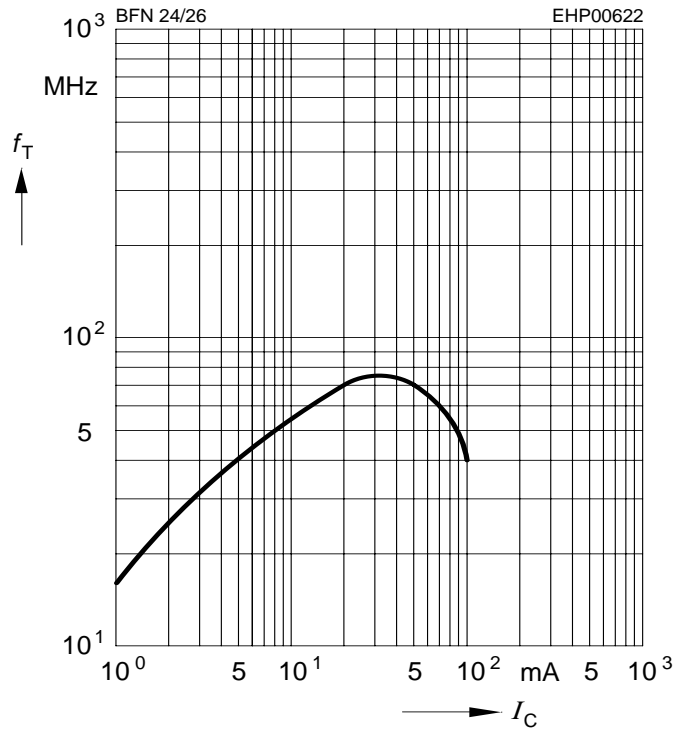

**Permissible pulse load**

$P_{totmax} / P_{totDC} = f(t_p)$

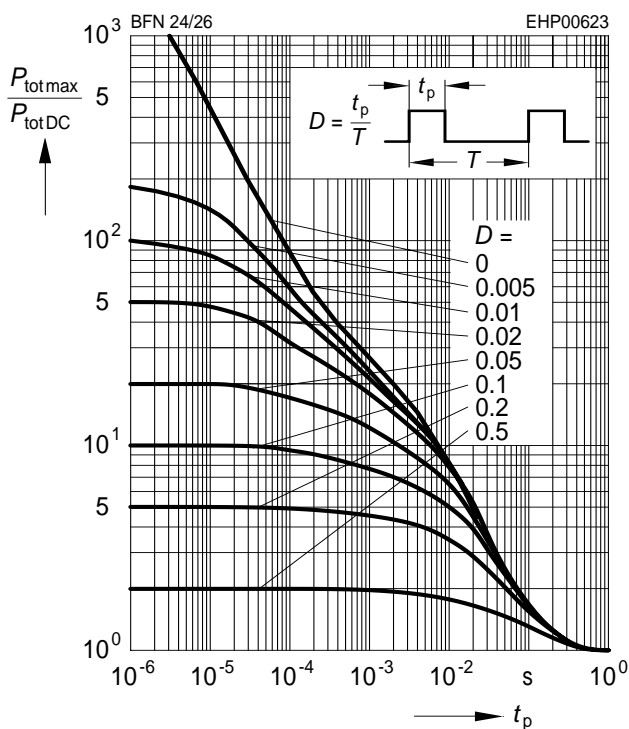

**Operating range  $I_C = f(V_{CE0})$**

$T_A = 25^\circ C, D = 0$

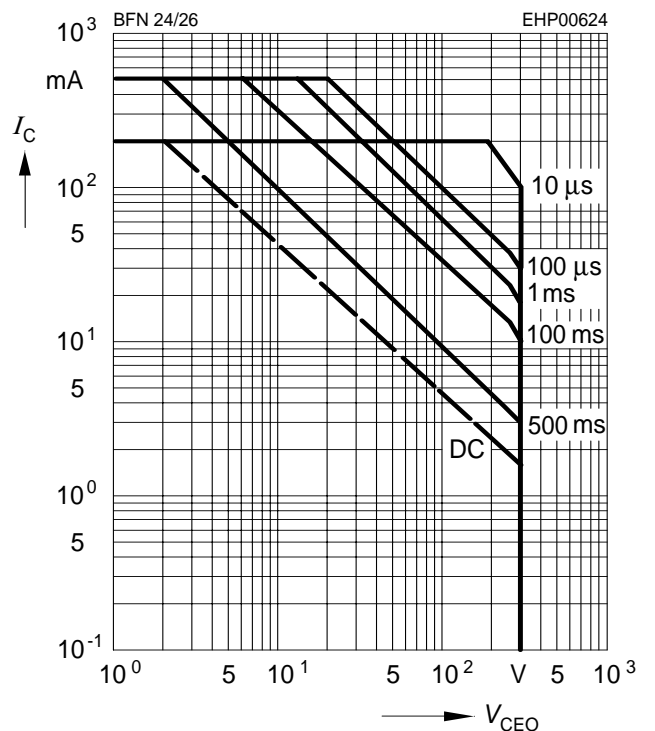

**Collector current  $I_C = f(V_{BE})$**

$V_{CE} = 10V$

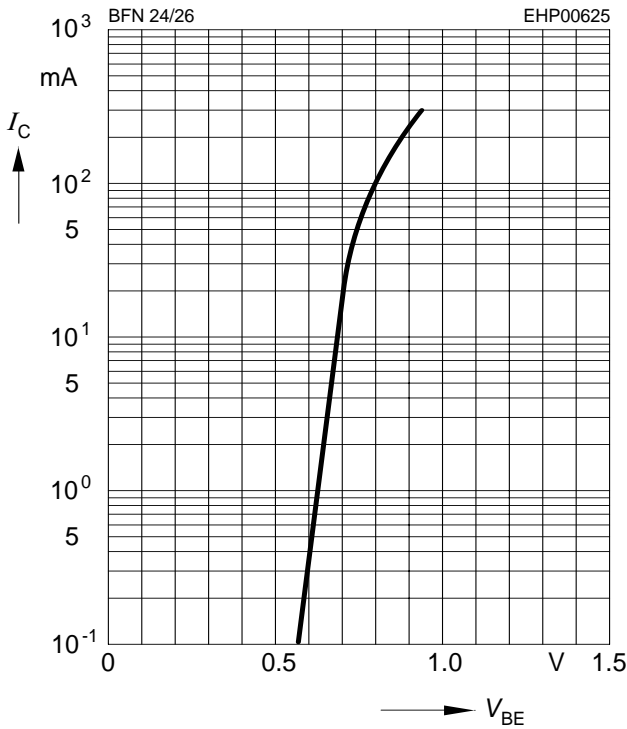

**Collector cutoff current  $I_{CBO} = f(T_A)$**

$V_{CB} = 200V$

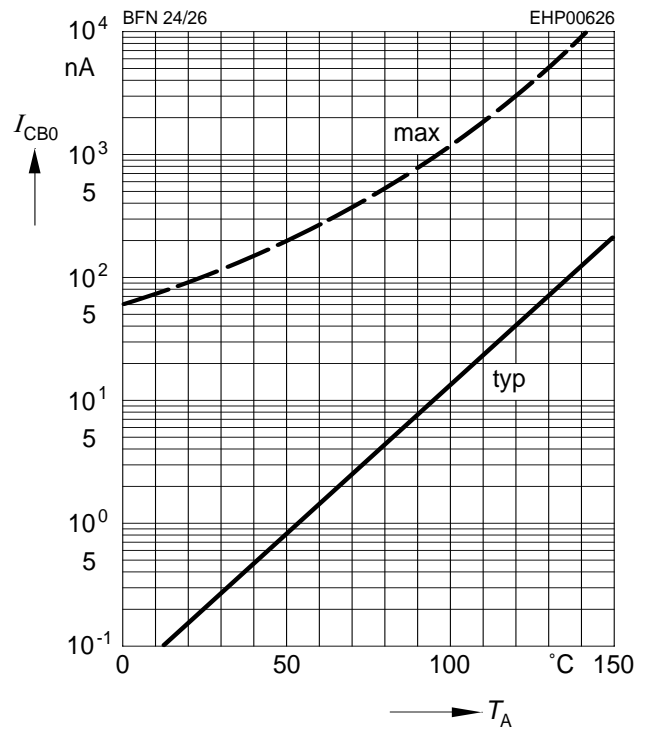

**DC current gain  $h_{FE} = f(I_C)$**

$V_{CE} = 10V$

