

**NDP708A / NDP708AE / NDP708B / NDP708BE**  
**NDB708A / NDB708AE / NDB708B / NDB708BE**  
**N-Channel Enhancement Mode Field Effect Transistor**

**General Description**

These N-channel enhancement mode power field effect transistors are produced using Fairchild's proprietary, high cell density, DMOS technology. This very high density process has been especially tailored to minimize on-state resistance, provide superior switching performance, and withstand high energy pulses in the avalanche and commutation modes. These devices are particularly suited for low voltage applications such as automotive, DC/DC converters, PWM motor controls, and other battery powered circuits where fast switching, low in-line power loss, and resistance to transients are needed.

**Features**

- 60 and 54A, 80V.  $R_{DS(ON)} = 0.022$  and  $0.025\Omega$ .
- Critical DC electrical parameters specified at elevated temperature.
- Rugged internal source-drain diode can eliminate the need for an external Zener diode transient suppressor.
- 175°C maximum junction temperature rating.
- High density cell design (3 million/in<sup>2</sup>) for extremely low  $R_{DS(ON)}$ .
- TO-220 and TO-263 (D<sup>2</sup>PAK) package for both through hole and surface mount applications.

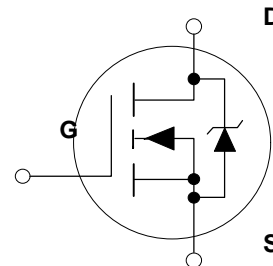
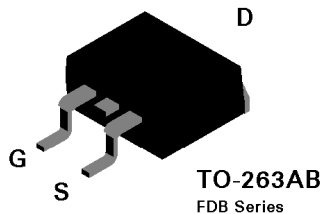
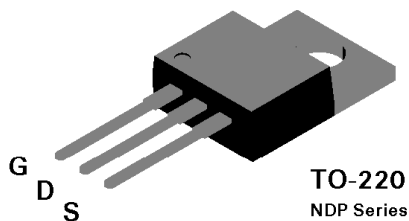

**Absolute Maximum Ratings**

$T_c = 25^\circ\text{C}$  unless otherwise noted

Symbol	Parameter	NDP708A NDP708AE	NDP708B NDP708BE	Units
		NDB708A NDB708AE	NDB708B NDB708BE	
$V_{DSS}$	Drain-Source Voltage	80		V
$V_{DGR}$	Drain-Gate Voltage ( $R_{GS} \leq 1\text{ M}\Omega$ )	80		V
$V_{GSS}$	Gate-Source Voltage - Continuous	$\pm 20$		V
	- Nonrepetitive ( $t_p < 50\ \mu\text{s}$ )	$\pm 40$		V
$I_D$	Drain Current - Continuous	60	54	A
	- Pulsed	180	162	A
$P_D$	Total Power Dissipation @ $T_c = 25^\circ\text{C}$	150		W
	Derate above $25^\circ\text{C}$	1		W/ $^\circ\text{C}$
$T_J, T_{STG}$	Operating and Storage Temperature Range	-65 to 175		$^\circ\text{C}$
$T_L$	Maximum lead temperature for soldering purposes, 1/8" from case for 5 seconds	275		$^\circ\text{C}$

## Electrical Characteristics (T<sub>c</sub> = 25°C unless otherwise noted)

Symbol	Parameter	Conditions	Type	Min	Typ	Max	Units
<b>DRAIN-SOURCE AVALANCHE RATINGS</b> (Note 1)							
E <sub>AS</sub>	Single Pulse Drain-Source Avalanche Energy	V <sub>DD</sub> = 25 V, I <sub>D</sub> = 60 A	NDP708AE NDP708BE			600	mJ
I <sub>AR</sub>	Maximum Drain-Source Avalanche Current		NDB708AE NDB708BE			60	A
<b>OFF CHARACTERISTICS</b>							
BV <sub>DSS</sub>	Drain-Source Breakdown Voltage	V <sub>GS</sub> = 0 V, I <sub>D</sub> = 250 μA	ALL	80			V
I <sub>DSS</sub>	Zero Gate Voltage Drain Current	V <sub>DS</sub> = 80 V, V <sub>GS</sub> = 0 V	ALL			250	μA
		T <sub>J</sub> = 125°C				1	mA
I <sub>GSSF</sub>	Gate - Body Leakage, Forward	V <sub>GS</sub> = 20 V, V <sub>DS</sub> = 0 V	ALL			100	nA
I <sub>GSSR</sub>	Gate - Body Leakage, Reverse	V <sub>GS</sub> = -20 V, V <sub>DS</sub> = 0 V	ALL			-100	nA
<b>ON CHARACTERISTICS</b> (Note 2)							
V <sub>GS(th)</sub>	Gate Threshold Voltage	V <sub>DS</sub> = V <sub>GS</sub> , I <sub>D</sub> = 250 μA	ALL	2	2.6	4	V
		T <sub>J</sub> = 125°C		1.4	1.9	3.6	V
R <sub>DS(on)</sub>	Static Drain-Source On-Resistance	V <sub>GS</sub> = 10 V, I <sub>D</sub> = 30 A	NDP708A NDP708AE NDB708A NDB708AE		0.016	0.022	Ω
		T <sub>J</sub> = 125°C			0.025	0.04	Ω
		V <sub>GS</sub> = 10 V, I <sub>D</sub> = 27 A	NDP708B NDP708BE NDB708B NDB708BE			0.25	Ω
		T <sub>J</sub> = 125°C				0.044	Ω
I <sub>D(on)</sub>	On-State Drain Current	V <sub>GS</sub> = 10 V, V <sub>DS</sub> = 10 V	NDP708A NDP708AE NDB708A NDB708AE	60			A
			NDP708B NDP708BE NDB708B NDB708BE	54			A
g <sub>FS</sub>	Forward Transconductance	V <sub>DS</sub> = 10 V, I <sub>D</sub> = 30 A	ALL	16	33		S
<b>DYNAMIC CHARACTERISTICS</b>							
C <sub>iss</sub>	Input Capacitance	V <sub>DS</sub> = 25 V, V <sub>GS</sub> = 0 V, f = 1.0 MHz	ALL		2800	3600	pF
C <sub>oss</sub>	Output Capacitance		ALL		780	1000	pF
C <sub>rss</sub>	Reverse Transfer Capacitance		ALL		285	400	pF

## Electrical Characteristics (T<sub>c</sub> = 25°C unless otherwise noted)

Symbol	Parameter	Conditions	Type	Min	Typ	Max	Units	
<b>SWITCHING CHARACTERISTICS</b> (Note 2)								
t <sub>D(ON)</sub>	Turn - On Delay Time	V <sub>DD</sub> = 40 V, I <sub>D</sub> = 60 A, V <sub>GS</sub> = 10 V, R <sub>GEN</sub> = 5 Ω	ALL		15	25	nS	
t <sub>r</sub>	Turn - On Rise Time		ALL		143	230	nS	
t <sub>D(OFF)</sub>	Turn - Off Delay Time		ALL		58	90	nS	
t <sub>f</sub>	Turn - Off Fall Time		ALL		108	180	nS	
Q <sub>g</sub>	Total Gate Charge	V <sub>DS</sub> = 64 V, I <sub>D</sub> = 60 A, V <sub>GS</sub> = 10 V	ALL		94	130	nC	
Q <sub>gs</sub>	Gate-Source Charge		ALL		16		nC	
Q <sub>gd</sub>	Gate-Drain Charge		ALL		51		nC	
<b>DRAIN-SOURCE DIODE CHARACTERISTICS</b>								
I <sub>S</sub>	Maximum Continuous Drain-Source Diode Forward Current		NDP708A NDP708AE NDB708A NDB708AE			60	A	
			NDP708B NDP708BE NDB708B NDB708BE			54	A	
I <sub>SM</sub>	Maximum Pulsed Drain-Source Diode Forward Current		NDP708A NDP708AE NDB708A NDB708AE			180	A	
			NDP708B NDP708BE NDB708B NDB708BE			162	A	
V <sub>SD</sub> (Note 2)	Drain-Source Diode Forward Voltage	V <sub>GS</sub> = 0 V, I <sub>S</sub> = 30 A		T <sub>J</sub> = 125°C		0.91	1.3	V
						0.82	1.2	V
t <sub>rr</sub>	Reverse Recovery Time	V <sub>GS</sub> = 0 V, I <sub>S</sub> = 60 A, di <sub>s</sub> /dt = 100 A/μs	ALL		98	140	ns	
I <sub>rr</sub>	Reverse Recovery Current		ALL		6.5	10	A	
<b>THERMAL CHARACTERISTICS</b>								
R <sub>θJC</sub>	Thermal Resistance, Junction-to-Case		ALL			1	°C/W	
R <sub>θJA</sub>	Thermal Resistance, Junction-to-Ambient		ALL			62.5	°C/W	

Notes:

1. NDP708A/708B and NDB708A/708B are not rated for operation in avalanche mode.
2. Pulse Test: Pulse Width ≤ 300 μs, Duty Cycle ≤ 2.0%.

# Typical Electrical Characteristics

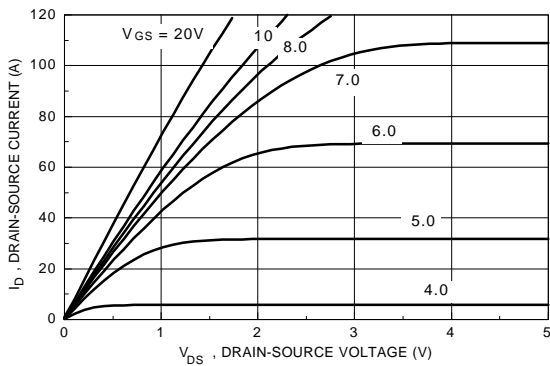

Figure 1. On-Region Characteristics.

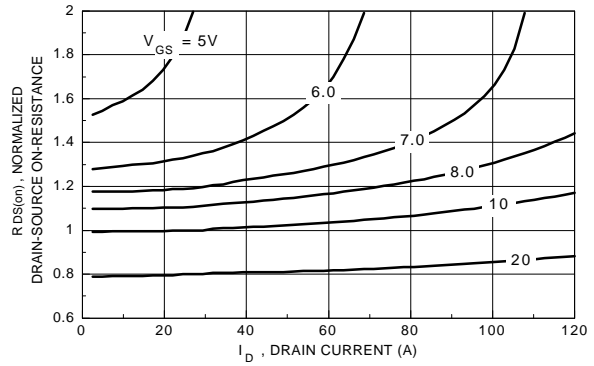

Figure 2. On-Resistance Variation with Gate Voltage and Drain Current.

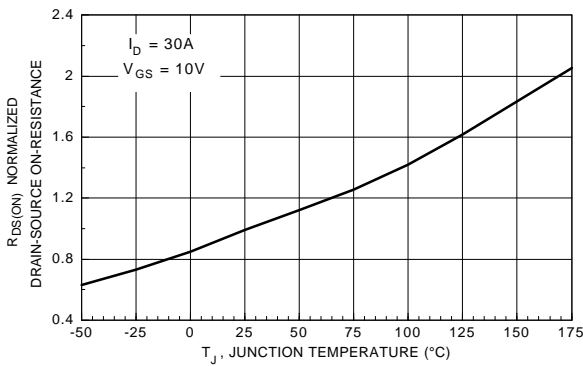

Figure 3. On-Resistance Variation with Temperature.

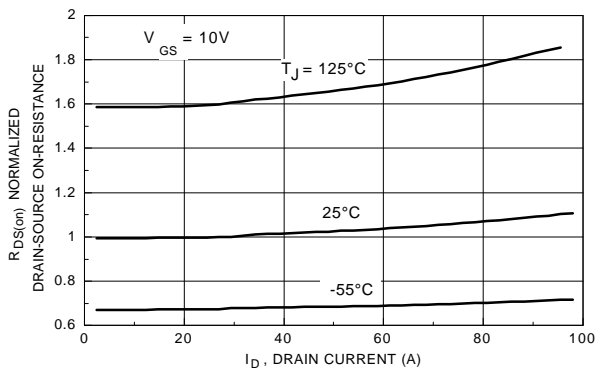

Figure 4. On-Resistance Variation with Drain Current and Temperature.

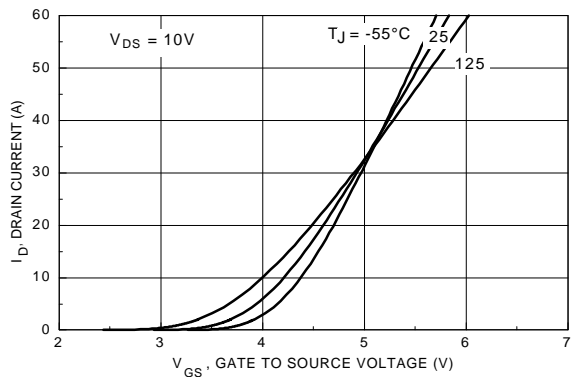

Figure 5. Transfer Characteristics.

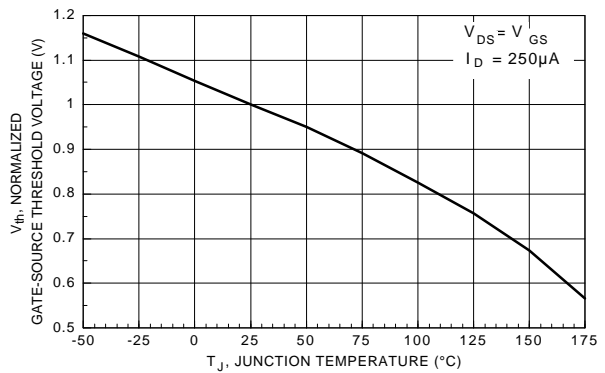
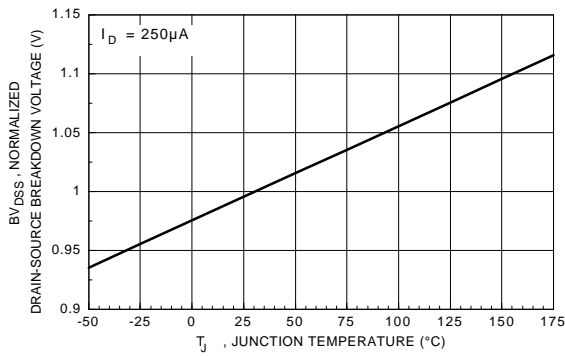
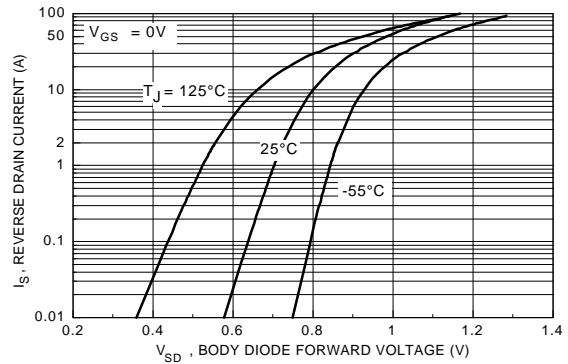

Figure 6. Gate Threshold Variation with Temperature.

## Typical Electrical Characteristics (continued)



**Figure 7. Breakdown Voltage Variation with Temperature.**



**Figure 8. Body Diode Forward Voltage Variation with Current and Temperature.**

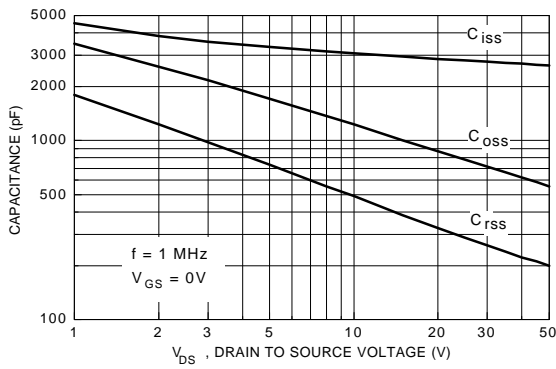

**Figure 9. Capacitance Characteristics.**

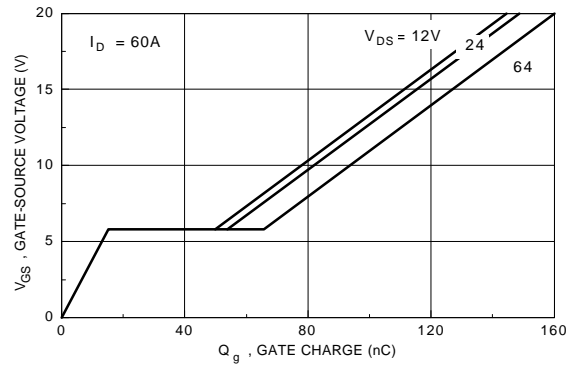

**Figure 10. Gate Charge Characteristics.**

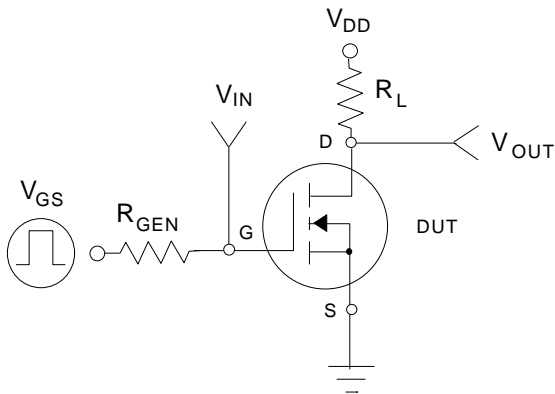

**Figure 11. Switching Test Circuit.**

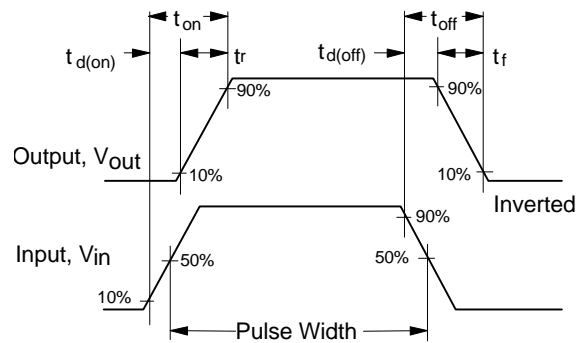

**Figure 12. Switching Waveforms.**

## Typical Electrical Characteristics (continued)

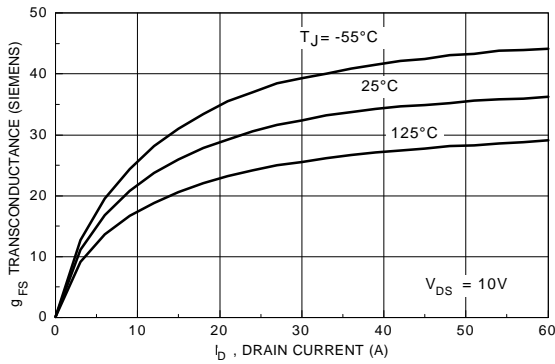

Figure 13. Transconductance Variation with Drain Current and Temperature.

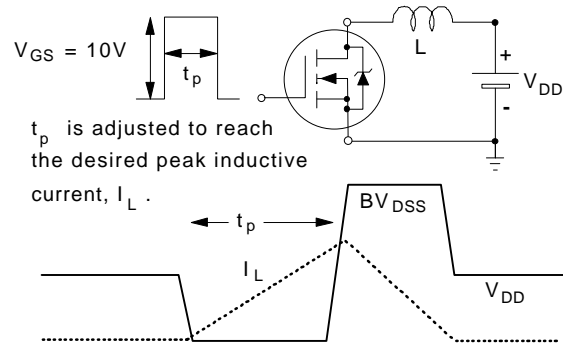

Figure 14. Unclamped Inductive Load Circuit and Waveforms.

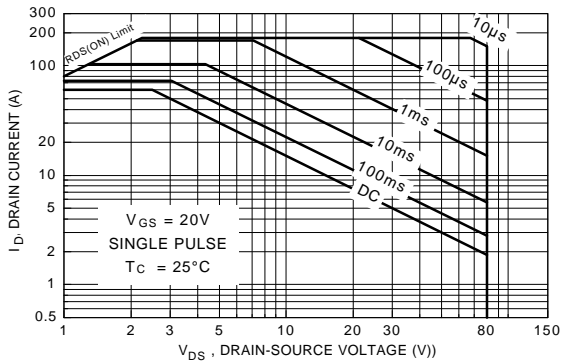

Figure 15. Maximum Safe Operating Area.

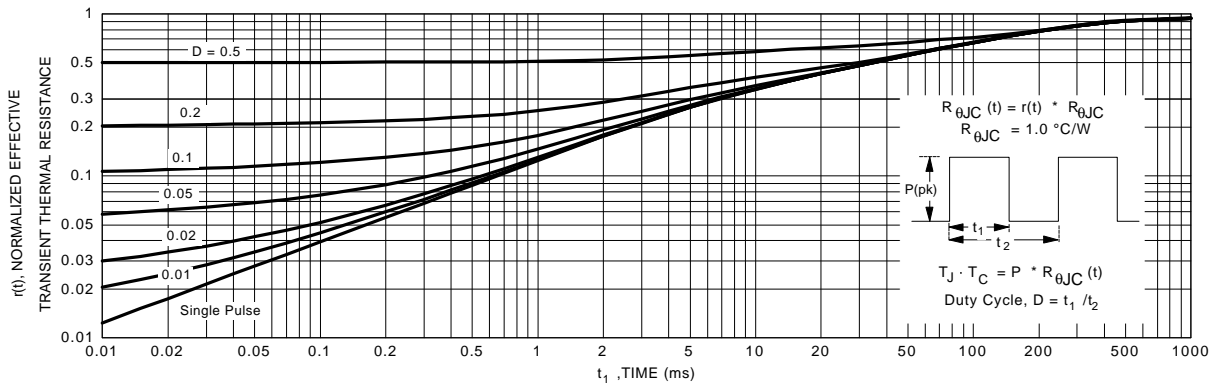

Figure 16. Transient Thermal Response Curve.